

PM180

eXpertMeter™

MULTI-PURPOSE DEVICE FOR MANY APPLICATIONS, INCLUDING:

- ✓ HIGH PERFORMANCE POWER QUALITY ANALYZER (PQA)
- ✓ INDUSTRIAL & SUBSTATION AUTOMATION CONTROLLER WITH IEC 61850 PROTOCOL
- ✓ SEQUENCE OF EVENTS (SOE)
- ✓ DIGITAL FAULT RECORDER (DFR)
- ✓ REVENUE GRADE CHECK METER
- ✓ PHASOR MEASUREMENT UNIT (PMU)
- ✓ MOTORS AND LARGE LOAD MONITORING



 SATEC



PM180

eXpertMeter™

SATEC eXpertMeter™ PM180 is a high performance analyzer that allows versatile uses. The high performance of the PM180, together with the unique flexible design of the expansion cards and the versatile installation on DIN rail, 4" round or 92x92mm cutout, enables its use in a large variety of applications, in which it can substitute several other devices—saving costs, space and complexity.

Wide range of control and alarm options: digital & analog I/O, GPS time sync. and more

Auxiliary PS for redundancy

Standard communication: Ethernet, RS-485, USB & IRIG-B

Four galvanically isolated voltage channels (standard)

Four galvanically isolated current channels up to 20xIn (standard)

50-290V AC, 90-290V DC power supply

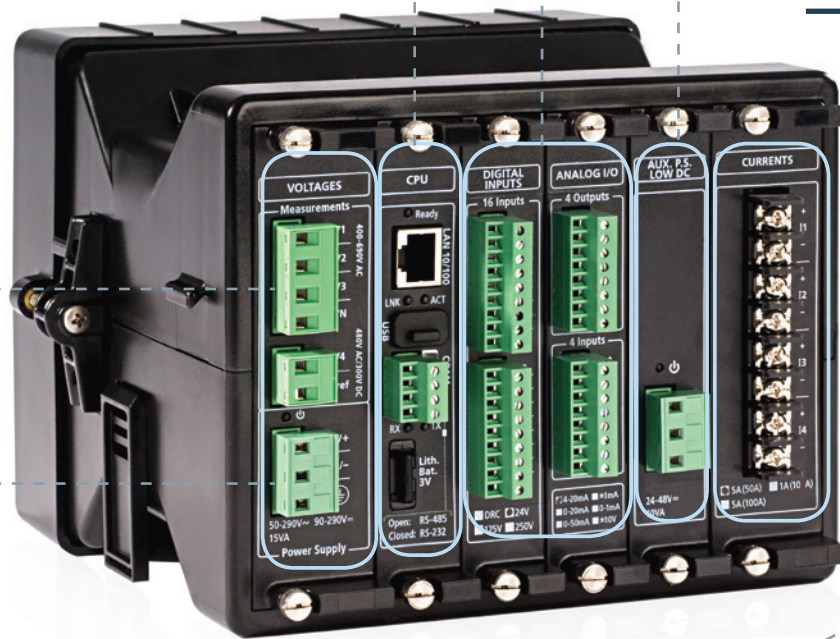

DIN rail, 4" round or 92x92 mm cutout mounting

Accurate distance to fault calculation

Option for fast transient recording (16μSec)

Option for Phasor Measurement Unit (PMU)

Add-on communication options: serial, fiber optic & 2G/3G cellular modules

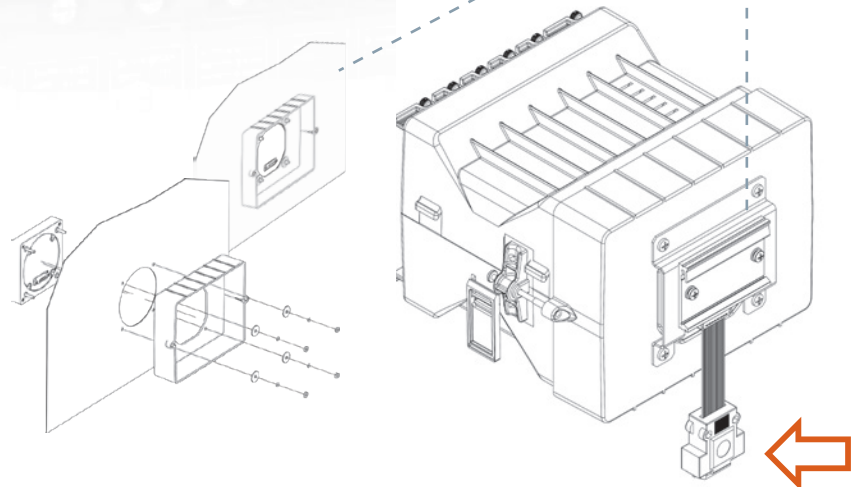

Local & Remote Displays

The PM180 can be connected to a local display, plus up to two remote displays (via RS-485), at the same time. The selection of displays includes LCD or LED display in various configurations.



Modular Field-Installable Design

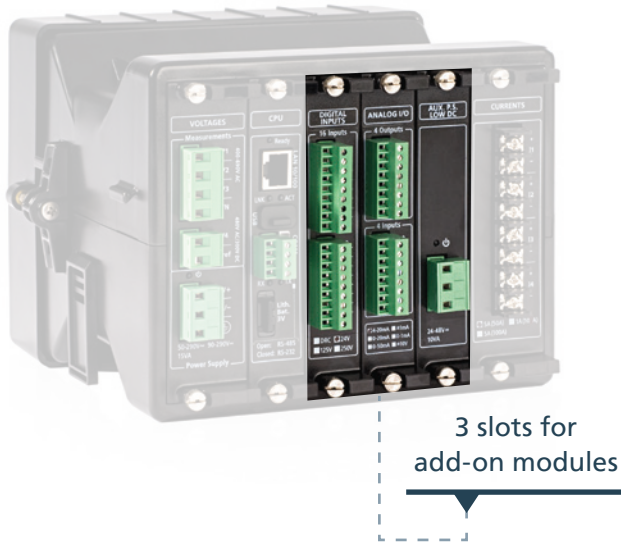

The unique modular design of the PM180 ensures its adaptation to changing needs, through a selection of numerous plug-in options for multiple customer applications. The PM180 can have up to 3 expansions modules.



Digital I/O

16 DIGITAL INPUTS

Max. 48 DI.

Optically isolated dry/wet contact

Scan time: 1ms @ 60Hz, 1.25ms @ 50Hz

24/125/250V DC

8 RELAY OUTPUTS

Max. 24 RO, rated at 8A/250V AC,

5A/24V DC, 0.25A/250V DC

8DI and 8RO

- ▣ 8 inputs bipolar capabilities, optically isolated (dry/wet)
- ▣ 4 relays: option EMR as 8RO, or option SSR

Redundant P.S.

AUXILIARY POWER SUPPLY

- ▣ 50-290V AC and 40-290V DC, 20W
 - ▣ 9.6-35 V DC, 20W
- (max. one aux. power supply per PM180)

Analog I/O

Accuracy Class 0.2S FS

Scan/update time: 2 cycles

4AI & 4AO (Max. 12AI / 12AO)

Ranges: $\pm 1\text{mA}$, 0-20mA, 0-1mA, 4-20mA

4AI (Max. 12AI)

Range: $\pm 10\text{V}$

Communication

IRIG-B MODULE

- ▣ Optically isolated IRIG-B port
- ▣ Second RS-422/485 COM port

TXFX MODULE

- ▣ Redundant Ethernet port
- ▣ 10/100 Mbit with RJ45 connector
- ▣ 100Base FX with SC connector

2G/3G CELLULAR MODEM

- ▣ Antenna connection: SMA
- ▣ Supports UMTS/HSPA+ bands: 800/850/900/AWS/1900/2100

Measurement / Fault Channels

FAULT RECORDER MODULE

Additional current input offers separated metering & protection CT connection, records current faults of up to 200A (40*In)

TRANSIENT RECORDER MODULE

Records voltage transients of up to 2kV (L-G) at 1024 samples/cycle per channel

PMU + TRANSIENT MODULE

Phasor measurement and monitoring class P

High Performance Power Quality Analyzer (PQA)

Cutting Edge Power Quality Analyzer & Recorder

The PM180 is the most advanced power quality analyzer and recorder on the market. The instrument is a product of SATEC's 25 years of experience in the creation of power quality instruments. The PM180 is designed to fully comply with the most demanding industry standard, IEC 61000-4-30 Class A. It provides power quality reports and statistics according to IEEE 1159, EN50160, GOST 13109 or GOST 54149, complimented

by comprehensive power quality event/data log with waveforms available for detailed Power Quality event analysis. Redundant power supply allows full readiness for any power quality event, including major dips and interruptions. The individual harmonics and inter-harmonics are analyzed according to IEC 61000-4-7. The instrument also supports directional power harmonics analysis. Flicker is measured and analyzed according to IEC 61000-4-15.



- Power quality analysis and reading according to IEC 61000-4-30 Class A
 - Sags/swells (dips/overvoltages), interruptions, frequency variations, voltage variations
 - Flicker, voltage unbalance, harmonic and interharmonic voltages and currents
 - Programmable thresholds and hysteresis
- Built-in IEEE 1159, EN50160, GOST 13109 or GOST 54149 statistics and reports (market dependant)
- Redundant auxiliary power supply for recording major dips and interruptions
- Harmonics and interharmonics according to IEC 61000-4-7
- Directional power harmonics
- Voltage and current THD coefficients
- Currents TDD coefficients and K-Factors
- Waveform, power factor and phasor data recorder
- Symmetrical components
- Flicker measurement according to IEC 61000-4-15
- Waveform recording
 - Selectable sampling rate up to 256/1024 samples/cycle
- Power quality event recorder
- Event recorder for logging internal diagnostic events, control events and I/O operations

Industrial & Substation

Automation Controller with IEC 61850 Protocol

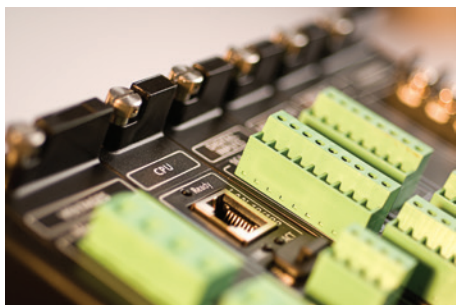

SATEC's PM180 is a cost effective solution for electrical substation automation. It can be used either as a bay controller or as a Power Meter with IEC 61850 support.

PM180 as a Bay Controller Unit (BCU)

PM180 provides fully automated control of substation switching devices. After the switches are configured in the device, typically no additional logic is required for controller operation, except for interlocking logic. Bay control solutions are customized via control logic and a variety of digital I/O and analog measurements.

PM180 as Power Meter

By adding a single PM180 device to each feeder, ALL the information required for substation automation is provided. The PM180 extends the life expectancy of electromechanical relays by providing information lacking in electromechanical devices without interfering in the protection scheme.

Features

- Monitoring and control capabilities for 2 circuit breakers and 14 circuit switches
- One-pole and three-pole switch position monitoring using two or six contacts
- One control output for switch closing
- Two synchronous control outputs for switch opening for devices with one and two opening coils
- Select-close control output for secure switch closing operations
- Two select-open control outputs for secure switch opening operations
- Configurable command pulse duration
- Option for adaptive pulses controlled via setpoint control logic
- Supervision of command execution & reporting on operation termination
- Interlocking logic
- Secure timed-out interlocking bypass logic
- Indication of non-controllable breaker trips
- Switch position substitution option
- Counting of breaker and switch operations
- Logging close/open operations and switch position changes
- Local switch control via setpoint control logic
- Remote switch control and monitoring via Modbus and IEC 61850 protocols
- Inter-device IEC 61850 GOOSE communications for remote interlocking
- Supported IEC 61850 sections (completely or partially): -1, -2, -3, -4, -5, -6, -7-2, -7-3, -7-4, -8, -10
- Configuration of IEC 61850: IEC 61850 IED Properties, IEC 61850 Datasets, IEC 61850 Reports, GOOSE Publisher Setup, GOOSE Subscriber Setup and Report Deadbands
- Configuration tools: PLC configurator based on IEC 61131-3 protocol - using Functional Block Diagram (FBD) or Ladder Diagram (LD)



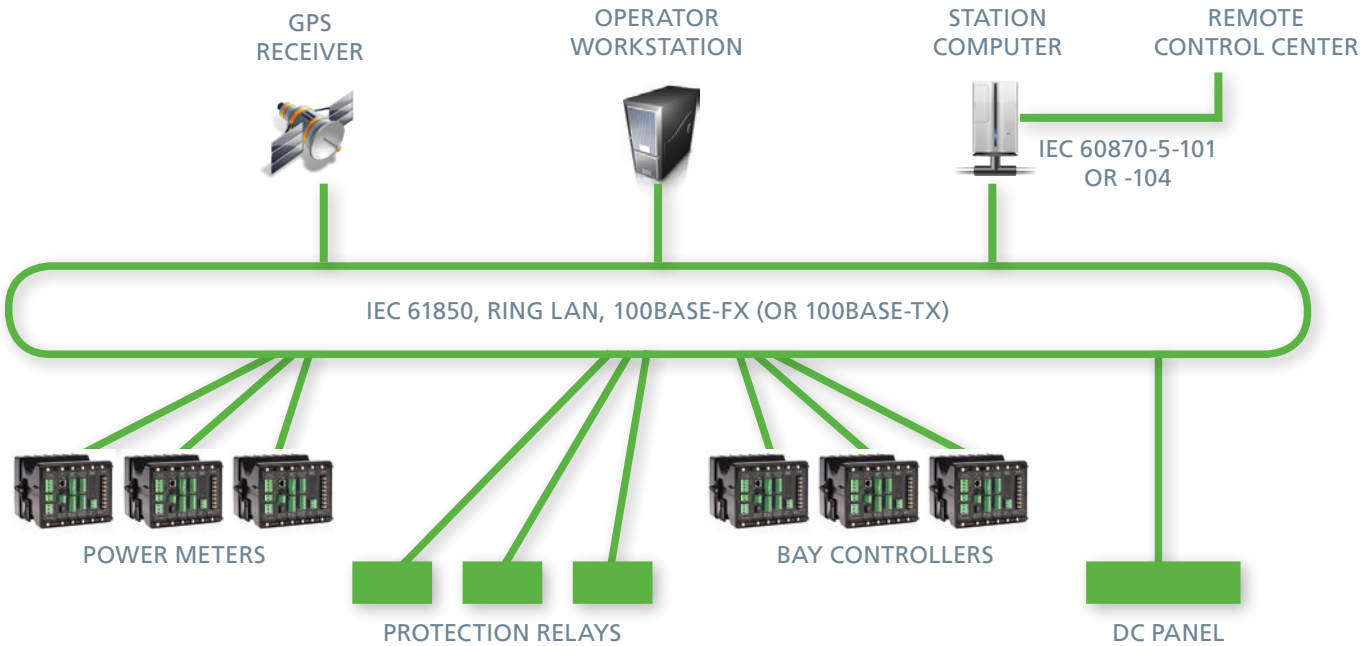

Sequence of Events (SoE)

Designed for an electrical utility substation or industrial environment to record contact openings and closings of field devices, such as electromechanical and microprocessor controlled relays. It includes up to three 16 digital input modules, with up to a total of 48 digital inputs (wet or dry type) with a 1 mSec time resolution between events.

The Sequence of Events (SoE) recorder can log four types of events: digital input events, relay output events, fault events and setpoint events.

When displaying the SoE Log reports, PAS establishes links between the event and other database records where it finds a relationship between the recorded data and the event.

SOE / WAVEFORM COMBINATION

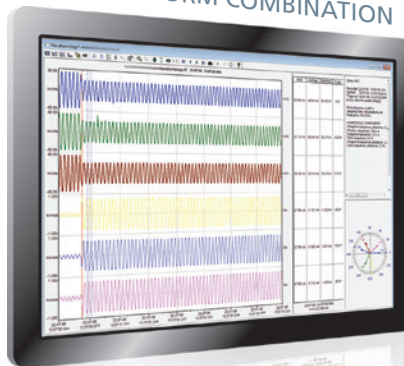

Configuring SoE can be done using the PAS software, or a PLC configurator based on IEC 61131-3 protocol, a standard protocol language to configure the PM180 using Functional Block Diagram (FBD) or Ladder Diagram (LD).

SEQUENCE OF EVENTS LOG

This screenshot shows a "SEQUENCE OF EVENTS LOG" interface. It displays a table with columns for time, event type, and description. The table contains multiple rows of event data, including timestamps and event descriptions such as "DIGITAL INPUT CHANGE", "RELAY OUTPUT CHANGE", and "FAULT EVENT".

Time	Event Type	Description
15:02:01.154	DI	DI000001 Transformer #1
15:02:01.154	DI	DI000002 Transformer #1
15:02:01.154	DI	DI000003 Transformer #1
15:02:01.154	DI	DI000004 Transformer #1
15:02:01.154	DI	DI000005 Transformer #1
15:02:01.154	DI	DI000006 Transformer #1
15:02:01.154	DI	DI000007 Transformer #1
15:02:01.154	DI	DI000008 Transformer #1
15:02:01.154	DI	DI000009 Transformer #1
15:02:01.154	DI	DI000010 Transformer #1
15:02:01.154	DI	DI000011 Transformer #1
15:02:01.154	DI	DI000012 Transformer #1
15:02:01.154	DI	DI000013 Transformer #1
15:02:01.154	DI	DI000014 Transformer #1
15:02:01.154	DI	DI000015 Transformer #1
15:02:01.154	DI	DI000016 Transformer #1
15:02:01.154	DI	DI000017 Transformer #1
15:02:01.154	DI	DI000018 Transformer #1
15:02:01.154	DI	DI000019 Transformer #1
15:02:01.154	DI	DI000020 Transformer #1
15:02:01.154	DI	DI000021 Transformer #1
15:02:01.154	DI	DI000022 Transformer #1
15:02:01.154	DI	DI000023 Transformer #1
15:02:01.154	DI	DI000024 Transformer #1
15:02:01.154	DI	DI000025 Transformer #1
15:02:01.154	DI	DI000026 Transformer #1
15:02:01.154	DI	DI000027 Transformer #1
15:02:01.154	DI	DI000028 Transformer #1
15:02:01.154	DI	DI000029 Transformer #1
15:02:01.154	DI	DI000030 Transformer #1
15:02:01.154	DI	DI000031 Transformer #1
15:02:01.154	DI	DI000032 Transformer #1
15:02:01.154	DI	DI000033 Transformer #1
15:02:01.154	DI	DI000034 Transformer #1
15:02:01.154	DI	DI000035 Transformer #1
15:02:01.154	DI	DI000036 Transformer #1
15:02:01.154	DI	DI000037 Transformer #1
15:02:01.154	DI	DI000038 Transformer #1
15:02:01.154	DI	DI000039 Transformer #1
15:02:01.154	DI	DI000040 Transformer #1
15:02:01.154	DI	DI000041 Transformer #1
15:02:01.154	DI	DI000042 Transformer #1
15:02:01.154	DI	DI000043 Transformer #1
15:02:01.154	DI	DI000044 Transformer #1
15:02:01.154	DI	DI000045 Transformer #1
15:02:01.154	DI	DI000046 Transformer #1
15:02:01.154	DI	DI000047 Transformer #1
15:02:01.154	DI	DI000048 Transformer #1
15:02:01.154	DI	DI000049 Transformer #1
15:02:01.154	DI	DI000050 Transformer #1
15:02:01.154	DI	DI000051 Transformer #1
15:02:01.154	DI	DI000052 Transformer #1
15:02:01.154	DI	DI000053 Transformer #1
15:02:01.154	DI	DI000054 Transformer #1
15:02:01.154	DI	DI000055 Transformer #1
15:02:01.154	DI	DI000056 Transformer #1
15:02:01.154	DI	DI000057 Transformer #1
15:02:01.154	DI	DI000058 Transformer #1
15:02:01.154	DI	DI000059 Transformer #1
15:02:01.154	DI	DI000060 Transformer #1
15:02:01.154	DI	DI000061 Transformer #1
15:02:01.154	DI	DI000062 Transformer #1
15:02:01.154	DI	DI000063 Transformer #1
15:02:01.154	DI	DI000064 Transformer #1
15:02:01.154	DI	DI000065 Transformer #1
15:02:01.154	DI	DI000066 Transformer #1
15:02:01.154	DI	DI000067 Transformer #1
15:02:01.154	DI	DI000068 Transformer #1
15:02:01.154	DI	DI000069 Transformer #1
15:02:01.154	DI	DI000070 Transformer #1
15:02:01.154	DI	DI000071 Transformer #1
15:02:01.154	DI	DI000072 Transformer #1
15:02:01.154	DI	DI000073 Transformer #1
15:02:01.154	DI	DI000074 Transformer #1
15:02:01.154	DI	DI000075 Transformer #1
15:02:01.154	DI	DI000076 Transformer #1
15:02:01.154	DI	DI000077 Transformer #1
15:02:01.154	DI	DI000078 Transformer #1
15:02:01.154	DI	DI000079 Transformer #1
15:02:01.154	DI	DI000080 Transformer #1
15:02:01.154	DI	DI000081 Transformer #1
15:02:01.154	DI	DI000082 Transformer #1
15:02:01.154	DI	DI000083 Transformer #1
15:02:01.154	DI	DI000084 Transformer #1
15:02:01.154	DI	DI000085 Transformer #1
15:02:01.154	DI	DI000086 Transformer #1
15:02:01.154	DI	DI000087 Transformer #1
15:02:01.154	DI	DI000088 Transformer #1
15:02:01.154	DI	DI000089 Transformer #1
15:02:01.154	DI	DI000090 Transformer #1
15:02:01.154	DI	DI000091 Transformer #1
15:02:01.154	DI	DI000092 Transformer #1
15:02:01.154	DI	DI000093 Transformer #1
15:02:01.154	DI	DI000094 Transformer #1
15:02:01.154	DI	DI000095 Transformer #1
15:02:01.154	DI	DI000096 Transformer #1
15:02:01.154	DI	DI000097 Transformer #1
15:02:01.154	DI	DI000098 Transformer #1
15:02:01.154	DI	DI000099 Transformer #1
15:02:01.154	DI	DI000100 Transformer #1

Digital Fault Recording (DFR)

SATEC PM180 includes true Digital Fault Recording and Disturbance Recording. The standard device includes four current channels for up to 20xIn (100A @ In=5A) of fault currents. Adding the DFR module (page 4) allows for separated connection of measurement CTs and protection CTs of up to 40xIn (200A). Three AC voltage channels and one AC/DC measurement input channels are also included. Multiple PM180 devices can cross trigger for up to 20 cycles of pre-fault information for distributed recording. Fault information can be exported to PQDIF/COMTRADE format via PAS software.

The fault recorder provides 4 measured and recorded currents (including measured neutral current). The event log is complemented by waveform recording.

PAS FAULT LOG REPORT

No.	Date/Time	Event	Fault Category	Phase	Amps	P	Q	Vrms
1	09/05/04 16:14:25.471	FE21020	Zero-seq. Voltage	L1	1165.34	5.83	23096.0	0.9
2	09/05/04 16:14:25.471	FE21020	Zero-seq. Voltage	L2	0.00	0.00	23091.0	0.9
3	09/05/04 16:14:25.471	FE21020	Zero-seq. Voltage	L3	0.00	0.00	23091.0	0.9
4	09/05/04 16:14:25.471	FE21020	Zero-seq. Voltage	LN	1165.34	5.83	23096.0	0.9
5	09/05/04 16:14:27.475	FE21021	External Trigger	L1	0.00	0.00	23035.0	0.9
6	09/05/04 16:14:27.475	FE21021	External Trigger	L2	0.00	0.00	23032.0	0.9
7	09/05/04 16:14:27.475	FE21022	External Trigger	L3	0.00	0.00	23035.0	0.9
8	09/05/04 16:14:27.475	FE21022	External Trigger	LN	0.00	0.00	23032.0	0.9
9	09/05/04 16:14:27.715	FE21022	Current Unbalance	L1	0.00	0.00	23009.0	0.9
10	09/05/04 16:14:27.715	FE21022	Current Unbalance	L2	0.00	0.00	23007.0	0.9
11	09/05/04 16:14:27.715	FE21022	Current Unbalance	L3	0.00	0.00	23007.0	0.9
12	09/05/04 16:14:27.715	FE21022	Current Unbalance	LN	34.75	0.17	23118.0	0.9
13	09/05/04 16:14:27.715	FE21022	Current Unbalance	L1	0.00	0.00	23073.0	0.9
14	09/05/04 16:14:27.715	FE21022	Current Unbalance	L2	0.00	0.00	23074.0	0.9
15	09/05/04 16:14:27.715	FE21022	Current Unbalance	L3	0.00	0.00	23074.0	0.9
16	09/05/04 16:14:27.715	FE21022	Current Unbalance	LN	1085.63	5.43	23074.0	0.9
17	09/05/04 16:14:28.004	FE21024	Zero-seq. Voltage	L1	0.00	0.00	22230.0	0.9
18	09/05/04 16:14:28.004	FE21024	Zero-seq. Voltage	L2	0.00	0.00	22235.0	0.9
19	09/05/04 16:14:28.004	FE21024	Zero-seq. Voltage	L3	0.00	0.00	22235.0	0.9
20	09/05/04 16:14:28.004	FE21024	Zero-seq. Voltage	LN	90.46	0.45	22925.0	0.9
21	09/05/04 16:14:28.004	FE21024	Current Unbalance	L1	0.00	0.00	22945.0	0.9
22	09/05/04 16:14:28.004	FE21024	Current Unbalance	L2	0.00	0.00	23141.0	0.9
23	09/05/04 16:14:28.004	FE21024	Current Unbalance	L3	0.00	0.00	23141.0	0.9
24	09/05/04 16:14:28.004	FE21024	Current Unbalance	LN	41.45	0.21	23016.0	0.9
25	09/05/04 16:14:28.004	FE21024	Overcurrent	L1	0.00	0.00	24075.0	0.9
26	09/05/04 16:14:28.004	FE21024	Overcurrent	L2	0.00	0.00	23185.0	0.9
27	09/05/04 16:14:28.004	FE21024	Overcurrent	L3	0.00	0.00	23185.0	0.9
28	09/05/04 16:14:28.004	FE21024	Overcurrent	LN	134.20	0.67	23971.0	0.9
29	09/05/04 16:18:04.111	FE21027	Zero-seq. Voltage	L1	0.00	0.00	22298.0	0.9
30	09/05/04 16:18:04.111	FE21027	Zero-seq. Voltage	L2	0.00	0.00	22241.0	0.9
31	09/05/04 16:18:04.111	FE21027	Zero-seq. Voltage	L3	0.00	0.00	22241.0	0.9
32	09/05/04 16:18:04.111	FE21027	Zero-seq. Voltage	LN	25.33	0.13	23034.0	0.9
33	09/05/04 16:18:04.844	FE21028	Voltage Unbalance	L1	0.00	0.00	22935.0	0.9
34	09/05/04 16:18:04.844	FE21028	Voltage Unbalance	L2	0.00	0.00	23005.0	0.9
35	09/05/04 16:18:04.844	FE21028	Voltage Unbalance	L3	0.00	0.00	23005.0	0.9
36	09/05/04 16:18:04.844	FE21028	Voltage Unbalance	LN	25.11	0.13	23032.0	0.9
37	09/05/04 16:18:04.844	FE21029	Overcurrent	L1	0.00	0.00	22932.0	0.9
38	09/05/04 16:18:04.844	FE21029	Overcurrent	L2	0.00	0.00	22929.0	0.9
39	09/05/04 16:18:04.844	FE21029	Overcurrent	L3	0.00	0.00	22929.0	0.9
40	09/05/04 16:18:04.844	FE21029	Overcurrent	LN	20.25	0.10	23276.0	0.9
41	09/05/04 16:18:04.210	FE21031	Voltage Unbalance	L1	0.00	0.00	23287.0	0.9
42	09/05/04 16:18:04.210	FE21031	Voltage Unbalance	L2	0.00	0.00	23287.0	0.9
43	09/05/04 16:18:04.210	FE21031	Voltage Unbalance	L3	0.00	0.00	23287.0	0.9
44	09/05/04 16:18:04.210	FE21031	Voltage Unbalance	LN	116.84	0.58	23227.0	0.9
45	09/05/04 16:18:04.618	FE21032	Voltage Unbalance	L1	0.00	0.00	22852.0	0.9
46	09/05/04 16:18:04.618	FE21032	Voltage Unbalance	L2	0.00	0.00	22852.0	0.9
47	09/05/04 16:18:04.618	FE21032	Voltage Unbalance	L3	0.00	0.00	22852.0	0.9
48	09/05/04 16:18:04.618	FE21032	Voltage Unbalance	LN	0.00	0.00	22852.0	0.9

Viewing the Fault Log

Fault log files are displayed in a tabular view, one event per row. PAS loads the entire database table to a window so that you can scroll through the entire log to view its contents or a particular event loaded from the PM180 separately (for fast loading fault).

PAS POWER QUALITY SETUP

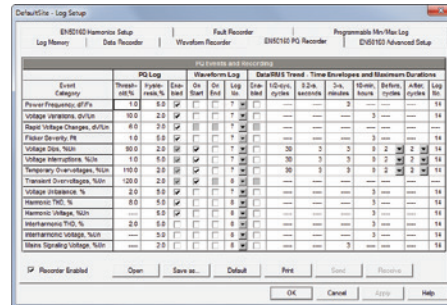

The Fault Recorder can be triggered by the embedded fault detector or externally through any digital input. External triggers are automatically enabled for the Fault Recorder.

When the Fault Recorder is enabled, it automatically records all internally detected and externally triggered fault

PAS FAULT RECORDER SETUP

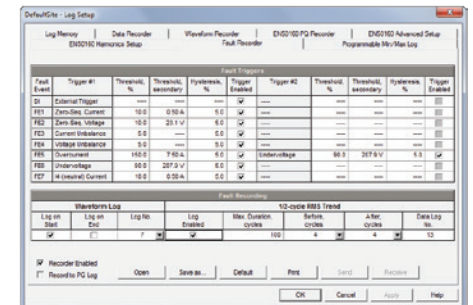

events to the Fault Log file and to the Sequence Of Events Log (see pg. 8).

The Fault Recorder setup allows you to adjust thresholds and hysteresis for different fault triggers, and to define the waveform and data log options for recording fault events.

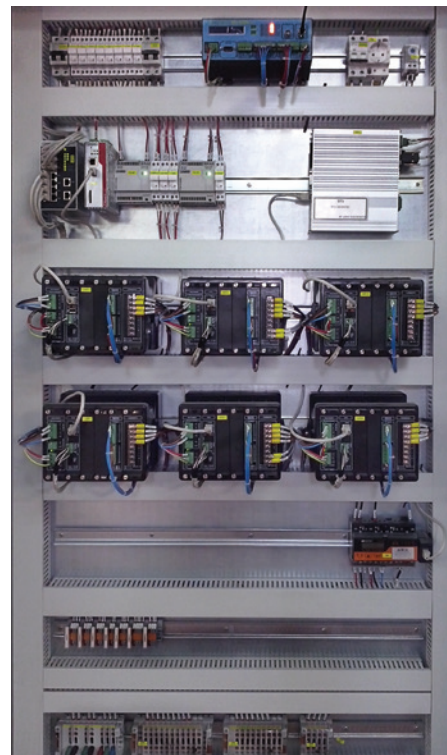

Features

- IRIG-B/SNTP/DI time synchronization
- 256 MB memory
- Programmable fault thresholds and hysteresis
- Up to 200 Amps fault currents (40xIn)
- Separate measurement and protection CT connection (option)
- Zero-sequence currents and voltages
- Current and voltage unbalance
- Under-voltage, neutral current
- Ready-for-use fault reports—fault currents magnitude and duration, coincident volts magnitude, fault waveforms and RMS trace
- Distance to fault calculation
- Waveforms from multiple separate locations (via PAS)

Phasor Measurement Unit (PMU)

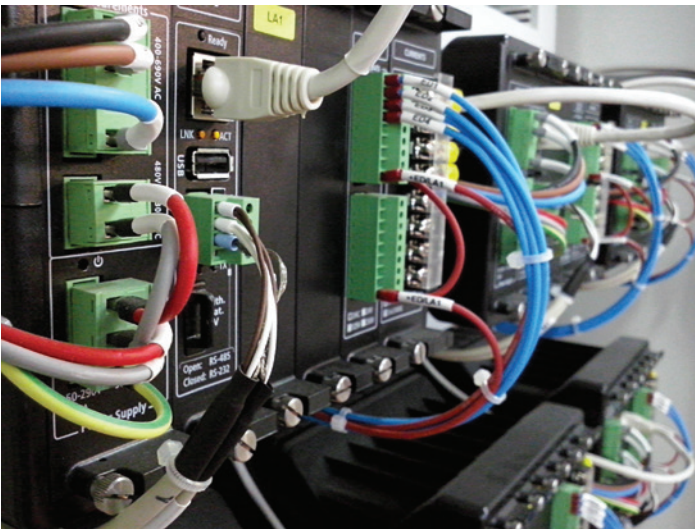

The PM180 Phasor Measurement Unit (PMU) module provides synchrophasor and frequency measurements compliant with the IEEE C37.118.1 P performance class, as well as real-time cyclic exchange of synchronized phasor data with the substation phasor data concentrator (PDC) based on the IEC 61850-9-2 Sampled Value (SV) service.

Features

- IEEE C37.118.1 P class performance compliance
- IEEE C37.118.1 three-phase voltage and current phasor measurements synchronized to a common UTC time reference, e.g. GPS, connected through the onboard IRIG-B time code signal decoder
- IEEE C37.118.1 synchronous frequency and Rate of Change of Frequency (ROCOF) measurements
- Expected total vector error (TVE) less than 0.5%
- Streaming of phasor data over Ethernet using the IEC 61850-9-2 multicast sampled value (SV) service
- Streaming rate from 1 to 50 or 60 frames/s at 50 or 60Hz, respectively
- IEEE C37.118.2 compliant mapping of synchrophasor data to IEC 61850 sampled values APDU upon IEC 61850-9-2 and IEC 61850-90-5 guidelines

Motors & Large Load Monitoring

Monitoring Large motors

Electrical motors and other large loads are an important part of the electrical equipment and are dominant in the overall consumption. As a result, they significantly affect the energy efficiency and site reliability. Monitoring main motors includes observing their energy consumption, tracking their health and examining their efficiency.

Energy Consumption

Electric motors consume about 50% of the world's energy. It is therefore very important to track their energy consumption. While a basic power meter can do this job, for large motors it is recommended to use a higher accuracy device, with power quality and control functions.

Real-Time Pumps Efficiency Monitoring Application

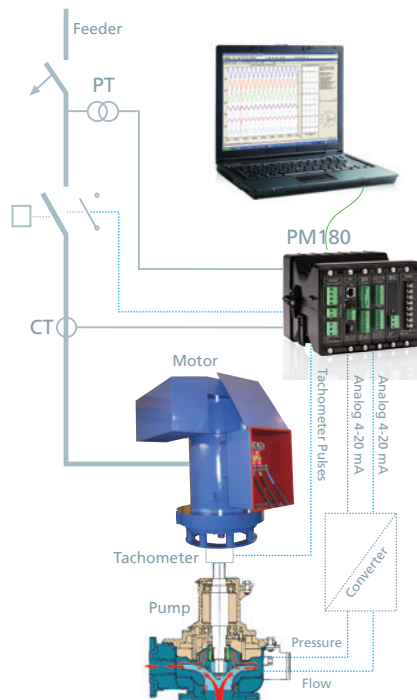

Using the PM180 to measure the electricity consumption, the digital pulse input to read the speed of the motor and the analog inputs to read the flow and pressure allows creating an advanced real-time pump efficiency monitoring.

The pump's efficiency can be calculated ($\text{Efficiency\%} = P_{\text{pump}} / P_E * 100\%$) and the system notifies when the efficiency is too low, which helps in increasing energy efficiency, as well as alerting on potential failures.

Features

- Accurate efficiency monitoring
- A single PM180 device performs all data logging, time synchronized
- Improved reliability
- Allows additional control functions using relay outputs, digital inputs and analog I/O

Motor Reliability & Troubleshooting

Monitoring the power quality of the motor, particularly the harmonics, inter- and sub-harmonics, is a good practice for proactive maintenance. Typically, internal motor damages cause a high level of harmonics, inter- and/or sub-harmonics. Monitoring power quality allows for maintaining motors during a planned shutdown, rather than very expensive unscheduled shutdowns.

Large motor startup may take minutes, while most digital motor protection devices can record for a few seconds only. SATEC PM180 provides continuous logging of up to 3.5 minute waveforms (including up to 20xIn high current), which allows for analyzing failures and for monitoring the motor health, thus improving the facility's reliability.

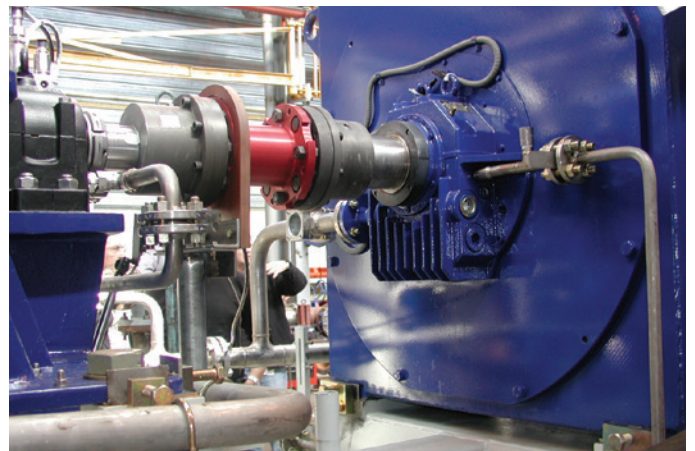

Features

Fast Data Logging Recorder

- From ½ cycle RMS to 2-hour envelopes
- Programmable post fault on any internal and/or external trigger condition

Waveform Capture

- Provides simultaneous capture for all voltage and current channels with choice of sample rate, up to 256 (1024 with Transient Module). Selectable pre-fault / post-fault recording length. Disturbance capture recording up to several minutes
- Transient capture (>78/65µs—50/60Hz)

Harmonic Analyzer

- Total Harmonic Distortion for Voltage and Current and up to the 63rd individual harmonic for V, I, P, Q
- Including directional power harmonics (Load or Source)
- V-I angle, TDD and K factors

Multi-Function Power & Energy Meter

- Real time cycle-by-cycle measurement of high accuracy, true RMS voltage, current, power, demand and energy
- Revenue accurate meter
- Exceeding Class 0.2S (IEC 62053-22 / ANSI C12.20)
- Advanced Time Of Use (TOU) feature (16 Energy sources include external digital pulses, up to 4 seasons, 4 daily profiles, 8 Tariffs, flexible automatic calendar) for any complex billing scheme
- KYZ or KY output and LED indication for calibration and test (via optional display)
- Vector diagram and symmetrical components

Real-Time Clock & Synchronization

- Real-Time Clock with maximum 5 seconds drift per month @ 25°C
- Provides 1 msec time resolution via IRIG-B time code input or satellite clock for common time base (requires IRIG-B module)
- As an SNTP client, it can accept periodic synchronization of the meter clock from an SNTP server
- Time sync from digital input with 1ms accuracy

Wide Range Voltage Inputs

- Three impulse galvanic isolated AC voltage inputs
- Impulse dielectric withstand 6kV
- Wide range application up to 828V
- AC/DC voltage input: station battery monitoring (up to 300V DC)

Wide Range Current Inputs

- 4 dual purpose current inputs (3-phase + Neutral)—1A/5A for measurement CTs with Class 0.2S revenue grade accuracy to 10A/20A and 50A/100A (5A/HACS) for protection CTs (10/20x)

Communication Platforms

- 3 independent built-in Ports plus 3 optional:
 - IRIG-B and RS-422/485 port
 - TFX (fiber optic)
 - 2G/3G cellular modem
- Communication Protocols: Modbus RTU, ASCII, DNP 3.0, Modbus/TCP, DNP3/TCP, IEC 61850 (option), IEC 60870-5-101/104

Digital & Analog I/O Options

3 expansion slots for a wide range of plug-in modules:

- 16 high speed digital inputs, total up to 48 DIs
- 8 dry contact relay outputs, total up to 24 ROs
- Mixed 4 analog inputs and 4 outputs, total up to 12 AI/12AO

Logging, Recording & Programming

- Standard onboard memory: 256 MB
- Programmable controller: up to 64 control setpoints, up to 8 conditions OR, AND, arithmetical functions logic, extensive triggers, programmable thresholds and delays, relay control, event-driven data recording
- 8 fast waveform recorders: simultaneous 8-channel AC, one DC: up to 48 digital inputs in a single plot
- Waveform sampling rate 32, 64, 128 or 256 samples per cycle; up to 20 pre-fault cycles (2 cycles of 1024 samples per cycle or 4 cycles with 512 samples per cycle with Transient Module)
- Up to 3.5 min. of continuous waveform recording
- 1-ms resolution for digital inputs
- 16 fast Data Recorders (16 parameters on each data log): From ½ cycle RMS to 2 hour RMS envelopes; up to 20 pre/post-fault cycles; programmable data logs on a periodic basis and on internal or external trigger
- 32 digital internal counters
- 16 internal programmable timers (½ cycle to 24 hours)

Technical Specifications

INPUT RATINGS

3 Voltage Inputs: V1, V2, V3

- Direct input and input via PT up to 828V AC line-to-line, up to 480V AC line-to-neutral
- Burden for 480V: <0.35 VA
- Burden for 120V: <0.03 VA
- Overvoltage withstand: 1000V AC continuous, 2500V AC for 1 sec.
- Galvanic isolation: 4kV AC / 1 min.
- Impulse dielectric withstand 6kV

Current Inputs: I1, I2, I3, I4

- Selectable 5A or 1A (upon order)
- Operating range: continuous 4xIn ANSI (20A/4A) or 2xIn IEC (10A/2A)
- Fault currents: up to 20xIn (100A @ HACS, 50A @ 5A, 10A @ 1A), max 1 sec.
- Burden for 5A: <0.15 VA;
Burden for 1A: <0.02 VA
- Overload withstand: 4xIn RMS continuous (20A/4A)
- Max. wire size: 10 AWG/6mm²
- Terminals pitch: 13mm
- Galvanic isolation: 4kV AC / 1 min.
- Impulse dielectric withstand 6kV

AC/DC Voltage Input: V4, Vref

- Operating Range: 400V AC
- Direct input and input via PT (up to 480V AC) or Battery input
- Input Impedance: > 10MΩ
- Burden for 400V: << 0.01 VA
- Burden for 120V: << 0.01 VA
- Overvoltage Withstand: 1000V AC continuous, 2500V AC for 1 second
- Resistive Isolation, Insulation withstand: 4kV AC @ 1mn
- Wire Size: 10 AWG (up to 6 mm²)
- Terminals Pitch: 7.5 mm

Power Supplies

- Two redundant galvanically isolated power supplies
- Selection of power supplies:
 - 50-290V AC and 40-290V DC
 - 9.6-35V DC

COMMUNICATION

COM1

- Optically isolated RS-232/485
- Insulation withstand: 4kV AC @ 1 min.
- Connector: removable, captured-wire, 4 terminals
- Max. wire size: 12 AWG / 2.5 mm²
- Max. baud rate: 115,200 bps
- Protocols: MODBUS RTU, MODBUS ASCII, DNP 3.0, IEC 61850 (option), IEC 60870-5-101/104 (option)

COM2

- Optically isolated RS-422/485
- Insulation withstand: 4kV AC @ 1 min.
- Connector: removable, captured-wire, 5 terminals
- Max. wire size: 12 AWG / 2.5 mm²
- Max. baud rate: 115,200 bps
- Protocols: MODBUS RTU, MODBUS ASCII, DNP 3.0

COM3 (Display)

- Optically isolated RS-485 port for the remote display
- Insulation withstand: 2.5kV AC @ 1 min
- Connector: DB15
- Max. baud rate: 115,200 bps.
- Protocols: MODBUS RTU, MODBUS ASCII, DNP 3.0

USB Port

- Isolated USB port
- Insulation withstand: 4kV AC @ 1 min.
- Connector: Type A male
- Supported protocols: MODBUS RTU

Ethernet Port

- Transformer-isolated 10/100 Base-T port
- Insulation withstand: 4kV AC @ 1 min
- Connector: Modular RJ45
- Protocols: MODBUS TCP (Port 502), DNP 3.0/TCP (Port 20000), IEC 61850 (option)
- Number of simultaneous connections (sockets): 5

IRIG-B Port (Option)

- Optically isolated IRIG-B Port
- Time code signal: unmodulated (pulse-width coded)
- Level: unbalanced 5V
- Connector type: BNC
- Recommended cable: 51Ω low loss: RG58A/U (Belden 8219 or equivalent), TNC connector

TX/FX Port (Option)

- Transformer-isolated 10/100Base-T port
- TX Connector: Modular RJ45
- Optical-isolated 100Base FX
- FX Connector: SC
- Supported protocols: MODBUS TCP (Port 502), DNP 3.0/TCP (Port 20000), IEC 61850 (option)
- Number of simultaneous connections (sockets): 5

ENVIRONMENTAL CONDITIONS

- Operating temperature: -22°F to 158°F / -30°C to 70°C
- Storage temperature: -40°F to 185°F / -40°C to 85°C
- Relative humidity: 0-95% non-condensing

DIMENSIONS

- **HxWxD**
 - PM180** 6x8.6x8.3" / 152x220x210 mm
 - RGM180** 7.1x8.7x1.9" / 181x221x48 mm
 - RDM180** 4.5x4.5x0.8" / 114x114x20 mm
 - RDM312** 6.1x12.3x1" / 155x313x26 mm
- **Weight**
 - PM180** 2.5 kg / 5.5 lb
 - RGM180** 0.7 kg / 1.54 lbs

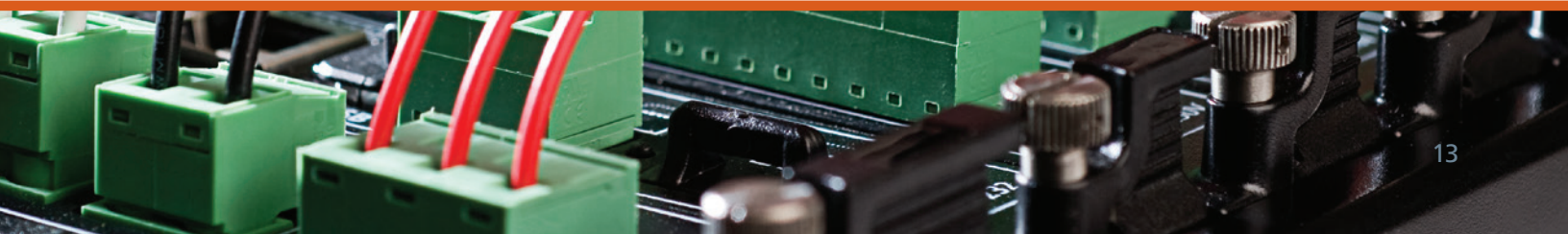

Standards Compliance

- Directive complied with EMC: 89/336/EEC as amended by 92/31/EEC and 93/68/EEC
- LVD: 72/23/EEC as amended by 93/68/EEC and 93/465/EEC
- Harmonized standards to which conformity is declared: EN55011:1991; EN50082 1:1992; EN61010-1:1993; A2/1995
- ANSI C37.90.1 Surge Withstand Capability (SWC)
- EN50081-2 Generic Emission Standard: Industrial Environment
- EN50082-2 Generic Immunity Standard: Industrial Environment
- EN55022: Class A
- IEC 61000-6-2
- IEC 61000-6-4
- IEC 60255-5
- IEC 60255-22

Accuracy

- Active Energy, IEC/AS 62053-22, class 0.25¹
- Reactive Energy, class 0.5S (under conditions as per IEC 62053-22:2003 @ $0 \leq |PF| \leq 0.9$)

Power Quality

- EN50160: Power Quality in European Electricity Supply Networks
- IEEE 1159: Power Quality Recorder in US
- GOST 13109: Electric energy, Electromagnetic compatibility of technical equipment, Power quality limits in public electrical systems

- GOST 54149: 2010: Electric energy, Electromagnetic compatibility of technical equipment, Power quality limits in public electrical systems
- IEC 61000-4-7, Harmonics and inter-harmonics measurement
- IEC 61000-4-15, Flicker measurement
- IEC 61000-4-30 class A, Power quality measurement methods
- IEC 62054-21: Real time clock backup, RTC accuracy $\pm 2\text{ppm}$ @ 23°C

EMC Immunity

- IEC 61000-4-2, IEC 60255-22-2: Electrostatic discharge, 15kV/8kV – air/contact
- IEC 61000-4-3, IEC 60255-22-3: Radiated Immunity, 10V/m and 30V/m @ 80 MHz – 1000 MHz
- IEC 61000-4-4, IEC 60255-22-4: Fast Transients burst, 4KV on current and voltage circuits and 2 KV for auxiliary circuits
- IEC 61000-4-5, IEC 60255-22-5: Surge 6KV on current, voltage circuits and power supply
- IEEE C62.41.2-2002: high voltage line surges
 - 100 kHz ring wave – 6kV @ 0.5kA
 - 1.2/50 microsecond – 8/20 microsecond Combination Wave – 6kV @ 3kA
- IEC 61000-4-6, IEC 62052-11: Conducted Radio-frequency, 10V @ 0.15 MHz – 80MHz
- IEC 61000-4-8: Magnetic Field
- IEC 61000-4-12, IEC 62052-11, IEEE C37.90.1: 2002: Oscillatory waves, CMM 2.5KV & DFM 1KV @ 100KHz and 1MHz

Emission (radiated/conducted)

EN55022, IEC 60255-22: Class A

Construction

Safety

IEC/UL 61010-1

Insulation

- IEC 62052-11: Insulation impulse 6KV/500Ω @ 1.2/50 μs
- IEC 62052-11, IEC 61010-1: AC voltage tests related to ground, 4 kV AC @ 1mn

Atmospheric Environment

- Operational ambient temperature range: –30°C to +70°C
- Long-term damp heat withstand according to IEC 68-2-3 <95%, +40°C
- Transport and storage temperature range: –40°C to +85°C

Vibration

- IEC 60255-21-1: Vibration Response, Table I, Class-2
- IEC 60255-21-1: Vibration Endurance, Table II, Class-1

Mechanical Shock

- IEC 60255-21-2: Shock, Table II, Class-1
- IEC 60255-21-2: Bump, Table III, Class-1

Seismic Vibration

IEC 60255-21-3: Bump, Table III, Class-1

Panel Display protection

IEC 60529: IP54 (NEMA type 13)

Instrument protection

IEC 60529: IP30 (NEMA type 13)

1. Only for PM180-5A and PM180-1A models (internal CT), PM180-DFR model accuracy meets class 1

Measurement Specifications

PARAMETER	FULL SCALE@ INPUT RANGE	ACCURACY			RANGE
		% READING	% FS	CONDITIONS	
Voltage V1-V3	120V x PT ratio @ 120V 400V x PT ratio @ 690V	0.05	0.01	10% to 120% FS	0 to 999,000 V
Line current I1-I4	CT	0.05 0.05 0.05	0.01 0.01	ANSI C12.20: 1%-120% FS 120%-400% FS IEC 62053-22: 1%-200% FS	0 to 120,000 A
Fault current I1- I4	CT	2.0		400%-2000% FS	0 to 120,000 A
AC/DC Voltage	125V / 220V		0.3	10%-120% FS	0 to 290V DC
Active power	0.36 x PT x CT @ 120V 1.2 x PT x CT @ 690V	0.2 0.2	0.002 0.002	PF ≥ 0.5 and ⊕	-10,000 to +10,000 MW
Reactive power	0.36 x PT x CT @ 120V 1.2 x PT x CT @ 690V	0.3 0.3	0.002 0.002	PF ≤ 0.9 and ⊕	-10,000 to +10,000 Mvar
Apparent power	0.36 x PT x CT @ 120V 1.2 x PT x CT @ 690V	0.2 0.2	0.002 0.002	PF ≥ 0.5 and ⊕	0 to 10,000 MVA
Power factor	1.000		0.35	PF ≥ 0.5, I ≥ 2% FSI	-0.999 to +1.000
Frequency	50 Hz 60 Hz	0.002 0.002			40.000 Hz to 64.999 Hz 45.100 Hz to 70.000 Hz
Total Harmonic Distortion, THD V(I), %V _f (%I _f)	100	1.5	0.2	THD ≥ 1% FS, V (I) ≥ 10% FSV (FSI)	0 to 999.99
Total Demand Distortion, TDD, %	100		1.5	TDD ≥ 1% FS, I ≥ 10% FSI	0 to 100
Active Energy Import & Export		Class 0.2 ANSI C12.20, Current class 20 Class 0.2S (IEC 62053-22)			0 to 999,999.999 MWh
Reactive Energy Import & Export		Class 0.2 under conditions as per ANSI C12.20 Class 0.2 under conditions as per IEC 62053-22			0 to 999,999.999 Mvarh
Apparent Energy		Class 0.2 under conditions as per ANSI C12.20 Class 0.2 under conditions as per IEC 62053-22			0 to 999,999.999 MVAh
Volt-Hours		Class 0.2		20%-120% FS	0 to 999,999.999 kWh
Ampere-Hours		Class 0.2		10%-200% FS	0 to 999,999.999 kWh
Symmetrical Components	Voltage FS	1		10%-120% FS	
	Current FS	1		10%-200% FS	
	Current FS	3		200%-300% FS	
Phasor angles		1 degree			

Key:

PT	External potential transformer ratio
CT	Primary current rating of external current transformer
FSV	Voltage full scale
FSI	Current full scale
V _f	Fundamental voltage
I _f	Fundamental current
⊕	@ 80% to 120% of voltage FS and 1% to 200% of current FS

Notes:

1. Accuracy is expressed as ± (percentage of reading + percentage of full scale) ± 1 digit. This does not include inaccuracies introduced by the user's potential and current transformers. Accuracy calculated at 1 second average.
2. Specifications assume: voltage and current waveforms with THD ≤ 5% for kvar, kVA and PF; reference operating temperature: 20°C-26°C.
3. Measurement error is typically less than the maximum error indicated here.

PM180 ORDER STRING

OPTIONS

DISPLAY

Transducer version—no display	X
Graphic color display—5.7" touchscreen	G
Graphic color display - 5.7" touchscreen + DIN rail mounting kit & 3m/10ft remote cable	G-DIN
3 line ultra bright LED display	D
3 line ultra bright LED display, DIN rail mounting kit & 3m/10ft remote cable	D-DIN
Multi window ultra bright LED display with 12 values + 1 text window	M

VOLTAGE INPUTS

690V AC Nominal Voltage Input	-
120V AC Nominal Voltage Input	U

CURRENT INPUTS

50A, calibrated to 5A (Class 0.2S Accuracy)	5
10A, calibrated to 1A (Class 0.2S Accuracy)	1
100A Split Core HACs, Calibrated to 5A (Class 1 Accuracy)	CS1S
100A Split Core Handheld Clamp HACs, Ø13mm opening, 5A (Class 1 Accuracy)	CS1H
Use of any High Accuracy Current Sensors (HACS), without overcurrent.	HACS
Use of 3VAC current clamps (should be purchased locally)	FLEX

FREQUENCY - 50 / 60 HZ

ACCURACY AND POWER QUALITY STANDARD	50Hz/60Hz
-------------------------------------	-----------

ANSI C12.20—USA Standard IEEE1159 Full Power Quality	A
IEC 62053-22—European Standard EN50160 Full Power Quality	E
GOST 13109 / GOST 54149—Russian Standard	G

COMMUNICATION STANDARD

Default: Modbus RTU, Modbus TCP, DNP 3.0, DNP/TCP, IEC 60870-5-101 & -104	-
Default communication plus IEC 61850 (SISCO)	850

TESTING AND CERTIFICATE

Full functional test, calibration at various work loads & detailed test report	-
Full functional test, calibration at various work loads & detailed test report plus ISO 17025 and ILAC certified calibration certificate	CC

OPTIONAL PLUG-IN MODULES

Maximum 3 modules per instrument

OPTIONS

MEASUREMENT / FAULT CHANNELS (MAX. 1 MODULE FROM EACH TYPE)

Transient Recorder Module (4 volt. channels, up to 2kV & 1024 samples per cycle per channel)	TRM
PMU (Phase Monitoring Unit), plus transient module	PMU
Fault Recorder Module (4 current channels, up to 200A), incl. 4 × CS2 / CS2S / CS2SL HACs	DFR-CS2/CS2S/CS2SL

16 DIGITAL INPUTS (MAX. 48 DIGITAL INPUTS)

Dry Contacts (DRC) / 24V DC / 125V DC / 250V DC	DI16 DRC/24V/ 125V/250V
---	----------------------------

8 RELAY OUTPUTS (MAX. 24 RELAY OUTPUTS)

8 DI / 8 RO	RLY8 DI8 RO8
-------------	-----------------

COMMUNICATION

IRIG-B and RS-422/485 port	IRIG
Fiber Optic Ethernet (TXFX), redundant Ethernet & 2 nd RS-422/485 port	TXFX
2G/3G GSM Modem (850/870 protocol not supported) & 2 nd RS-422/485 port	T3G
2G/3G CDMA Modem (850/870 protocol not supported) & 2 nd RS-422/485 port	T3C

4 ANALOG INPUT / 4 ANALOG OUTPUT MODULE (MAX. 12AI/12AO)

± 1mA (x=1) / 0-20 mA (x=2) / 0-1 mA (x=3) / 4-20 mA (x=4)	4AIOx 4AIV
--	---------------

4 ANALOG INPUT (MAX 12AI), ± 10V

AUX. P.S. 85-265V AC and 40-300V DC	BACDC
AUX. P.S. 9.5-36 V DC	B21DC



www.satec-global.com

HEADQUARTERS

SATEC INC.
North & South America
10 Milltown Court
Union, NJ 07083, USA

Tel. 1-888-OK-SATEC
Local 908-686-9510
Fax. 908-686-9520
sales@satec-global.com

SATEC LTD.
Europe & Africa
P.O. Box 45022
Jerusalem 9145001, Israel

Tel. 972-2-541-1000
Fax. 972-2-581-2371
satec@satec-global.com

SATEC CHINA
Asia
No. 25 Ganluyuan Nanli
Beijing, China 100123

Tel. +86-10-8559-0609
Fax. +86-10-8559-0609
china@satec-global.com

SATEC (AUSTRALIA) PTY LTD
Oceania
P.O. Box 82
Mulgoa, NSW 2745, Australia

Tel. 61-2-4774-2959
Fax. 61-2-4774-0249
sales@satec-global.com.au