

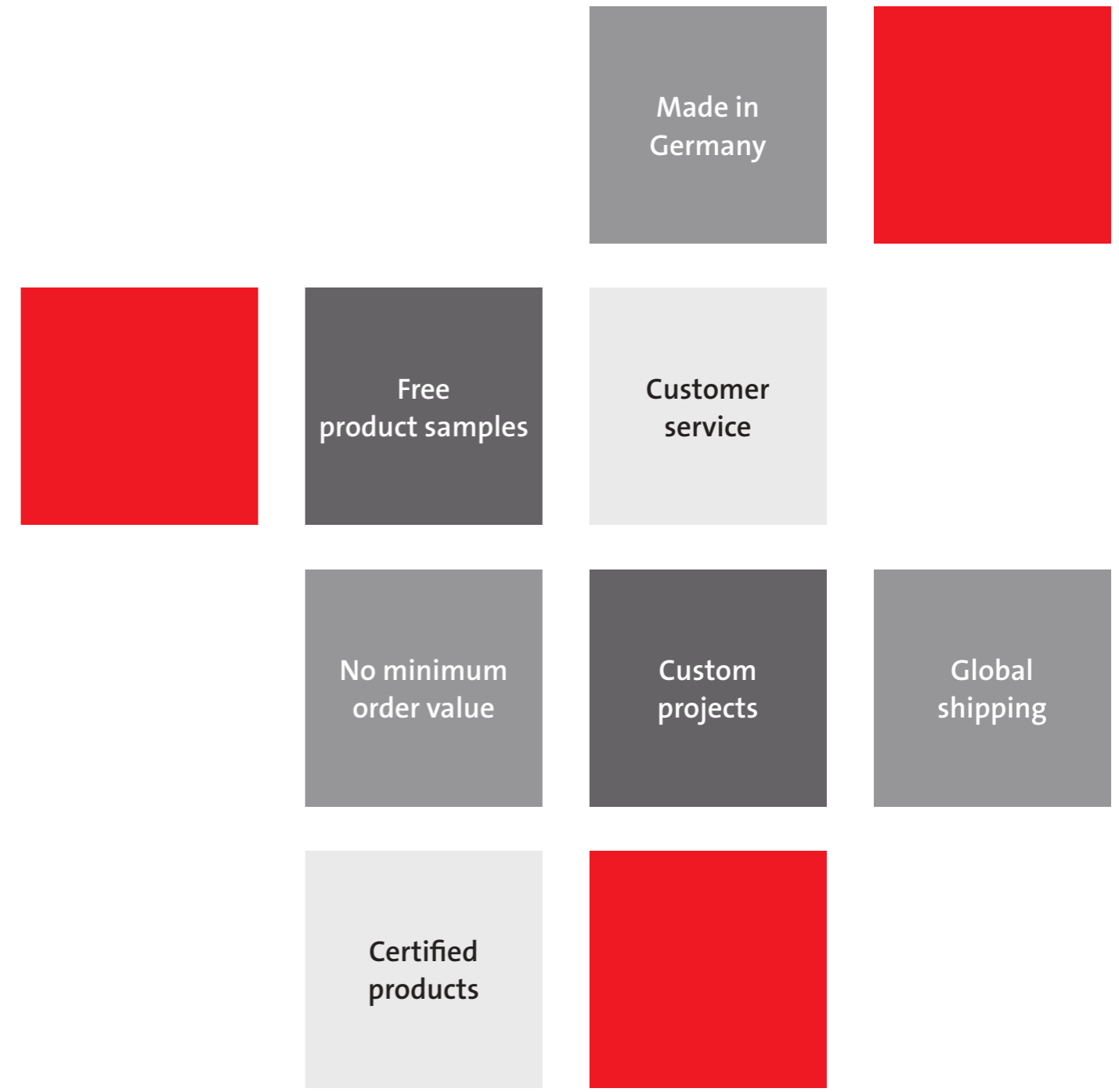

Product catalogue 36

Cable management systems







smart cable management

Ideas move the world – under this motto we have been developing innovative cable management systems since 1995. From our headquarters in Eschach, Germany, we produce our smart cable management solutions and distribute them in more than 60 countries. We are a strong and reliable partner for the industry together with our subsidiaries in Europe, Asia and North America as well as our global representatives. Globally leading companies from various sectors rely on our know-how and our innovative strength. Numerous patents and certifications are both an incentive and aspiration for us.



Having trouble finding a solution?
 icotek can develop a solution for
 your individual needs.
Contact us: pm@icotek.com

Cable entry systems for cables with connectors – **KT system**

1.11 	Split cable entry frames for the KT grommet system 8 – 51	1.12 	Split cable glands for the KT grommet system 52 – 61	1.13 	DB Distribution Box for 360° cable entry for the KT grommet system 62 – 65
1.14 	Cable grommets for the KT system 66 – 81	1.15 	IMAS-CONNECT™ Modular adapter system for the KT system 82 – 91		

Cable entry systems for cables with connectors – **QT system**

1.21 	Split cable entry frames for the QT grommet system 92 – 97	1.22 	Split cable glands for the QT grommet system 98 – 101	1.23 	Split plug-in cable entry plates for the QT grommet system 102 – 105
1.24 	Cable grommets for the QT system 106 – 111	1.25 	IMAS-CONNECT™ Modular adapter system for the QT system 112 – 121		

Cable entry systems for cables without connectors

2.1 	Cable entry plates for cables without connectors 122 – 153	2.2 	Flexible cable entry grommets for cables without connectors 154 – 163
--	--	---	---

Strain relief & cable management

3.1 	Systems for strain relief 164 – 175	3.2 	Systems for cable management 176 – 187
--	---	---	--







EMC solutions

4.1 	EMC cable shield earthing Shield clamps & earthing components 188 – 233	4.2 	Split EMC cable entry frames for earthing conducted and field-bound disturbances 234 – 237, 240 – 245	4.2 	Split EMC cable glands for earthing conducted and field-bound disturbances 238 – 239
--	---	---	---	--	--

CONFIX™ Cable conduit system, cable protection conduits

5.1 	CONFIX™ Cable conduit systems 246 – 249	5.2 	CONFIX™ Cable conduit systems 250 – 251	5.2 	CONFIX™ Cable conduit systems, split 252 – 253
---	---	---	---	---	--

Enclosure accessories

6.1 	Enclosure accessories Gland plates, flange plates & accessories 254 – 275	6.2 	Enclosure accessories Gland plates, flange plates & accessories 276 – 285	6.3 	Enclosure accessories Gland plates, flange plates & accessories 286 – 289
6.4 	Enclosure accessories Gland plates, flange plates & accessories 290 – 295	6.4 	GMT Split locknut 292	6.4 	PCE M12x1,5 Pressure compensation element 295

Cable pass-through with brush seal

7.1 	Cable pass-through with brush seal, brush strips 296 – 299	7.2 	Cable pass-through with brush seal, brush strips 300 – 311	7.3 	Brush strips for the cable management 312 – 313
--	--	--	--	--	---

icotek TOOLS

8 	icotek TOOLS Punch drivers, knockout punches & useful tools 314 – 323
---	---

Fire penetration seals

9 	Cable entry systems with IFPS fire penetration seals acc. to EN 45545-3 324 – 327
---	---



Cleanrooms

10 	Cable entry systems for the use in cleanrooms 328 – 341
--	---

Food industry

11.1 	Split cable entry frames for the food industry for cables with connectors <i>Blue Line</i> 342 – 347	11.1 	Split cable grommets for cable entry frames for the food industry for cables with connectors <i>Blue Line</i> 348 – 349	11.2 	Cable entry plates for the food sector for cables without connectors <i>Hygienic Design Line</i> 350 – 355
--	--	--	---	--	--

ALLIOLIGHT LED luminaires

12 	TUBE Machine luminaire, protection class IP67 356 – 359	12 	ALU-LINE Enclosure luminaire with integrated socket 360 – 361	12 	ALLIO Enclosure luminaire with 190° rotating tube 362 – 365
--	---	--	---	--	---

1 Cable entry systems for cables with connectors



Product group 1 includes all split cable entry systems in round and rectangular versions. Cables with and without preassembled connectors with a maximum diameter of 75 mm can thus be inserted. The split frame and split grommets alleviate the need to cut and re-wire pre-terminated cables. Therefore, cable warranties are unaffected.

By closing the upper and lower part of the frame a high contact pressure on the cable grommets and cables is achieved. In most cases, the cables

are strain relieved according to EN 62444 and immediately sealed with IP54 to IP66/ IP68/UL type 4X (depending on type).

icotek also offers split and non-split brush plates for cable pass-through, based on rectangular and round standard cut-outs – a very cost-effective solution if sealing with IP54 ist not required. See product group 7 on page 296.



All icotek products with a type rating have been tested and certified by UL according to UL 50E! More information about UL Type Rating vs. NEMA Rating in the appendix on page 373.



Configure your custom frames and grommets conveniently online with our Product Configurator on www.icotek.com

Single-piece packaging units are available on request.

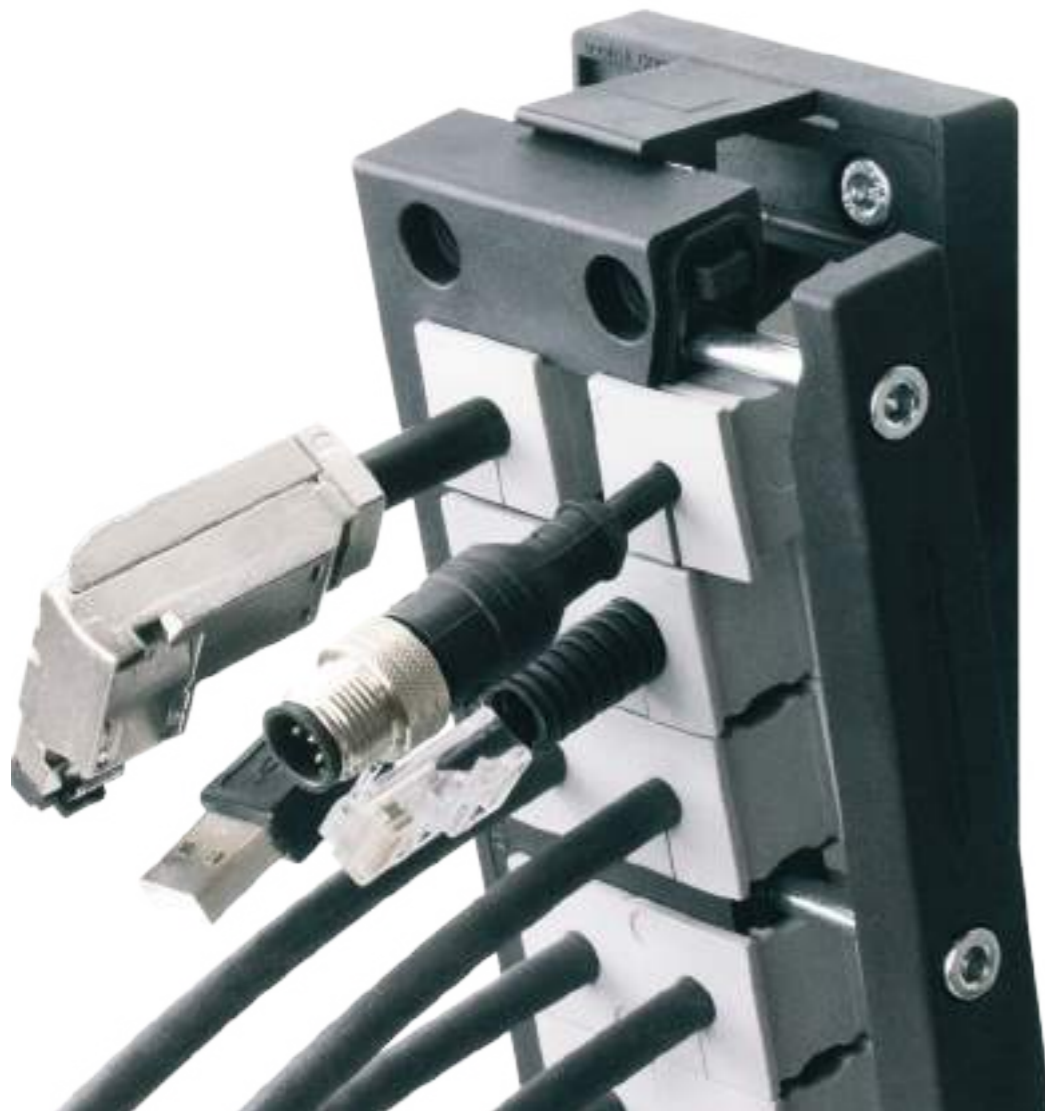

Product	IP54	IP65 IP66	IP67 IP68	UL TYPE 12	UL TYPE 4X*	Strain relief	IMAS-CONNECT compatible	Cable Ø mm min max	Max. no. of cables	Page
KEL-ER	■	■		■	■	■	■	1 – 35	10	10–12
KEL-ER-E	■	■		■		■	■	1 – 16	5	13
KEL-ER CR	■	■		■	■	■	■	1 – 35	10	332
KEL-U	■			■		■	■	1 – 35	40	14–16
KEL-U CR	■			■		■	■	1 – 35	40	333
KEL-E	■			■		■	■	1 – 16	20	17
KEL-FA	■					■	■	1 – 35	40	18–21
KEL	■			■		■	■	1 – 35	40	22–25
KEL 16/24 Extensions	■					■	■	1 – 35	120	26–31
KEL-FG-ER	■	■				■	■	1 – 35	10	36–39
KEL-FG-A/B	■			■		■	■	1 – 35	40	40–42
KEL-FG-E	■			■		■	■	1 – 16	20	43
KEL-FW	■	■				■	■	1 – 35	16	44 – 45
KEL-FL	■					■	■	1 – 16 + flat cables	13	34–35
KEL 183	■			■		■	■	1 – 75	16	32–33
KEL-SNAP(-S)	■							–	–	46 – 49
KEL-JUMBO	■			■		■	■	1 – 65	2	50 – 51
KVT-ER	■	■	■	■	■	■	■	1 – 35	4	54 – 55
KVT	■			■		■	■	1 – 35	16	56–57
KVT-SNAP	■					■	■	1 – 35	16	59
KVT-W90	■					■	■	1 – 35	16	60
KVT 80	■			■		■	■	1 – 35	24	58
DB	■					■	■	1 – 15	48	62 – 65
KEL-QUICK	■			■			■	1 – 29	40	96 – 97
QVT	■						■	1 – 15	16	100
QVT-CLICK	■						■	1 – 29	16	101
KEL-QTA	■							1 – 15	26	104 – 105
KEL-QTE	■							1 – 15	2	105
KEL-BES / KEL-BES-S								max. 33		298–299

*4X for indoor use only | Further details on certifications and technical specifications can be found on the product pages.

1.11 Split cable entry frames for the KT grommet system



The patented cable entry system enables the user to enter, seal and provide strain relief according to EN 62444 for pre-terminated cables and cables without connectors (up to 75 mm in diameter).

Electrical, pneumatic or hydraulic lines as well as corrugated conduits and hoses can be easily routed, sealed and strain relieved using split cable entry systems.

The key feature of the patented system is the split frame and split grommets which provide quick, convenient and cost effective routing of pre-terminated and multi-conductor cables, hoses and conduits. The split frame and split grommets alleviate the need to cut and re-wire pre-terminated cables. Therefore, cable warranties are unaffected.

Cables, pipes and conduits with various diameters can be routed due to a large variety of split grommets. When assembled correctly, the split grommets are held tightly within the frame. Correctly sizing the grommet to the cable diameter ensures a high degree of protection (up to IP66/UL type 4X) and provides strain relief.

- Split system**: Shows the assembly of the split frame and grommet.
- Secure and tight connection**: Shows a close-up of a cable being inserted into the frame.
- Maintain warranty on pre-terminated cables**: Shows a yellow pre-terminated cable being inserted.
- Fast and easy assembly**: Shows a stopwatch icon indicating quick installation.
- Most sizes are industrial standard cut-outs. No need for additional tooling.**: Includes a technical drawing of a rectangular cut-out with dimensions L1, B1, and Ø5.50.
- Integrated strain relief according to EN 62444**: Shows the frame's internal structure.
- High cable density, wide variety in cable grommets and adapter grommets**: Shows various grommet types.
- Can be combined with IMAS-CONNECT grommets**: Shows a grommet with a circular opening.
- KEL-U/KEL: IP54 rated protection**
- KEL-ER: IP66 due to a high clamping pressure on the cover lid and injected sealing**



KEL 24|21-2 MT mounted with AT-M, equipped with M12 pressure compensation element, see page 89.

<p>Split cable entry frames for cable diameters up to 35 mm</p> <p>KEL-ER series 10 – 13</p>	<p>Split cable entry frames for cable diameters up to 35 mm</p> <p>KEL-U series / KEL-E series 14 – 17</p>	<p>Split cable entry frames "Fast Assembly" for a fast assembly without tools for cable diameters up to 35 mm</p> <p>KEL-FA series 18 – 21</p>
<p>Centrally split cable entry frames for cable diameters up to 35 mm</p> <p>KEL series 22 – 25</p>	<p>Extended split cable entry frames for cable diameters up to 35 mm</p> <p>KEL series, extended 26 – 31</p>	<p>Split cable entry frames for cable diameters up to 75 mm</p> <p>KEL 183 series / KTMB 183 32 – 33</p>
<p>Split cable entry frames for flat cables and round cables up to 17 mm in diameter</p> <p>KEL-FL / FT 34 – 35</p>	<p>Split flange enclosure for 90° cable transit with integrated seal for cable diameters up to 35 mm</p> <p>KEL-FG-ER series 36 – 39</p>	<p>Split flange enclosure for 90° cable transit for cable diameters up to 35 mm</p> <p>KEL-FG series 40 – 43</p>
<p>Bulkhead for 90° cable transit for cable diameters up to 35 mm</p> <p>KEL-FW 44 – 45</p>	<p>Snap mounting frames for installation of KEL-U / KEL frames, split (KEL-SNAP-S)</p> <p>KEL-SNAP-S / KEL-SNAP 46 – 49</p>	<p>Split cable entry frames for cable diameters up to 65 mm</p> <p>KEL-JUMBO / KTF 50 – 51</p>
<p>360° cable entry for cable diameters up to 15 mm</p> <p>DB 62 – 65</p>	<p>Cable grommets split and not split, for cables with/without connectors, for cable diameters 1 – 35 mm</p> <p>66 – 81</p>	<p>IMAS-CONNECT™ Modular adapter system for the KT system</p> <p>Adapter grommets /Accessories 82 – 91</p>

Cable entry frames with IP66 rating KEL-ER series

KEL-ER Cable entry frames KEL-ER 24, KEL-ER 16

Split cable entry system for routing and sealing cables with connectors, providing an IP66/UL Type 12/4X rating and strain relief for cable diameters from 1 to 17 mm (single-hole grommets KT1 to KT17) and 16 to 35 mm (single-hole grommets KT16 to KT34).

The cable entry system is easy to install. Cable grommets are placed into compartments and are securely fixed to the frame during assembly.

The KEL-ER frames match exactly the cut-out dimensions for 10-, 16- and 24-pin standard industrial connectors. Either a cut-out of 36 mm or 46 mm in height can be chosen depending on the cables being routed. The KEL-ER-B frame matches the cut-out dimensions of 46 x 46 mm measuring instruments.

The single-row versions KEL-ER-E are particularly suited for flat connectors. The small frames are ideal for applications with limited space. A flat rubber gasket is included in the shipment.

The version with threaded bushings enables the cable entry frame to be screwed onto the housing from the inside out. This protects against vandalism and tampering with the housing from the outside.

Advantages & benefits

- Maintain manufacturer's warranty on pre-terminated cables
- Retrofittings, repairs and maintenance can be done much more easily and quickly
- High cable density, wide variety of grommets
- Strain relief according to EN 62444
- High stability, vibration resistant
- Can be combined with IMAS-CONNECT adapter grommets

Specifications

Material	Polyamide (PA)
Flame class	UL 94 V-0, self-extinguishing
IP rating	IP66, with gasket and correct selection of single grommets (certified acc. to EN 60529)
UL type rating	UL type 4X (acc. to UL 50E)
Temperature	-40°C to +140°C (static)
Properties	Halogen-free, silicone-free
Frame depth	17 mm

Accessories

KT Cable grommets	66 – 81
AT Adapter grommets	82 – 91
KEL-EMC Cable collectors	224 – 226
ST Plugs	77



Also available with stainless steel screws (V2A)

Also available with threaded bushings



The cable entry frames enable the integration of the IMAS-CONNECT™ adapter grommets



Split KT grommets

i The KEL-ER series is also available as a cleanroom version, see from page 332. Single-piece packaging units are available on request.

*4X for indoor use only



Description	Cut-out Drilling template	Type	Cut-out mm	Grommets small large	Order No.	PU
		KEL-ER 24 10	36/46 x 112	10 -	48241	10
		KEL-ER 24 10 with V2A screws	36/46 x 112	10 -	48241.200	10
		KEL-ER 24 10 with threaded bushings M4	36/46 x 112	10 -	48241.400	10
		KEL-ER 24 7	36/46 x 112	6 1	48247	10
		KEL-ER 24 7 with V2A screws	36/46 x 112	6 1	48247.200	10
		KEL-ER 24 7 with threaded bushings M4	36/46 x 112	6 1	48247.400	10
		KEL-ER 24 4	36/46 x 112	2 2	48244	10
		KEL-ER 24 4 with V2A screws	36/46 x 112	2 2	48244.200	10
		KEL-ER 24 4 with threaded bushings M4	36/46 x 112	2 2	48244.400	10
		KEL-ER 16 8	36/46 x 86	8 -	48168	10
		KEL-ER 16 8 with V2A screws	36/46 x 86	8 -	48168.200	10
		KEL-ER 16 8 with threaded bushings M4	36/46 x 86	8 -	48168.400	10
		KEL-ER 16 5	36/46 x 86	4 1	48165	10
		KEL-ER 16 5 with V2A screws	36/46 x 86	4 1	48165.200	10
		KEL-ER 16 5 with threaded bushings M4	36/46 x 86	4 1	48165.400	10
		KEL-ER 16 2	36/46 x 86	- 2	48162	10
		KEL-ER 16 2 with V2A screws	36/46 x 86	- 2	48162.200	10
		KEL-ER 16 2 with threaded bushings M4	36/46 x 86	- 2	48162.400	10

*4X for indoor use only

KEL-ER
Cable entry frames
KEL-ER 10, KEL-ER B

IP66



Description	Cut-out Drilling template	Type	Cut-out mm	Grommets small large	Order No.	PU
		KEL-ER 10 6	36/46 x 65	6 -	48216	10
		KEL-ER 10 6 with V2A screws	36/46 x 65	6 -	48216.200	10
		KEL-ER 10 6 with threaded bushings M4	36/46 x 65	6 -	48216.400	10
		KEL-ER 10 3	36/46 x 65	2 1	48212	10
		KEL-ER 10 3 with V2A screws	36/46 x 65	2 1	48212.200	10
		KEL-ER 10 3 with threaded bushings M4	36/46 x 65	2 1	48212.400	10
		KEL-ER-B4	46 x 46	4 -	48204	10
		KEL-ER-B4 with V2A screws	46 x 46	4 -	48204.200	10
		KEL-ER-B4 with threaded bushings M4	46 x 46	4 -	48204.400	10
		KEL-ER-B1	46 x 46	- 1	48206	10
		KEL-ER-B1 with V2A screws	46 x 46	- 1	48206.200	10
		KEL-ER-B1 with threaded bushings M4	46 x 46	- 1	48206.400	10

i The KEL-ER series is also available as a cleanroom version, see from page 332. Single-piece packaging units are available on request.

KEL-ER
Cable entry frames
KEL-ER-E

IP66



Description	Cut-out Drilling template	Type	Cut-out mm	Grommets small large	Order No.	PU
		KEL-ER-E5	112 x 24	5 -	48250	10
		KEL-ER-E5 with V2A screws	112 x 24	5 -	48250.200	10
		KEL-ER-E5 with threaded bushings M4	112 x 24	5 -	48250.400	10
		KEL-ER-E4	112 x 24	4 -	48259	10
		KEL-ER-E4 with V2A screws	112 x 24	4 -	48259.200	10
		KEL-ER-E4 with threaded bushings M4	112 x 24	4 -	48259.400	10
		KEL-ER-E3	65 x 24	3 -	48258	10
		KEL-ER-E3 with V2A screws	65 x 24	3 -	48258.200	10
		KEL-ER-E3 with threaded bushings M4	65 x 24	3 -	48258.400	10
		KEL-ER-E2	43 x 24	2 -	48249	10
		KEL-ER-E2 with V2A screws	43 x 24	2 -	48249.200	10
		KEL-ER-E2 with threaded bushings M4	43 x 24	2 -	48249.400	10

i The KEL-ER series is also available as a cleanroom version, see from page 332. Single-piece packaging units are available on request.

Cable entry frames with IP54 rating
KEL-U series

KEL-U
Cable entry frames
KEL-U 24, KEL-U 16

Split cable entry system for routing cables with connectors providing an IP54/UL Type 12 rating. Routing, sealing and providing strain relief for cable diameters from 1 to 35 mm.

The cable entry system is easy to install. Cable grommets are placed into compartments and are securely fixed to the frame during assembly.

The KEL-U frames match exactly the cut-out dimensions for 10-, 16- and 24-pin standard industrial connectors. Either a cut-out of 36 mm or 46 mm in height can be chosen depending on the cables being routed. The KEL-U-B frame matches the cut-out dimensions of 46 x 46 mm measuring instruments. For tool-free assembly/disassembly of the cable entry frames the snap mounting frame KEL-SNAP can be used.

The single-row versions KEL-E are particularly suited for flat connectors. The small frames are ideal for applications with limited space. A flat rubber gasket is included in the shipment.

The version with threaded bushings enables the cable entry frame to be screwed onto the housing from the inside out. This protects against vandalism and tampering with the housing from the outside.

Advantages & benefits

- Fast and easy assembly
- Maintain manufacturer's warranty on pre-terminated cables
- Retrofittings, repairs and maintenance can be done much more easily and quickly
- High cable density, wide variety of grommets
- Strain relief according to EN 62444
- High stability, vibration resistant
- Can be combined with IMAS-CONNECT adapter grommets

Specifications

Material	Polyamide (PA)
Flame class	UL 94 V-0, self-extinguishing
IP rating	IP54, with gasket and correct selection of cable grommets (certified acc. to EN 60529)
UL type rating	UL type 12 (acc. to UL 50E)
Temperature	-40°C to +140°C (static)
Properties	Halogen-free, silicone-free
Frame depth	17 mm

Accessories

KT Cable grommets	66 - 81
AT Adapter grommets	82 - 91
KEL-SNAP Mounting frames	46 - 49
KEL-EMC Cable collectors	224 - 226
KDR Base plates	258 - 275
FP Flange plates	276 - 285
ST Plugs	77

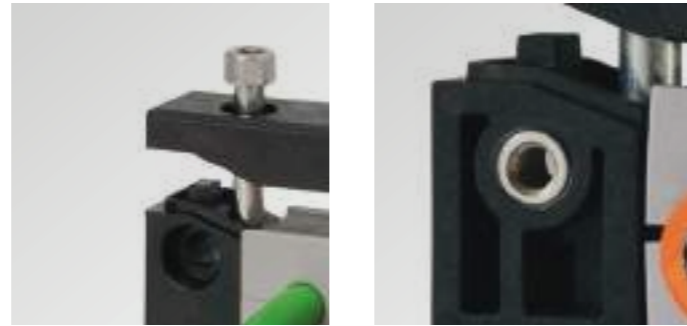

Also available with stainless steel screws (V2A)

Also available with threaded bushings



The cable entry frames enable the integration of the IMAS-CONNECT™ adapter grommets



Split KT grommets

i The KEL-U series is also available as a cleanroom version, see from page 333. Single-piece packaging units are available on request.



Description	Cut-out Drilling template	Type	Cut-out dimensions mm	Grommets small large	Order No.	PU
		KEL-U 24 10	36/46 x 112	10 -	54241	10
		KEL-U 24 10 with V2A screws	36/46 x 112	10 -	54241.200	10
		KEL-U 24 10 with threaded bushings M4	36/46 x 112	10 -	54241.400	10
		KEL-U 24 7	36/46 x 112	6 1	54247	10
		KEL-U 24 7 with V2A screws	36/46 x 112	6 1	54247.200	10
		KEL-U 24 7 with threaded bushings M4	36/46 x 112	6 1	54247.400	10
		KEL-U 24 4	36/46 x 112	2 2	54244	10
		KEL-U 24 4 with V2A screws	36/46 x 112	2 2	54244.200	10
		KEL-U 24 4 with threaded bushings M4	36/46 x 112	2 2	54244.400	10
		KEL-U 16 8	36/46 x 86	8 -	54168	10
		KEL-U 16 8 with V2A screws	36/46 x 86	8 -	54168.200	10
		KEL-U 16 8 with threaded bushings M4	36/46 x 86	8 -	54168.400	10
		KEL-U 16 5	36/46 x 86	4 1	54165	10
		KEL-U 16 5 with V2A screws	36/46 x 86	4 1	54165.200	10
		KEL-U 16 5 with threaded bushings M4	36/46 x 86	4 1	54165.400	10
		KEL-U 16 2	36/46 x 86	- 2	54162	10
		KEL-U 16 2 with V2A screws	36/46 x 86	- 2	54162.200	10
		KEL-U 16 2 with threaded bushings M4	36/46 x 86	- 2	54162.400	10

1.11
KEL-U
Cable entry frames
KEL-U 10, KEL-U-B



Description	Cut-out Drilling template	Type	Cut-out dimensions mm	Grommets small large	Order No.	PU
		KEL-U 10 6	36/46 × 65	6 -	54216	10
		KEL-U 10 6 with V2A screws	36/46 × 65	6 -	54216.200	10
		KEL-U 10 6 with threaded bushings M4	36/46 × 65	6 -	54216.400	10
		KEL-U 10 3	36/46 × 65	2 1	54212	10
		KEL-U 10 3 with V2A screws	36/46 × 65	2 1	54212.200	10
		KEL-U 10 3 with threaded bushings M4	36/46 × 65	2 1	54212.400	10
		KEL-U-B4	46 × 46	4 -	54204	10
		KEL-U-B4 with V2A screws	46 × 46	4 -	54204.200	10
		KEL-U-B4 with threaded bushings M4	46 × 46	4 -	54204.400	10
		KEL-U-B1	46 × 46	- 1	54206	10
		KEL-U-B1 with V2A screws	46 × 46	- 1	54206.200	10
		KEL-U-B1 with threaded bushings M4	46 × 46	- 1	54206.400	10

i The KEL-U series is also available as a cleanroom version, see from page 333. Single-piece packaging units are available on request.

1.11
KEL-E
Cable entry frames



Description	Cut-out Drilling template	Type	Cut-out dimensions mm	Grommets small large	Order No.	PU
		KEL-E5	112 × 24	5 -	42250	10
		KEL-E5 with V2A screws	112 × 24	5 -	42250.200	10
		KEL-E5 with threaded bushings M4	112 × 24	5 -	42250.400	10
		KEL-E4	86 × 24	4 -	42259	10
		KEL-E4 with V2A screws	86 × 24	4 -	42259.200	10
		KEL-E4 with threaded bushings M4	86 × 24	4 -	42259.400	10
		KEL-E3	65 × 24	3 -	42258	10
		KEL-E3 with V2A screws	65 × 24	3 -	42258.200	10
		KEL-E3 with threaded bushings M4	65 × 24	3 -	42258.400	10
		KEL-E2	43 × 24	2 -	42249	10
		KEL-E2 with V2A screws	43 × 24	2 -	42249.200	10
		KEL-E2 with threaded bushings M4	43 × 24	2 -	42249.400	10
		NEW KEL-E1	21 × 27	1 -	42261	10
		NEW KEL-E1 with V2A screws	21 × 27	1 -	42261.200	10

1.11 Cable entry frames “Fast Assembly” for a fast assembly without tools **KEL-FA series**

The KEL-FA series (“Fast Assembly”) is a compact system for routing and sealing cables with and without connectors, as well as hoses and pneumatic cables.

After the frame has been equipped with the KT grommet system, the cover is put on and the two clamping levers are locked with the lower part by pressing them down. The twist-proof construction of the KEL-FA enables an intuitive assembly. The split cable entry allows for the routing of cables with a diameter of 1 mm to 35 mm, providing an IP54 rating.

The KEL-FA frames match exactly the cut-out dimensions for 10-, 16- and 24-pin standard industrial connectors. Either a cut-out of 36 mm or 46 mm in height can be chosen depending on the cables and connectors being routed.

The KEL-FA frames can either be screw mounted or simply snapped into the KEL-SNAP frame.

Advantages & benefits

- Fast assembly without tools
- Warranty on pre-terminated cables remains
- Retrofittings, repairs and maintenance can be done much more quickly
- Very high cable density with multi-hole grommets
- High flexibility with multi-range grommets and the IMAS-CONNECT™ system
- Strain relief according to EN 62444 (with single KT grommets)
- Integrated sealing

Specifications

Material	Polyamide (PA)
Flame class	UL 94 V-0, self-extinguishing
IP rating	IP54, with gasket and correct selection of cable grommets (certified acc. to EN 60529:2014-09)
Temperature	-40°C to +140°C (static)
Properties	UV-resistant, silicone-free, anti-corrosive, halogen-free
Frame depth	22 mm

Accessories

KT Cable grommets	66 - 81
AT Adapter grommets	82 - 91
KEL-SNAP Mounting frames	46 - 49
ST Plugs	77

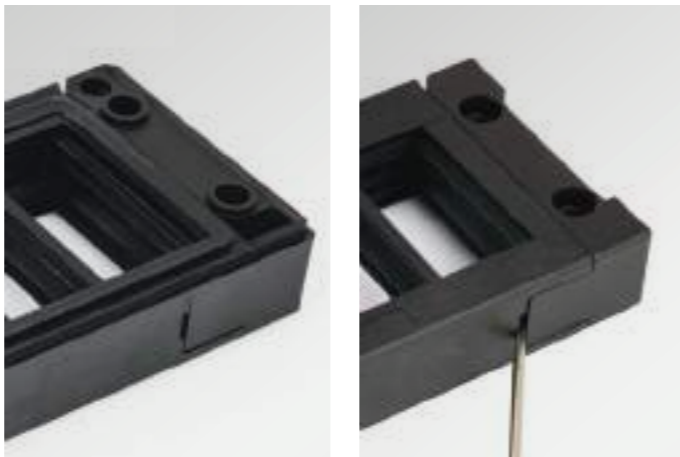

Integrated sealing



Particularly easy assembly with the KEL-SNAP mounting frame

1.11 **KEL-FA** Cable entry frames “Fast Assembly” **KEL-FA 24**



Description	Cut-out Drilling template	Type	Cut-out dimensions mm	Grommets small large	Order No.	PU
		KEL-FA 24 10	36/46 × 112	10 -	55241	10
		KEL-FA 24 7	36/46 × 112	6 1	55247	10
		KEL-FA 24 4	36/46 × 112	2 2	55244	10



i Single-piece packaging units are available on request.

KEL-FA
 Cable entry frames
 “Fast Assembly”
 KEL-FA 16

IP54

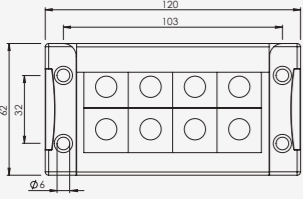
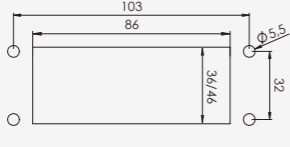
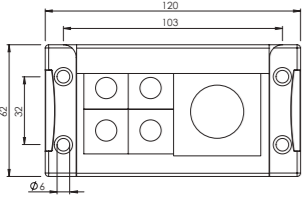
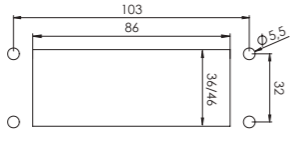
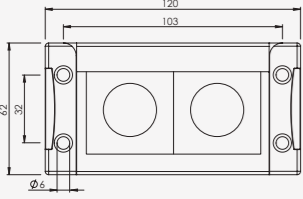
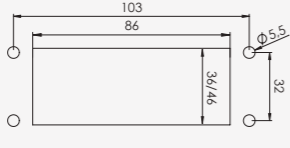

Description	Cut-out Drilling template	Type	Cut-out dimensions mm	Grommets small large	Order No.	PU
		KEL-FA 16 8	36/46 x 86	8 -	55168	10
		KEL-FA 16 5	36/46 x 86	4 1	55165	10
		KEL-FA 16 2	36/46 x 86	- 2	55162	10



 Single-piece packaging units are available on request.

KEL-FA
 Cable entry frames
 “Fast Assembly”
 KEL-FA 10

IP54

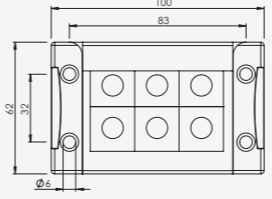
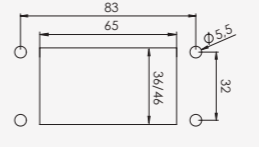
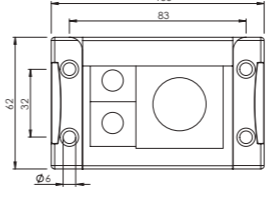
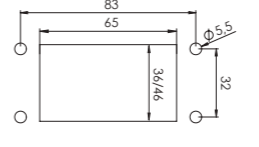

Description	Cut-out Drilling template	Type	Cut-out dimensions mm	Grommets small large	Order No.	PU
		KEL-FA 10 6	36/46 x 65	6 -	55216	10
		KEL-FA 10 3	36/46 x 65	2 1	55212	10



 Single-piece packaging units are available on request.

Cable entry frames
with IP54 rating
KEL series

KEL
Cable entry frames
KEL 24

The classic KEL is a centrally split cable entry system for routing cables with connectors, providing an IP54/up to UL Type 12 rating.

The split KT grommet matching the cable diameter is placed around the cable and inserted into the cable entry frame. The split cable entry frames KEL match exactly the cut-out dimensions of 10-, 16- and 24-pin standard industrial connectors. Either a cut-out of 36 mm or 46 mm in height can be chosen depending on the cables being routed. The size KEL-B matches the cut-out dimensions of 46 × 46 mm measuring instruments.

Based on the frame sizes KEL 16 and KEL 24, there are also extended versions with additional middle frames available. Thus allowing a quick, easy and cost effective routing solution for up to 120 cables or hoses.

For tool-free assembly/disassembly of the cable entry frames the snap mounting frame KEL-SNAP can be used. All frame systems come with a rubber gasket.

The version with threaded bushings enables the cable entry frame to be screwed onto the housing from the inside out. This protects against vandalism and tampering with the housing from the outside.

Advantages & benefits

- Maintain manufacturer's warranty on pre-terminated cables
- Retrofittings, repairs and maintenance can be done more easily and quickly
- High cable density, wide variety of grommets
- Strain relief according to EN 62444
- High stability, vibration resistant
- Can be combined with IMAS-CONNECT adapter grommets

Specifications

Material	Polyamide (PA)
Flame class	UL 94 V-0, self-extinguishing
IP rating	IP54, with gasket and correct selection of cable grommets (certified acc. to EN 60529)
UL type rating	UL type 12 (acc. to UL 50E)
Temperature	-40°C to +140°C (static)
Properties	Halogen-free, silicone-free
Frame depth	17 mm

Accessories

KT Cable grommets	66 - 81
AT Adapter grommets	82 - 91
KEL-SNAP Mounting frames	46 - 49
KEL-EMC Cable collectors	224 - 226
KDR Base plates	258 - 275
FP Flange plates	276 - 285
MP Module plates	270 - 271
ST Plugs	77



Also available with stainless steel screws (V2A)

Also available with threaded bushings



The cable entry frames enable the integration of the IMAS-CONNECT™ adapter grommets



Split KT grommets

Can be combined with IMAS-CONNECT adapter grommets



Description	Cut-out Drilling template	Type	Cut-out dimensions mm	Grommets small large	Order No.	PU
		KEL 24 10	36/46 × 112	10 -	42241	10
		KEL 24 10 with V2A screws	36/46 × 112	10 -	42241.200	10
		KEL 24 10 with threaded bushings M4	36/46 × 112	10 -	42241.400	10
		KEL 24 7	36/46 × 112	6 1	42247	10
		KEL 24 7 with V2A screws	36/46 × 112	6 1	42247.200	10
		KEL 24 7 with threaded bushings M4	36/46 × 112	6 1	42247.400	10
		KEL 24 5	36/46 × 112	5 -	42248	10
		KEL 24 5 with V2A screws	36/46 × 112	5 -	42248.200	10
		KEL 24 5 with threaded bushings M4	36/46 × 112	5 -	42248.400	10
		KEL 24 4	36/46 × 86	2 2	42244	10
		KEL 24 4 with V2A screws	36/46 × 86	2 2	42244.200	10
		KEL 24 4 with threaded bushings M4	36/46 × 86	2 2	42244.400	10

KEL
Cable entry frames
KEL 16



Description	Cut-out Drilling template	Type	Cut-out dimensions mm	Grommets small large	Order No.	PU
		KEL 16 8	36/46 × 86	8 -	42168	10
		KEL 16 8 with V2A screws	36/46 × 86	8 -	42168.200	10
		KEL 16 8 with threaded bushings M4	36/46 × 86	8 -	42168.400	10
		KEL 16 5	36/46 × 86	4 1	42165	10
		KEL 16 5 with V2A screws	36/46 × 86	4 1	42165.200	10
		KEL 16 5 with threaded bushings M4	36/46 × 86	4 1	42165.400	10
		KEL 16 4	36/46 × 86	4 -	42164	10
		KEL 16 4 with V2A screws	36/46 × 86	4 -	42164.200	10
		KEL 16 4 with threaded bushings M4	36/46 × 86	4 -	42164.400	10
		KEL 16 2	36/46 × 86	- 2	42162	10
		KEL 16 2 with V2A screws	36/46 × 86	- 2	42162.200	10
		KEL 16 2 with threaded bushings M4	36/46 × 86	- 2	42162.400	10

KEL
Cable entry frames
KEL 10, KEL-B



Description	Cut-out Drilling template	Type	Cut-out dimensions mm	Grommets small large	Order No.	PU
		KEL 10 6	36/46 × 65	6 -	42216	10
		KEL 10 6 with V2A screws	36/46 × 65	6 -	42216.200	10
		KEL 10 6 with threaded bushings M4	36/46 × 65	6 -	42216.400	10
		KEL 10 3	36/46 × 65	2 1	42212	10
		KEL 10 3 with V2A screws	36/46 × 65	2 1	42212.200	10
		KEL 10 3 with threaded bushings M4	36/46 × 65	2 1	42212.400	10
		KEL-B4	46 × 46	4 -	42204	10
		KEL-B4 with V2A screws	46 × 46	4 -	42204.200	10
		KEL-B4 with threaded bushings M4	46 × 46	4 -	42204.400	10
		KEL-B1	46 × 46	- 1	42206	10
		KEL-B1 with V2A screws	46 × 46	- 1	42206.200	10
		KEL-B1 with threaded bushings M4	46 × 46	- 1	42206.400	10

Cable entry frames, extended with IP54 rating
KEL series

KEL
Cable entry frames
KEL-24-E

Based on the frame sizes KEL 16 and KEL 24, there are also extended versions with additional middle frames available. Thus allowing a quick, easy and cost effective routing solution for up to 120 cables or hoses.

A flat rubber gasket is included in the shipment.

The version with threaded bushings enables the cable entry frame to be screwed onto the housing from the inside out. This protects against vandalism and tampering with the housing from the outside.

Advantages & benefits

- Maintain manufacturer's warranty on pre-terminated cables
- Retrofits, repairs and maintenance can be done much more easily and quickly
- High cable density
- Strain relief according to EN 62444
- High stability, vibration resistant
- Can be combined with IMAS-CONNECT adapter grommets
- Great variability in the cable grommets

Specifications

Material	Polyamide (PA)
Flame class	UL 94 V-0, self-extinguishing
IP rating	IP54, with gasket and correct selection of cable grommets (certified acc. to EN 60529)
UL type rating	UL type 12 (acc. to UL 50E)
Temperature	-40°C to +140°C (static)
Properties	Halogen-free, silicone-free
Frame depth	17 mm

Accessories

KT Cable grommets	66 - 81
AT Adapter grommets	82 - 91
KEL-SNAP Mounting frames	46 - 49
KEL-EMC Cable collectors	224 - 226
ST Plugs	77



Also available with stainless steel screws (V2A)



Also available with threaded bushings



The cable entry frames enable the integration of the IMAS-CONNECT™ adapter grommets



Split KT grommets



Description	Cut-out Drilling template	Type	Cut-out dimensions mm	Grommets small large	Order No.	PU
		KEL 24 15-E	66 x 112	15 -	42209	1
		KEL 24 15-E with V2A screws	66 x 112	15 -	42209.200	1
		KEL 24 15-E with threaded bushings M4	66 x 112	15 -	42209.400	1
		KEL 24 12-E	66 x 112	11 1	42208	1
		KEL 24 12-E with V2A screws	66 x 112	11 1	42208.200	1
		KEL 24 12-E with threaded bushings M4	66 x 112	11 1	42208.400	1
		KEL 24 9-E	66 x 112	7 2	42207	1
		KEL 24 9-E with V2A screws	66 x 112	7 2	42207.200	1
		KEL 24 9-E with threaded bushings M4	66 x 112	7 2	42207.400	1
		KEL 24 10-E	66 x 112	10 -	49056	1
		KEL 24 10-E with V2A screws	66 x 112	10 -	49056.200	1
		KEL 24 10-E with threaded bushings M4	66 x 112	10 -	49056.400	1

KEL
Cable entry frames
KEL-24-MT



Description	Cut-out Drilling template	Type	Cut-out dimensions mm	Grommets small large	Order No.	PU
		KEL 24 20-MT	82 x 112	20 -	42232	1
		KEL 24 20-MT with V2A screws	82 x 112	20 -	42232.200	1
		KEL 24 20-MT with threaded bushings M4	82 x 112	20 -	42232.400	1
		KEL 24 17-MT	82 x 112	16 1	42224	1
		KEL 24 17-MT with V2A screws	82 x 112	16 1	42224.200	1
		KEL 24 17-MT with threaded bushings M4	82 x 112	16 1	42224.400	1
		KEL 24 14-MT	82 x 112	12 2	42225	1
		KEL 24 14-MT with V2A screws	82 x 112	12 2	42225.200	1
		KEL 24 14-MT with threaded bushings M4	82 x 112	12 2	42225.400	1
		KEL 24 11-MT	82 x 112	8 3	42222	1
		KEL 24 11-MT with V2A screws	82 x 112	8 3	42222.200	1
		KEL 24 11-MT with threaded bushings M4	82 x 112	8 3	42222.400	1
		KEL 24 8-MT	82 x 112	4 4	42221	1
		KEL 24 8-MT with V2A screws	82 x 112	4 4	42221.200	1
		KEL 24 8-MT with threaded bushings M4	82 x 112	4 4	42221.400	1

KEL
Cable entry frames
KEL-24-2MT

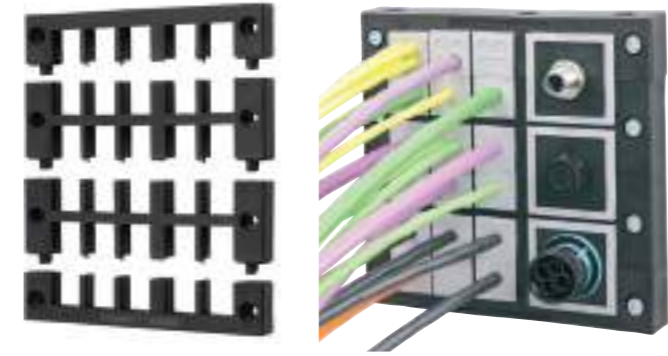

Description	Cut-out Drilling template	Type	Cut-out dimensions mm	Grommets small large	Order No.	PU
		KEL 24 30-2MT	126 x 112	30 -	42234	1
		KEL 24 30-2MT with V2A screws	126 x 112	30 -	42234.200	1
		KEL 24 30-2MT with threaded bushings M4	126 x 112	30 -	42234.400	1
		KEL 24 27-2MT	126 x 112	26 1	42233	1
		KEL 24 27-2MT with V2A screws	126 x 112	26 1	42233.200	1
		KEL 24 27-2MT with threaded bushings M4	126 x 112	26 1	42233.400	1
		KEL 24 24-2MT	126 x 112	22 2	42227	1
		KEL 24 24-2MT with V2A screws	126 x 112	22 2	42227.200	1
		KEL 24 24-2MT with threaded bushings M4	126 x 112	22 2	42227.400	1
		KEL 24 21-2MT	126 x 112	18 3	42226	1
		KEL 24 21-2MT with V2A screws	126 x 112	18 3	42226.200	1
		KEL 24 21-2MT with threaded bushings M4	126 x 112	18 3	42226.400	1
		KEL 24 12-2MT	126 x 112	6 6	42223	1
		KEL 24 12-2MT with V2A screws	126 x 112	6 6	42223.200	1
		KEL 24 12-2MT with threaded bushings M4	126 x 112	6 6	42223.400	1

1.11
KEL
Cable entry frames
KEL 16-E, KEL 16-MT



Description	Cut-out Drilling template	Type	Cut-out dimensions mm	Grommets small large	Order No.	PU
		KEL 16 12-E	66 x 86	12 -	42141	1
		KEL 16 12-E with V2A screws	66 x 86	12 -	42141.200	1
		KEL 16 12-E with threaded bushings M4	66 x 86	12 -	42141.400	1
		KEL 16 6-E	66 x 86	4 2	42140	1
		KEL 16 6-E with V2A screws	66 x 86	4 2	42140.200	1
		KEL 16 6-E with threaded bushings M4	66 x 86	4 2	42140.400	1
		KEL 16 16-MT	82 x 86	16 -	42145	1
		KEL 16 16-MT with V2A screws	82 x 86	16 -	42145.200	1
		KEL 16 16-MT with threaded bushings M4	82 x 86	16 -	42145.400	1
		KEL 16 10-MT	82 x 86	8 2	42144	1
		KEL 16 10-MT with V2A screws	82 x 86	8 2	42144.200	1
		KEL 16 10-MT with threaded bushings M4	82 x 86	8 2	42144.400	1
		KEL 16 4-MT	82 x 86	- 4	42143	1
		KEL 16 4-MT with V2A screws	82 x 86	- 4	42143.200	1
		KEL 16 4-MT with threaded bushings M4	82 x 86	- 4	42143.400	1

1.11
KEL
Cable entry frames
KEL 16-2MT



Description	Cut-out Drilling template	Type	Cut-out dimensions mm	Grommets small large	Order No.	PU
		KEL 16 24-2MT	126 x 86	24 -	42149	1
		KEL 16 24-2MT with V2A screws	126 x 86	24 -	42149.200	1
		KEL 16 24-2MT with threaded bushings M4	126 x 86	24 -	42149.400	1
		KEL 16 12-2MT	126 x 86	8 4	42148	1
		KEL 16 12-2MT with V2A screws	126 x 86	8 4	42148.200	1
		KEL 16 12-2MT with threaded bushings M4	126 x 86	8 4	42148.400	1
		KEL 16 6-2MT	126 x 86	- 6	42147	1
		KEL 16 6-2MT with V2A screws	126 x 86	- 6	42147.200	1
		KEL 16 6-2MT with threaded bushings M4	126 x 86	- 6	42147.400	1

KEL 183
Cable entry frames
for supply cables
KEL 183, KEL 183-E



Description	Cut-out Drilling template	Type	Cut-out mm	Grommets KT KT 183 KT large	Order No.	PU
		KEL 183 2	180 x 80 mm	2 -	47200	1
		KEL 183 2 with V2A screws	180 x 80 mm	2 -	47200.200	1
		KEL 183 5	180 x 80 mm	1 4	47220	1
		KEL 183 5 with V2A screws	180 x 80 mm	1 4	47220.200	1
		KEL 183 8	180 x 80 mm	- 8	47240	1
		KEL 183 8 with V2A screws	180 x 80 mm	- 8	47240.200	1
		KEL 183-E4	180 x 42 mm	- 4	47250	1
		KEL 183-E4 with V2A screws	180 x 42 mm	- 4	47250.200	1
		KEL 183-E16	180 x 42 mm	16 KT small	47255	1
		KEL 183-E16 with V2A screws	180 x 42 mm	16 KT small	47255.200	1

KTMB 183
Grommets for KEL 183



Type	Order No.	Clamping range	PU	
	KTMB-O	41410	Blank grommet	1
	KTMB-P	41415	34 - 44 mm	1
	KTMB-Q	41420	44 - 54 mm	1
	KTMB-R	41425	54 - 64 mm	1
	KTMB-S	41430	64 - 75 mm	1

The split cable entry frame KEL 183 enables the user to route cables and tubes with a diameter of up to 75 mm (depending on the frame type) and to seal them in accordance with IP54/up to UL type 12. For cables up to 35 mm the cable grommets KT can be used. With these split cable grommets, pre-terminated cables can be routed.

For cables up to 75 mm we have created the grommets KTMB for KEL 183. Those are not split and have a defined area for pushing the cable through.

The blank grommet KTMB-O can accept cable sizes within a specified range. The membrane of the KTMB-O can be pierced or cut (cable diameter minus 10 mm) for cables up to 55 mm in diameter.

All frame systems come with a rubber gasket.

Advantages & benefits

- Installation of cables up to 75 mm
- Grommets allow rigid cables to be properly positioned and oriented during the installation process
- Retrofittings, repairs and maintenance can be done much more easily and quickly
- Can be combined with IMAS-CONNECT adapter grommets
- Great variability in the cable grommets

Specifications

Material	KEL 183: Polyamide (PA) KTMB: Elastomere
Flame class	UL 94 V-0, self-extinguishing
IP rating	IP54 with gasket and correct selection of the cables (certified acc. to EN 60529)
UL type rating	UL type 12 (acc. to UL 50E)
Temperature	KEL 183: -40°C to +140°C (static) KTMB: -40°C to +100°C (static)
Properties	Halogen-free, silicone-free
Frame depth	17 mm

Accessories

KT Cable grommets	66 - 81
AT Adapter grommets	82 - 91
KEL-EMC Cable collectors	224 - 226
ST Plugs	77



1.11
KEL-FL
Cable entry frames
for flat cables



Description	Cut-out Drilling template	Type	Order No.	Cut-out [mm]	Grommets KT FT	PU
		KEL-FLA	46100	43 x 24	0x KT 1x FT-1	10
		KEL-FLB	46105	65 x 24	0x KT 1x FT-2	10
		KEL-FLC	46110	65 x 24	1x KT 1x FT-1	10
		KEL-FLD	46115	86 x 24	0x KT 1x FT-3	10
		KEL-FL E	46120	86 x 24	1x KT 1x FT-2	10
		KEL-FL F	46125	86 x 24	0x KT 2x FT-1	10
		KEL-FL G	46130	86 x 24	2x KT 1x FT-1	10
		KEL-FL H	46135	112 x 24	2x KT 1x FT-2	10
		KEL-FL I	46140	112 x 24	1x KT 2x FT-1	10
		KEL-FL J	46145	112 x 24	3x KT 1x FT-1	10
		KEL-FL K	46150	112 x 24	1x FT-1 1x FT-2	10
		KEL-FL L	46155	112 x 24	1x FT-4	10

1.11
FT
Grommets for flat cables



Description	Type	Order No.	Clamping range	PU
	FT-1 0	46201	Blank grommet	5
	FT-1 A	46210	Width: 19 - 23 mm Thickness: 5.5 - 6 mm	5
	FT-1 B	46211	Width: 28 - 33 mm Thickness: 5.5 - 6 mm	5
	FT-1 C	46212	Width: 24 - 30 mm Thickness: 8.5 - 9 mm	5
	FT-1 E	46214	Width: 19 - 24 mm Thickness: 6.5 - 7 mm	5
	FT-1 F	46215	Width: 28 - 33 mm Thickness: 9 - 9.5 mm	5
	FT-2 0	46202	Blank grommet	5
	FT-2 A	46250	Width: 32.5 - 38 mm Thickness: 5 - 5.5 mm	5
	FT-2 B	46251	Width: 45 - 50.5 mm Thickness: 6 - 6.5 mm	5
	FT-2 C	46252	Width: 47 - 52 mm Thickness: 9.5 - 10 mm	5
	FT-2 F	46255	Width: 38 - 43 mm Thickness: 12.5 - 13 mm	5
	FT-2 G	46256	Width: 49 - 54 mm Thickness: 5 - 6 mm	5
	FT-3 0	46203	Blank grommet	5
	FT-3 A	46300	Width: 72 - 77 mm Thickness: 5 - 5.5 mm	5
	FT-4 0	46204	Blank grommet	5
	FT-4 A	46330	Width: 85 - 99 mm Thickness: 4.2 - 5.2 mm	5

The KEL-FL range enables simple, fast and flexible cable routing and sealing of flat wires, e.g. in lift construction.

Innovative construction of the grommets compensates for manufacturing inconsistencies in flat cables. Split KT grommets can be utilised to additionally route round cables with connectors. All frame systems come with a rubber gasket.

FT grommets are used to route flat cables, e.g. in lift construction. Suitable for cable entry frames KEL-FL. Innovative construction of the grommets compensates for manufacturing inconsistencies in flat cables.

Advantages & benefits

- Routing of flat cables in combination with pre-terminated round cables by using a single KEL-FL cable entry frame
- Routing of flat cables with various dimensions
- Space saving shape

Specifications

Material	KEL-FL: Polyamide (PA)
Flame class	FT: Elastomer
IP rating	UL 94 V-0, self-extinguishing IP54, with gasket and correct selection of the cable grommets
Temperature	KEL-FL: -40°C to +140°C (static) FT: -40°C to +100°C (static)
Properties	Halogen-free, silicone-free
Frame depth	17 mm

Accessories

KT Cable grommets, small	66 - 81
KTMB/KT-DPF Cable grommets, small	73 - 75
KEL-EMC Cable collectors	224 - 226
ST Plugs	77

1.11 Flange enclosure for 90° cable transit with integrated seal and IP65 rating
KEL-FG-ER series

The cable entry frames KEL-FG-ER are suited for installation of cables with connectors and conduits at an angle of 90° to the cabinet, enclosure or machine wall, providing an IP65 rating and strain relief according to EN 62444 for cable diameters from 1 to 16 mm (single-hole grommets KT 1 – 15) and 16 to 35 mm (single-hole grommets KT 16 – 34).

Due to the integrated seal on the flange enclosure, a protection class of up to IP65 is provided. An additional flat rubber gasket is included in the shipment.

The KEL-FG-ER-A frame matches exactly the cut-out dimensions for 24-pin standard industrial connectors (36 x 112 mm). The KEL-FG-ER-B is suited for cut-outs 36 x 46 mm.

The single-row version KEL-FG-ER-E is particularly suited for flat connectors. The small frame is ideal for applications with limited space.

The version with threaded bushings enables the cable entry frame to be screwed onto the housing from the inside out. This protects against vandalism and tampering with the housing from the outside.



Injected seal, highlighted here in red



Can be combined with IMAS-CONNECT adapter grommets

Advantages & benefits

- Integrated seal
- Installation at an angle of 90° to the wall
- Mechanical protection of the cable directly at the place of entry
- Protection against water splashes and drips
- Warranty on pre-terminated cables remains
- Ideal for cables with connectors (max. Ø 35 mm)
- Strain relief according to EN 62444
- High stability, vibration resistant
- Can be combined with IMAS-CONNECT adapter grommets

Specifications

Material	Polyamide (PA)
Flame class	UL 94 V-0, self-extinguishing
IP rating	IP54, IP55, IP64, IP65 according to EN 60529
Temperature	-40°C to +80°C (static)
Properties	Vibration proof, UV-resistant, silicone free, halogen free
Mounting height	57.5 mm

Accessories

KT Cable grommets	66 - 81
AT Adapter grommets	82 - 91
KEL-EMC Cable collectors	224 - 226
ST Plugs	77

1.11 KEL-FG-ER Flange enclosure for 90° cable transit
KEL-FG-ER A



Description	Cut-out Drilling template	Type	Cut-out mm	Grommets small large	Order No.	PU
		KEL-FG-ER A10	36 x 112	10 -	42340	1
		KEL-FG-ER A10 with V2A screws	36 x 112	10 -	42340.200	1
		KEL-FG-ER A10 with threaded bushings M4	36 x 112	10 -	42340.400	1
		KEL-FG-ER A7	36 x 112	6 1	42341	1
		KEL-FG-ER A7 with V2A screws	36 x 112	6 1	42341.200	1
		KEL-FG-ER A7 with threaded bushings M4	36 x 112	6 1	42341.400	1
		KEL-FG-ER A4	36 x 112	2 2	42342	1
		KEL-FG-ER A4 with V2A screws	36 x 112	2 2	42342.200	1
		KEL-FG-ER A4 with threaded bushings M4	36 x 112	2 2	42342.400	1

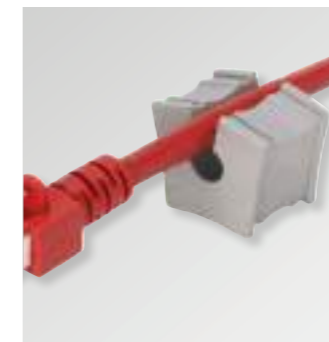

Split KT grommets

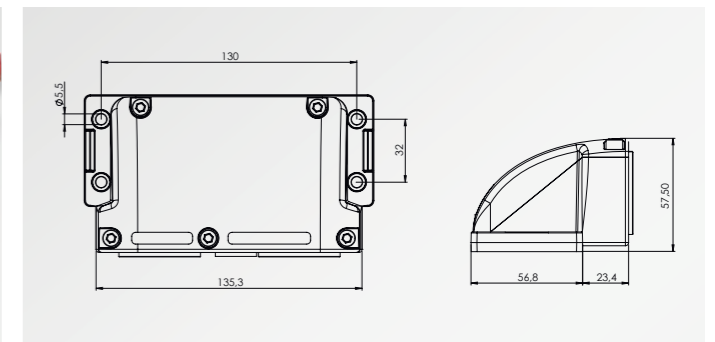

KEL-FG-ER
Flange enclosure
for 90° cable transit
KEL-FG-ER B



Description	Cut-out Drilling template	Type	Cut-out mm	Grommets small large	Order No.	PU
		KEL-FG-ER B4	46 x 36	4 -	42344	1
		KEL-FG-ER B4 with V2A screws	46 x 36	4 -	42344.200	1
		KEL-FG-ER B4 with threaded bushings M4	46 x 36	4 -	42344.400	1
		KEL-FG-ER B1	46 x 36	- 1	42343	1
		KEL-FG-ER B1 with V2A screws	46 x 36	- 1	42343.200	1
		KEL-FG-ER B1 with threaded bushings M4	46 x 36	- 1	42343.400	1

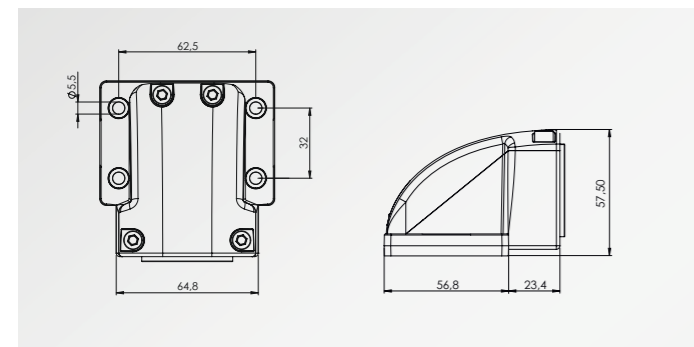

KEL-FG-ER
Flange enclosure
for 90° cable transit
KEL-FG-ER E



Description	Cut-out Drilling template	Type	Cut-out mm	Grommets small large	Order No.	PU
		KEL-FG-ER E2	43 x 24	2 -	42345	5
		KEL-FG-ER E2 with V2A screws	43 x 24	2 -	42345.200	5
		KEL-FG-ER E2 with threaded bushings M4	43 x 24	2 -	42345.400	5
		KEL-FG-ER E3	65 x 24	3 -	42346	5
		KEL-FG-ER E3 with V2A screws	65 x 24	3 -	42346.200	5
		KEL-FG-ER E3 with threaded bushings M4	65 x 24	3 -	42346.400	5
		KEL-FG-ER E5	112 x 24	5 -	42347	5
		KEL-FG-ER E5 with V2A screws	112 x 24	5 -	42347.200	5
		KEL-FG-ER E5 with threaded bushings M4	112 x 24	5 -	42347.400	5

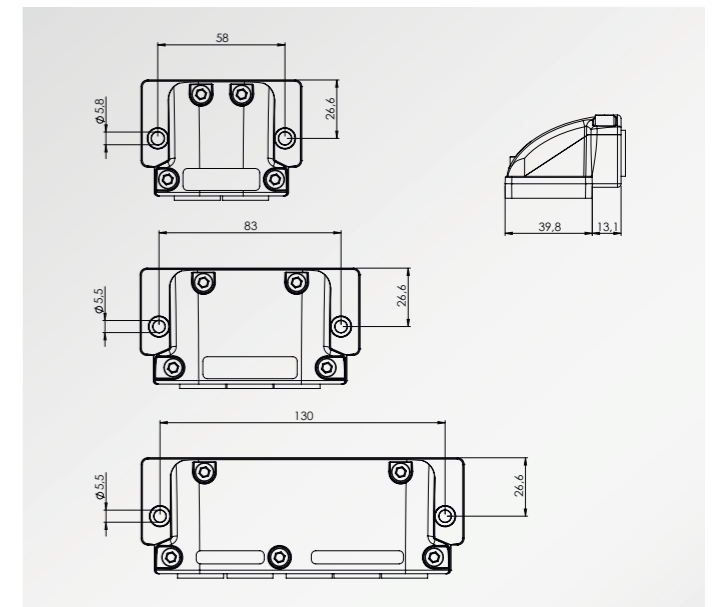

1.11 Flange enclosure for 90° cable transit with IP54 rating **KEL-FG series**

The cable entry frames KEL-FG are suited for installation, sealing and strain relief of cables with connectors and conduits at an angle of 90° to the cabinet, enclosure or machine wall.

The KEL-FG-A frame matches exactly the cut-out dimensions for 24-pin standard industrial connectors. For tool-free assembly/disassembly of the KEL-FG-A the snap mounting frame KEL-SNAP 24 can be used. The KEL-FG-B is suited for cut-outs 36 x 46 mm.

The single-row versions KEL-FG-E are particularly suited for flat connectors. The small frames are ideal for applications with limited space.

The version with threaded bushings enables the cable entry frame to be screwed onto the housing from the inside out. This protects against vandalism and tampering with the housing from the outside.

A flat rubber gasket is included in the shipment.



The cable entry frames enable the integration of the IMAS-CONNECT™ adapter grommets

Advantages & benefits

- Installation at an angle of 90° to the wall
- Mechanical protection of cable directly at the place of entry
- Protection against water spray and drips
- Maintain manufacturer's warranty on pre-terminated cables
- Strain relief according to EN 62444
- High stability, vibration resistant
- Can be combined with IMAS-CONNECT adapter grommets



Also available with stainless steel screws (V2A)



Also available with threaded bushings

Specifications

Material	Polyamide (PA)
Flame class	UL 94 V-0, self-extinguishing
IP rating	IP54, with gasket and correct selection of the cable grommets
Temperature	-40°C to +140°C (static)
Properties	Halogen-free, silicone-free

Accessories

KT Cable grommets	66 - 81
AT Adapter grommets	82 - 91
KEL-SNAP Mounting frames	46 - 49
KEL-EMC Cable collectors	224 - 226
ST Plugs	77



1.11 **KEL-FG** Flange enclosure for 90° cable transit **KEL-FG-A**



Description	Cut-out Drilling template	Type	Cut-out mm	Grommets small large	Order No.	PU
		KEL-FG-A10	36 x 112	10 -	42320	1
		KEL-FG-A10 with V2A screws	36 x 112	10 -	42320.200	1
		KEL-FG-A10 with threaded bushings M4	36 x 112	10 -	42320.400	1
		KEL-FG-A7	36 x 112	6 1	42322	1
		KEL-FG-A7 with V2A screws	36 x 112	6 1	42322.200	1
		KEL-FG-A7 with threaded bushings M4	36 x 112	6 1	42322.400	1
		KEL-FG-A4	36 x 112	2 2	42324	1
		KEL-FG-A4 with V2A screws	36 x 112	2 2	42324.200	1
		KEL-FG-A4 with threaded bushings M4	36 x 112	2 2	42324.400	1



KEL-FG-A

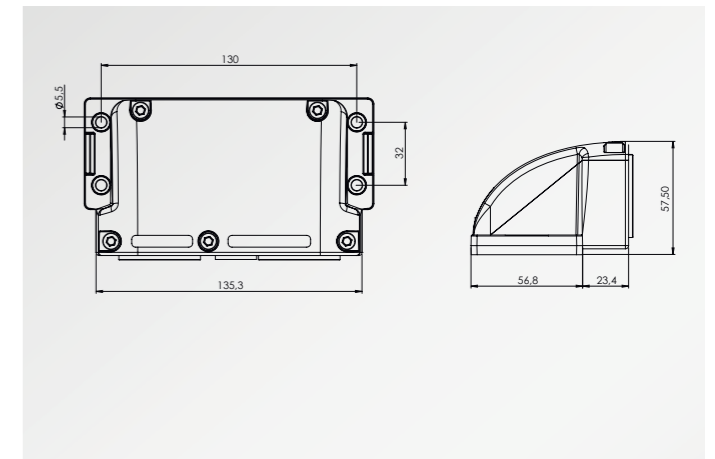

KEL-FG
Flange enclosure
for 90° cable transit
KEL-FG-B

IP54



Description	Cut-out Drilling template	Type	Cut-out mm	Grommets small large	Order No.	PU
		KEL-FG-B4	46 x 36	4 -	42330	1
		KEL-FG-B4 with V2A screws	46 x 36	4 -	42330.200	1
		KEL-FG-B4 with threaded bushings M4	46 x 36	4 -	42330.400	1
		KEL-FG-B1	46 x 36	- 1	42332	1
		KEL-FG-B1 with V2A screws	46 x 36	- 1	42332.200	1
		KEL-FG-B1 with threaded bushings M4	46 x 36	- 1	42332.400	1

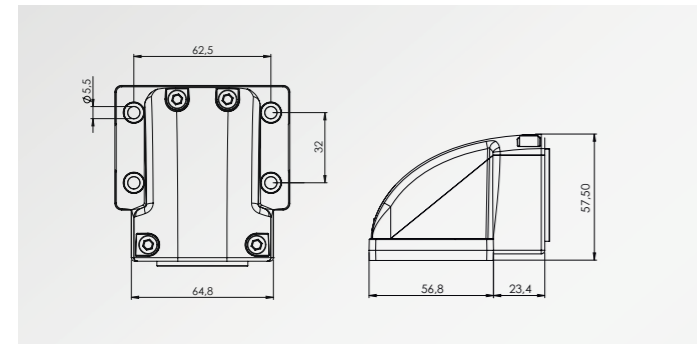

KEL-FG
Flange enclosure
for 90° cable transit
KEL-FG-E

IP54



Description	Cut-out Drilling template	Type	Cut-out mm	Grommets small large	Order No.	PU
		KEL-FG-E2	43 x 24	2 -	42333	5
		KEL-FG-E2 with V2A screws	43 x 24	2 -	42333.200	5
		KEL-FG-E2 with threaded bushings M4	43 x 24	2 -	42333.400	5
		KEL-FG-E3	65 x 24	3 -	42334	5
		KEL-FG-E3 with V2A screws	65 x 24	3 -	42334.200	5
		KEL-FG-E3 with threaded bushings M4	65 x 24	3 -	42334.400	5
		KEL-FG-E5	112 x 24	5 -	42336	5
		KEL-FG-E5 with V2A screws	112 x 24	5 -	42336.200	5
		KEL-FG-E5 with threaded bushings M4	112 x 24	5 -	42336.400	5

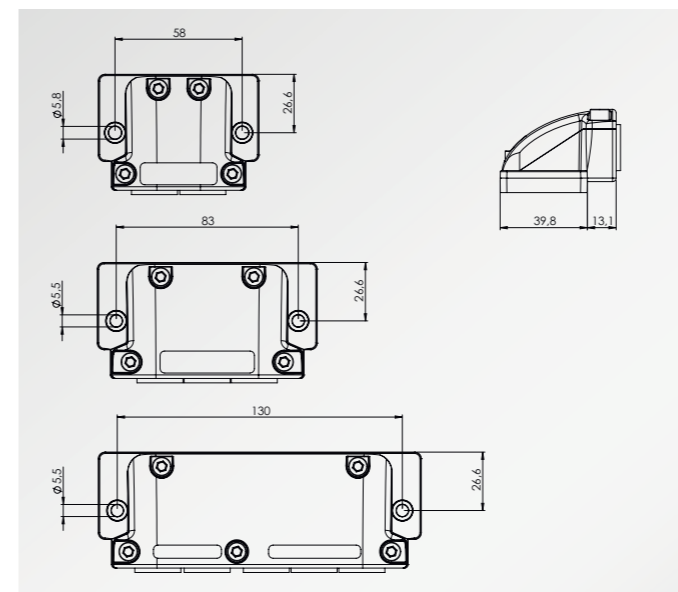

Single-piece packaging units are available on request.

1.11 Bulkhead for 90° cable transit with IP65 rating
KEL-FW

The hinged cover of the new bulkhead KEL-FW is firmly connected to the housing by a hinge and is therefore captive. This makes the system very easy and quick to mount. The KEL-FW is first screwed to the enclosure using the two rear holes and then fitted with the required cable grommets. The cover is then folded down, locked in place and screwed to the enclosure using the two front holes.

The KEL-FW is fitted with an integrated seal to achieve the high protection rating of IP65. An additional flat gasket for wall mounting is included in the shipment.

Cables with and without connectors up to a diameter of 35 mm can be routed and strain-relieved according to DIN EN 62444. Retrofitting and maintenance can be carried out quickly and easily.

Advantages

- Captive cover
- Integrated seal
- Cable entry at 90° to the enclosure
- Mechanical protection of the cable directly at the place of entry
- Protection against water splashes and drips
- Warranty on pre-terminated cables remains
- Retrofittings and maintenance can be done quickly and easily
- Ideal for cables with connectors (max. Ø 35 mm)
- Strain relief according to EN 62444
- High stability, vibration resistant
- Can be combined with IMAS-CONNECT adapter grommets

Specifications

Material	Polyamide (PA)
Colour	Black (RAL 9005)
IP rating	IP65 (certified acc. to EN 60529)
Flame class	UL 94 V-0, self-extinguishing
Temperature	-40°C to +140°C (static)
Properties	Halogen free, silicone free

Accessories

CONFIX Sheet metal punches	322
KT Cable grommets	66 - 81
IMAS-CONNECT Adapter grommets	82 - 91



1.11 KEL-FW Bulkhead for 90° cable transit with IP65 rating



Description	Cut-out Drilling template	Type	Dimension A x B x H mm	Cut-out mm	Bore ø	Grommets small large	Order No.	PU
		KEL-FW-B1	121,5 x 100,5 x 75,0	53 x 60,5 r = 30,25	4 x 6,5 mm	- 1	42460	5
		KEL-FW-B4	121,5 x 100,5 x 75,0	53 x 60,5 r = 30,25	4 x 6,5 mm	4 -	42461	5

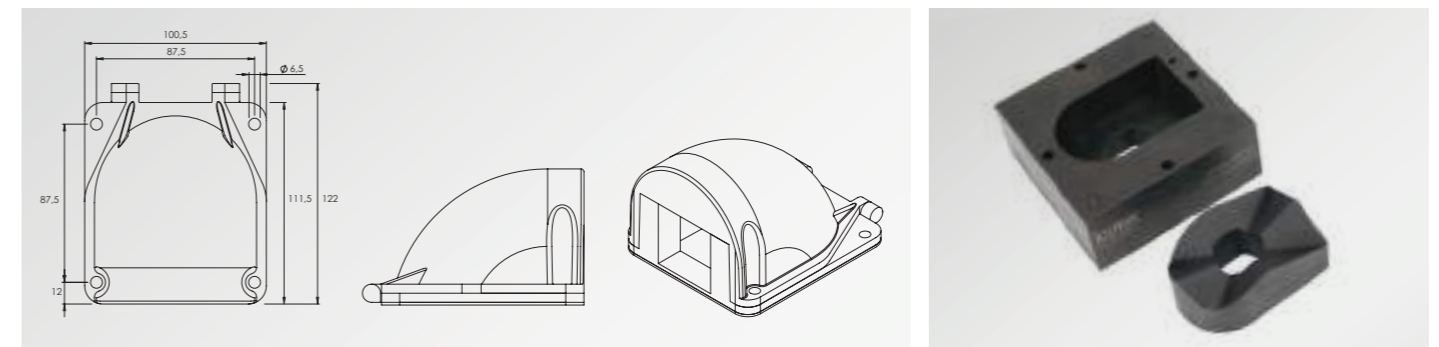

Matching sheet metal punches on p. 322

Split snap-on mounting frames with IP54 rating
KEL-SNAP-S

icotek also offers the proven snap-on frame KEL-SNAP as a split version KEL-SNAP-S. The snap-in frames enable quick and tool-free assembly of the KEL-FA/KEL/KEL-U/KEL-QUICK/KEL-FG-A cable entry systems.

The KEL-SNAP becomes even more versatile with the "S" version. Due to the divisibility of the snap-on frame, it can also be retrofitted without any problems. If an already mounted KEL-SNAP is damaged, it can be replaced by a split frame without having to disconnect all the cables that have already been fed through and without having to dismantle the existing KEL.

Advantages & benefits

- Subsequent assembly possible
- Upon disassembly (e.g. maintenance) screwing and unscrewing of the cable entry frame is not necessary
- Drilling template identical to cable entry frame
- Integrated gasket
- Previously assembled cable harnesses are quickly and easily attached
- There is no need to thread the cables through the snap-on frame as the divisible frame can be snapped together when the cables have already been passed through the cut-out

Specifications

Material	Polyamide (PA)
IP rating	IP 54
Flame class	UL 94 V-0, self-extinguishing
Temperature	-40°C bis +140°C (static)
Properties	silicone free, halogen free

Compatible with

KEL-FA Cable entry frames	18 - 21
KEL Cable entry frames	22 - 31
KEL-U Cable entry frames	14 - 16
KEL-FG Flange enclosure	40 - 43
KEL-QUICK Cable entry frames	96 - 97
MP Module plates	270 - 271
BPK-SNAP Blank plates	288



Integrated circumferential seal (IP54) Snap-in locking hook

KEL-SNAP-S
Splittable snap-on mounting frame



IP54

Description	Cut-out Drilling template	Type	Cut-out [mm]	Suitable for	Order No.	PU
		KEL-SNAP-S-B	46 × 38	KEL-B KEL-U-B KEL-QUICK-B	42063	10
		KEL-SNAP-S-10	46 × 65	KEL 10 KEL-U 10 KEL-QUICK 10	42062	10
		KEL-SNAP-S-16	46 × 85	KEL 16 KEL-U 16 KEL-QUICK 16	42061	10
		KEL-SNAP-S-24	46 × 112	KEL 24 KEL-U 24 KEL-FG-A KEL-QUICK 24	42060	10

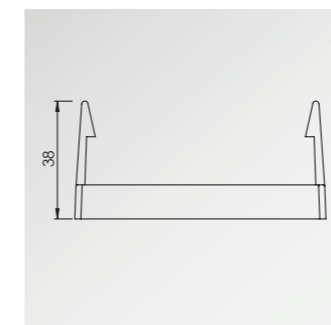

Single-piece packaging units are available on request.

1.11 Snap-on mounting frames with IP54 rating **KEL-SNAP**

KEL-SNAP Snap mounting frames 1.11

The patented KEL-SNAP frame provides a quick snap-in assembly of the KEL-FA/KEL/KEL-U/KEL-QUICK/KEL-FG-A cable entry systems. Control panels, cabinets or machines can be equipped with the KEL-SNAP frame at delivery, allowing a simple push in of the KEL frame when routing cables and conduit. Perfect for enclosures that are maintenance intensive or for an install at a later date.

A cut-out of 46 mm can also be chosen instead of 36 mm. Thus prefabricated multi-pin connectors can be used.

Advantages & benefits

- Upon disassembly (e.g. maintenance) screwing and unscrewing of KEL frame is not necessary
- Previously assembled KEL frames are quickly and easily attached
- Integrated gasket
- Drilling template identical to KEL frame (except KEL-SNAP-B)

Specifications

Material	Polyamide (PA)
Flame class	UL94V-0, self-extinguishing
IP rating	IP54 (certified acc. to EN 60529)
UL type rating	UL type 12 (acc. to UL 50E)
Temperature	-40°C to +140°C (static)
Properties	Halogen-free, silicone-free

Compatible with

KEL-FA Cable entry frames	18 - 21
KEL Cable entry frames	22 - 31
KEL-U Cable entry frames	14 - 16
KEL-FG Flange enclosure	40 - 43
KEL-QUICK Cable entry frames	96 - 97
MP Module plates	270 - 271
BPK-SNAP Blank plates	288



Integrated circular sealing (IP54)



Blank plate BPK-SNAP, see page 288

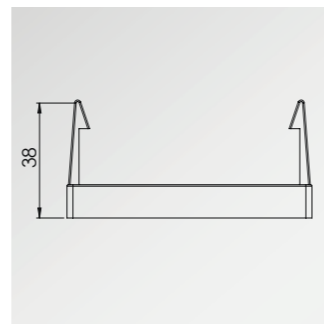

IP54

Description	Cut-out Drilling template	Type	Cut-out [mm]	Suitable for	Order No.	PU
		KEL-SNAP-B	46 x 38	KEL-B KEL-U-B KEL-QUICK-B	42038	10
		KEL-SNAP 10	46 x 65	KEL 10 KEL-U 10 KEL-QUICK 10	42039	10
		KEL-SNAP 16	46 x 85	KEL 16 KEL-U 16 KEL-QUICK 16	42040	10
		KEL-SNAP 24	46 x 112	KEL 24 KEL-U 24 KEL-FG-A KEL-QUICK 24	42042	10
		KEL-SNAP 24-E	71 x 112	KEL 24-E	42044	1
		KEL-SNAP 24-MT	89 x 112	KEL 24-MT	42046	1

i Single-piece packaging units are available on request.

KEL-JUMBO
Cable entry frames
for supply cables

IP54



Description	Cut-out Drilling template	Type	Order No.	Dimensions length width height	PU
		KEL-JUMBO 1	42360	110 × 116 × 35 mm	1
		KEL-JUMBO 1 with V2A screws	42360.200	110 × 116 × 35 mm	1
		KEL-JUMBO 2	42350	200 × 116 × 35 mm	1
		KEL-JUMBO 2 with V2A screws	42350.200	200 × 116 × 35 mm	1



KTF, KTF-SCDP
Grommets for KEL-JUMBO

IP54



Type	Order No.	Clamping range	PU
KTF 00	42371	Blank grommet	1
KTA	42370	Adapter grommet for KT large	1
KTF 34	42376	33 – 36 mm	1
KTF 38	42379	37 – 40 mm	1
KTF 42	42382	41 – 44 mm	1
KTF 46	42385	45 – 48 mm	1
KTF 50	42388	48 – 52 mm	1
KTF 54	42391	53 – 56 mm	1
KTF 58	42394	56 – 60 mm	1
KTF 62	42397	61 – 65 mm	1
KTF-SCDP-A NEW	42398	8 – 55 mm	1

The KEL-JUMBO cable entry system for installation of cables and conduits with a diameter of up to 65 mm, especially suited for supply cables.

The innovative grommet design with the flex-membrane provides flexing and adjustment of the position for larger and more rigid cables.

We recommend round cut-outs, which can be made using standard punching tools. Suggested cut-out: cable diameter +15–20%. All frame systems come with a rubber gasket.

The KTF grommets are suitable for cable diameters up to 65 mm.

The new adaptable KTF-SCDP cable grommet enables the routing and sealing of supply cables and conduits with diameters up to 55 mm.

Cables with a comparatively smaller diameter can be utilised with KEL-JUMBO frames by using an adapter grommet.

Advantages & benefits

- Installation of cables up to 65 mm
- KTF grommets allow flexing and adjustment of the cable position
- Retrofitting and maintenance can be carried out easily and quickly

Specifications

Material	KEL-JUMBO: Polyamide (PA) KTF, KTF-SCDP: Elastomer
Flame class	UL 94 V-0, self-extinguishing
IP rating	IP54
UL type rating	UL type 12 (acc. to UL 50E)
Temperature	KEL-JUMBO: -40°C to +140°C (static) KTF, KTF-SCDP: -40°C to +100°C (static)
Properties	Halogen-free, silicone-free
Cut-out dimensions	Round, cable diameter +15%
Frame depth	35 mm

Accessories

KDR-ESR Base plates	258 - 267
KDR2 Split base plates	268 - 269
MP Module plates	270 - 271

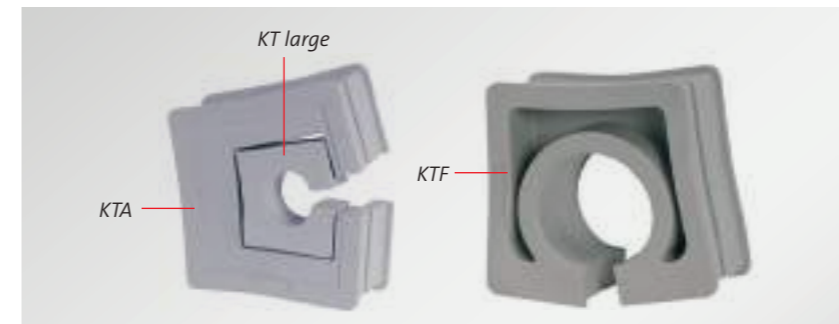

1.12 Split cable glands for the KT grommet system

1.12

1.12



By using icotek's split cable glands, cables with or without connectors or complete cable harnesses with diameters from 1 to 35 mm can be quickly routed into enclosures, cabinets or machines and achieve protection levels up to IP66/IP68/UL type 4X rated.

The split system of the KVT cable glands enables quick and easy assembly which is great for retrofitting and maintenance. The cable is placed into the split grommet which is set into one of the gland halves.

Depending on the size of the cable gland one, two, four or six separate grommets can be installed. The two gland halves can be easily snapped together without the need of tools. The routed lines are securely sealed and held inside the grommets.

To mount the cable gland either snap it into the round metric standard cut-out (sizes available from M20 to M80) or screw it with a hexagonal locknut. The mounting method is dependent on which model is being used.

- Screwable or pluggable.** (Icon: screw)
- By screwing the top section of the split cable gland to its body, a higher clamping pressure can be achieved (stainless steel screws by default).** (Icon: gland top)
- Integrated seal** (Icon: seal detail)
- Split system** (Icon: split gland)
- Warranty on pre-terminated cables remains** (Icon: cable with connector)
- Special locknuts for e.g. D-Sub or PROFIBUS connectors as well as split locknuts available.** (Icon: locknuts)
- Fast and easy assembly** (Icon: stopwatch)
- For metric cut-outs M20 – M80** (Icon: cut-out with diameter symbol)
- High cable density, wide variety in cable grommets** (Icon: various grommet types)
- Very good strain relief acc. to EN 62444** (Icon: strain relief detail)



KVT-ER 63|4 equipped with 1x pressure compensation element, see page 89.



Split cable glands for screw-in assembly, M25 – M63, for cable diameters up to 35 mm

KVT-ER

54 – 55



Split cable glands for screw-in assembly, M20 – M63, for cable diameters up to 35 mm

KVT

56 – 57

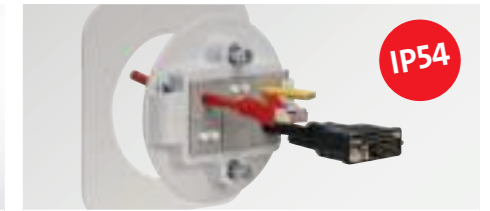

Split cable glands for screw-in assembly, M80, for cable diameters up to 35 mm

KVT 80

58



Split cable glands for snap-in assembly, M32 – M63, for cable diameters up to 35 mm

KVT-SNAP

59



Split cable glands for 90° cable transit, for screw-in assembly, M32 – M50, for cable diameters up to 35 mm

KVT-W90

60



Cable grommets split and not split, for cables with/without connectors, for cable diameters 1 – 35 mm

66 – 81



IMAS-CONNECT™ Modular adapter system for the KT system

82 – 91



Thread extension for cable glands and cable entry plates M32, M50, M63

TE-M

290 – 291

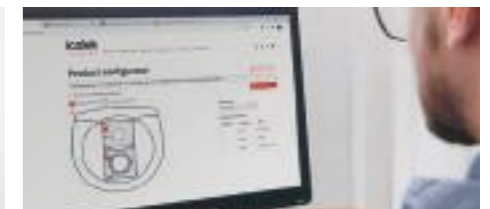

Product configurator www.icotek.com/en/config

61

Split cable glands with IP66/IP68 rating
KVT-ER series



Certified protection class IP65/IP66/IP67/IP68



Split KT grommets



With stainless steel screws (V2A)



Injected elastomer gasket

Advantages & benefits

- Very high strain relief according to EN 62444
- Maintain manufacturer's warranty on pre-terminated cables
- Retrofittings, repairs and maintenance can be done easily and quickly
- Suitable for metric cut-outs
- High cable density, wide variety of grommets
- Hexagonal lock nut included in the delivery
- V2A stainless steel screws
- Very robust housing, vibration resistant
- Modern design

Specifications

Material	Frame: Polypropylene (PP) Injected gasket: Elastomer
Flame class	UL 94 V-0, self-extinguishing
IP rating	IP65/IP66/IP67/IP68, if correctly assembled with single grommets (certified acc. to EN 60529)
Temperature Properties	-40°C to +110°C (static) Halogen-free, silicone-free
Cut-out dimension	Metric sizes

Accessories

KT Cable grommets	66 - 81
AT Adapter grommets	82 - 91
KVT-EMC Brackets	227
Locknuts	292
ST Plugs	77

Locknuts

Locknuts with special cut-outs are available separately.



KGM-SUB-D9
fits D-Sub 9 connectors
(Required wall cut-out:
Ø 36 mm, PU: 10)
■ Order No. 45106

KGM-SUB-D25
fits SUB-D25 connectors
(Required wall cut-out:
Ø 50 - 54 mm, PU:10)
■ Order No. 45110

Type GMT: Split locknut, p. 292

KVT-ER Split cable glands



IP66 IP68

Description	Type	Order No.	Grommets KT small large	Cut-out** diameter	Thread Thread length	PU
	KVT-ER 25*	45450	1 -	25.5 mm	M25 x 1.5 Length: 18 mm	10
	KVT-ER 32	45452	1 -	32.5 mm	M32 x 1.5 Length: 18 mm	10
	KVT-ER 50 2	45454	2 -	50.5 mm	M50 x 1.5 Length: 18 mm	5
	KVT-ER 63 1	45455	- 1	63.5 mm	M63 x 1.5 Length: 18 mm	5
	KVT-ER 63 4	45456	4 -	63.5 mm	M63 x 1.5 Length: 18 mm	5

* Max. cable diameter of 15 mm
** Please consider any paint layers or powder coatings!

Single-piece packaging units are available on request.

Split cable glands with IP54 rating
KVT series



KVT is a circular split frame for quick and easy installation and sealing of cables with connectors or complete cable harnesses.

Polyamide locknuts as well as a sealing ring are included in the shipment.

For routing D-Sub, DVI or PROFIBUS connectors in combination with the split cable glands KVT, special locknuts with cut-outs are required.

Advantages & benefits

- Insertion of pre-terminated cables
- Maintain manufacturer's warranty on pre-terminated cables
- Retrofits, repairs and maintenance can be done much more easily and quickly
- High cable density, wide variety of grommets
- Suitable for metric cut-outs
- Locknut is included

Specifications

Material	Polycarbonate (PC)
Colour	■ grey (similar RAL 7035) ■ black
Flame class	UL 94 V-0, self-extinguishing
IP rating	IP54, with gasket and correct selection of the cable grommets (certified acc. to EN 60529)
UL type rating	UL type 12 (acc. to UL 50E)
Temperature	-30°C to +100°C (static)
Properties	Halogen-free, silicone-free
Cut-out dimension	Metric sizes

Accessories

KT Cable grommets	66 - 81
AT Adapter grommets	82 - 91
KVT-EMC Brackets	227
Locknuts	292
ST Plugs	77

Description	Type	Order No.	Grommets small large	Thread Thread length	PU
	KVT 20**	■ 45034 ■ 45024	1 -	M20 × 1.5 Length: 14 mm	10
	KVT 25***	■ 45035 ■ 45025	1 -	M25 × 1.5 Length: 14 mm	10
	KVT 32	■ 45036 ■ 45026	1 -	M32 × 1.5 Length: 14 mm	10
	KVT 32 + KGM-SUB-D9	■ 45037 ■ 45027	1 -	M32 × 1.5 Length: 14 mm	10



i Single-piece packaging units are available on request.

* Only valid for grey product types | ** Max. cable diameter of 11 mm | *** Max. cable diameter of 15 mm

KVT Split cable glands

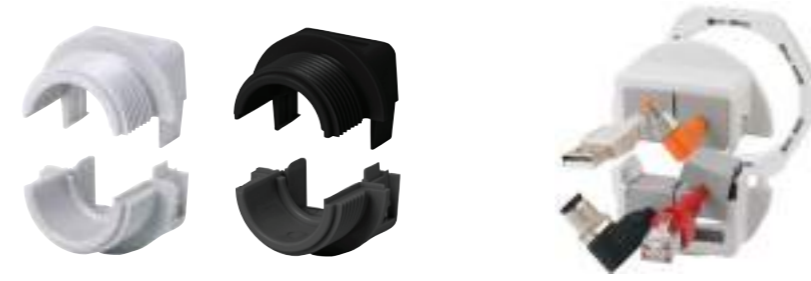

Description	Type	Order No.	Grommets small large	Thread Thread length	PU
	KVT 40	■ 45203 ■ 45028	1 -	M40 × 1.5 Length: 14 mm	10
	KVT 40 + KGM-PB	■ 45205 ■ 45029	1 -	M40 × 1.5 Length: 14 mm	10
	KVT 50 2*	■ 45204 ■ 45030	2 -	M50 × 1.5 Length: 14 mm	5
	KVT 50 2* + KGM-SUB-D25	■ 45206 ■ 45031	2 -	M50 × 1.5 Length: 14 mm	5
	KVT 63 1	■ 45212 ■ 45112	- 1	M63 × 1.5 Length: 14 mm	5
	KVT 63 4	■ 45215 ■ 45115	4 -	M63 × 1.5 Length: 14 mm	5



The cable glands enable the integration of the IMAS-CONNECT™ adapter grommets

i Single-piece packaging units are available on request.

* Only valid for grey product types | * cannot be combined with adapter grommet AT-K-M

IP54

Locknuts

Locknuts with special cut-outs are available separately. The cut-out dimensions are listed on page 292.



KGM-SUB-D9 fits D-Sub 9 connectors (Required wall cut-out: Ø 36 mm, PU: 10)
■ Order No. 45105 ■ Order No. 45106

KGM-PB fits DVI and PROFIBUS connectors (Required wall cut-out: Ø 42 mm, PU: 10)
■ Order No. 45107 ■ Order No. 45109

KGM-SUB-D25 fits SUB-D25 connectors (Required wall cut-out: Ø 50 - 54 mm, PU:10)
■ Order No. 45108 ■ Order No. 45110



KVT 80

Split cable glands for front mounting

IP54



The KVT 80 split cable glands are designed for routing and sealing cables with connectors. By assembling the two frame halves with the screws provided, the grommets provide sufficient pressure on the routed cables to obtain a high degree of strain relief. The KVT 80 can be fitted to a wall thickness from 1.5 mm to 10 mm. A flat rubber gasket is included in the shipment.

Advantages & benefits

- Insertion of pre-terminated cables
- Maintain manufacturer's warranty on pre-terminated cables
- Retrofittings, repairs and maintenance can be done much more easily and quickly
- High cable density, wide variety of grommets
- Fast and easy mounting from the front
- Strain relief according to EN 62444

Note

When mounting the KVT 80 on sheet metal, we recommend the following torque values:
1.5 mm sheet = 1 Nm | 2 – 10 mm sheet = 1.5 Nm

Specifications

Material	Polycarbonate (PC)
Colour	■ grey (similar RAL 7035) ■ black
Flame class	UL 94 V-0, self-extinguishing
IP rating	IP54, with gasket and correct selection of the cable grommets (certified acc. to EN 60529)
UL type rating	UL type 12 (acc. to UL 50E)
Temperature	-30°C to +100°C (static)
Properties	Halogen-free, silicone-free
Cut-out dimension	80 mm in diameter

Accessories

Cable grommets	66 - 81
ST Plugs	77

Description	Type	Order No.	Grommets KT small large	PU
	KVT 80 3	■ 45236	2 1	1
		■ 45239		
	KVT 80 6	■ 45237	6 -	1
		■ 45238		

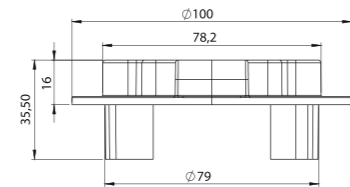

*Only valid for grey product types

KVT-SNAP

Split pluggable cable glands

IP54



Description	Type	Order No.	Grommets small large	Thread Thread length	PU
	KVT-SNAP 32	45130	1 -	M32 × 1.5 Length: 11 mm	10
	KVT-SNAP 40	45134	1 -	M40 × 1.5 Length: 11 mm	10
	KVT-SNAP 63 4 + KGM 63	45152	4 -	M63 × 1.5 Length: 11 mm	5
	KVT-SNAP 63 1 + KGM 63	45154	- 1	M63 × 1.5 Length: 11 mm	5
	KGM 32	■ 52275 ■ 52285	PA	M32 × 1.5	10
	KGM 40	■ 52276 ■ 52286	PA	M40 × 1.5	10
	KGM 63	■ 52278 ■ 52288	PA	M63 × 1.5	5

KVT is a circular split frame for quick and easy installation of cables with connectors or complete cable harnesses.

By using the model KVT-SNAP, cables can be routed through thick walls (> 5 mm) e.g. into cast terminal boxes without the use of tools. A sealing ring is included in the shipment.

Assembly

- The snap ring is screwed into metric thread or tapped into the cut-out (it can also be fastened with a locknut, which is included in the shipment of KVT-SNAP 63)
- Once the snap ring is affixed to the housing the equipped KVT is simply pushed into it. Fast and easy installation!

Specifications

Material	Polycarbonate (PC)
Colour	■ grey (similar RAL 7035)
Flame class	UL 94 V-0, self-extinguishing
IP rating	IP54, with gasket and correct selection of the cable grommets (certified acc. to EN 60529)
Temperature	-30°C to +100°C (static)
Properties	Halogen-free, silicone-free
Cut-out dimension	Metric cut-outs

Accessories

Cable grommets	66 - 81
KVT-EMC Brackets	227
KGM Locknuts	292
ST Plugs	77



Single-piece packaging units are available on request.

*Only valid for grey product types

KVT-W90
for 90° cable transit,
split cable glands



The split KVT-W90 cable glands are used to insert and seal pre-terminated cables and conduits at a 90° angle.

In particular, the KVT 50-W90 is perfectly suited to hold corrugated or smooth hoses. A large number of cable entry grommets is available to the user.

Polyamide standard locknuts as well as a sealing ring are included in the shipment. Split locknuts can be ordered separately.

Advantages & benefits

- Installation at an angle of 90° to the cabinet
- Insertion of pre-terminated cables and conduits
- Maintain manufacturer's warranty on pre-terminated cables
- Suitable for metric cut-outs

Specifications

Material	Polycarbonate (PC)
Colour	<input type="checkbox"/> grey (similar RAL 7035) <input type="checkbox"/> black
Flame class	UL 94 V-0, self-extinguishing
IP rating	IP54, with gasket and correct selection of the cable grommets (certified acc. to EN 60529)
Temperature Properties	-30°C to +100°C (static)
Cut-out dimension	Metric cut-outs

Accessories

Cable grommets	66 - 81
KVT-EMC Brackets	227
KGM Locknuts	292
ST Plugs	77

Description	Type	Order No. with locknut	Grommets small large	Thread Thread length	PU
	KVT 32-W90	<input type="checkbox"/> 45404 <input type="checkbox"/> 45406	1 -	M32 × 1.5 Length: 115 mm	10
	KVT 50 4-W90	<input type="checkbox"/> 45424 <input type="checkbox"/> 45426	4 -	M50 × 1.5 Length: 115 mm	5
	KVT 50 1-W90	<input type="checkbox"/> 45414 <input type="checkbox"/> 45416	- 1	M50 × 1.5 Length: 115 mm	5



Single-piece packaging units are available on request.

*Only valid for grey product types



The practical product configurator

With the product configurator, you can now assemble your cable entry system with the required cable or adapter grommets.

Check it out: www.icotek.com/en/config

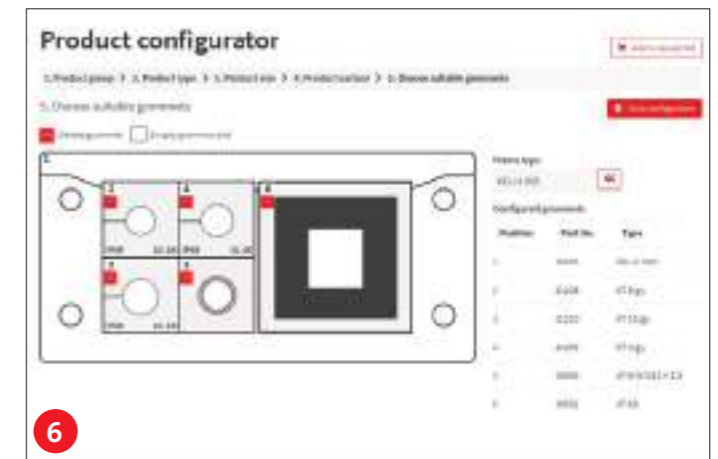
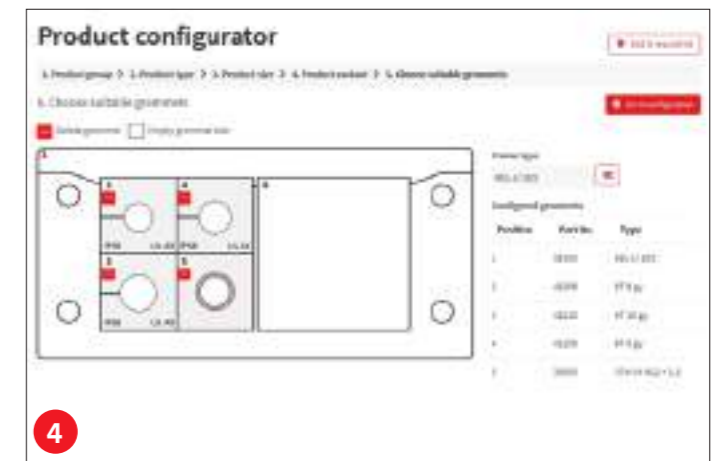
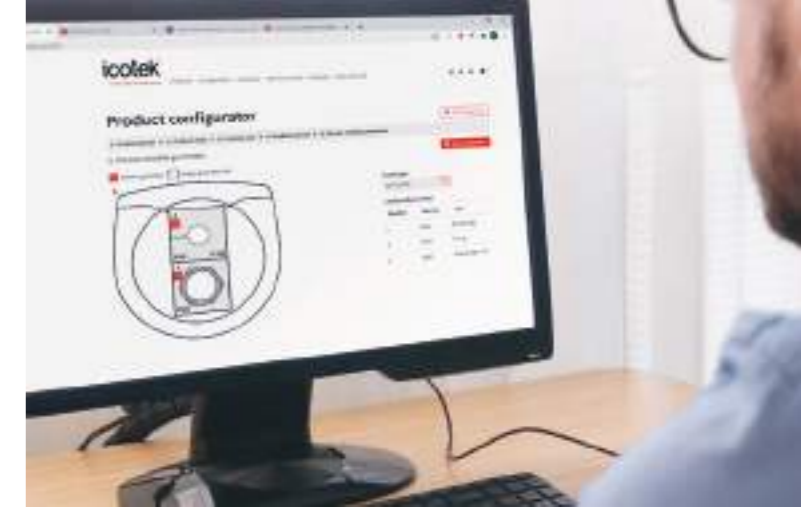

1.13 Distribution Box for 360° cable entry

1.13

NEW IP54 C_{UL} US in progress HL3 EN 45545-2 ECOLAB certified RoHS compliant Made in Germany +140°C -40°C 1-15mm

The 360° cable entry for cables with and without connectors

With the new distribution box, centrally routed cables can be distributed 360° in any direction. Cables with and without connectors can be routed, sealed with IP54 (certified according to DIN EN 60529) and at the same time strain-relieved according to DIN EN 62444.

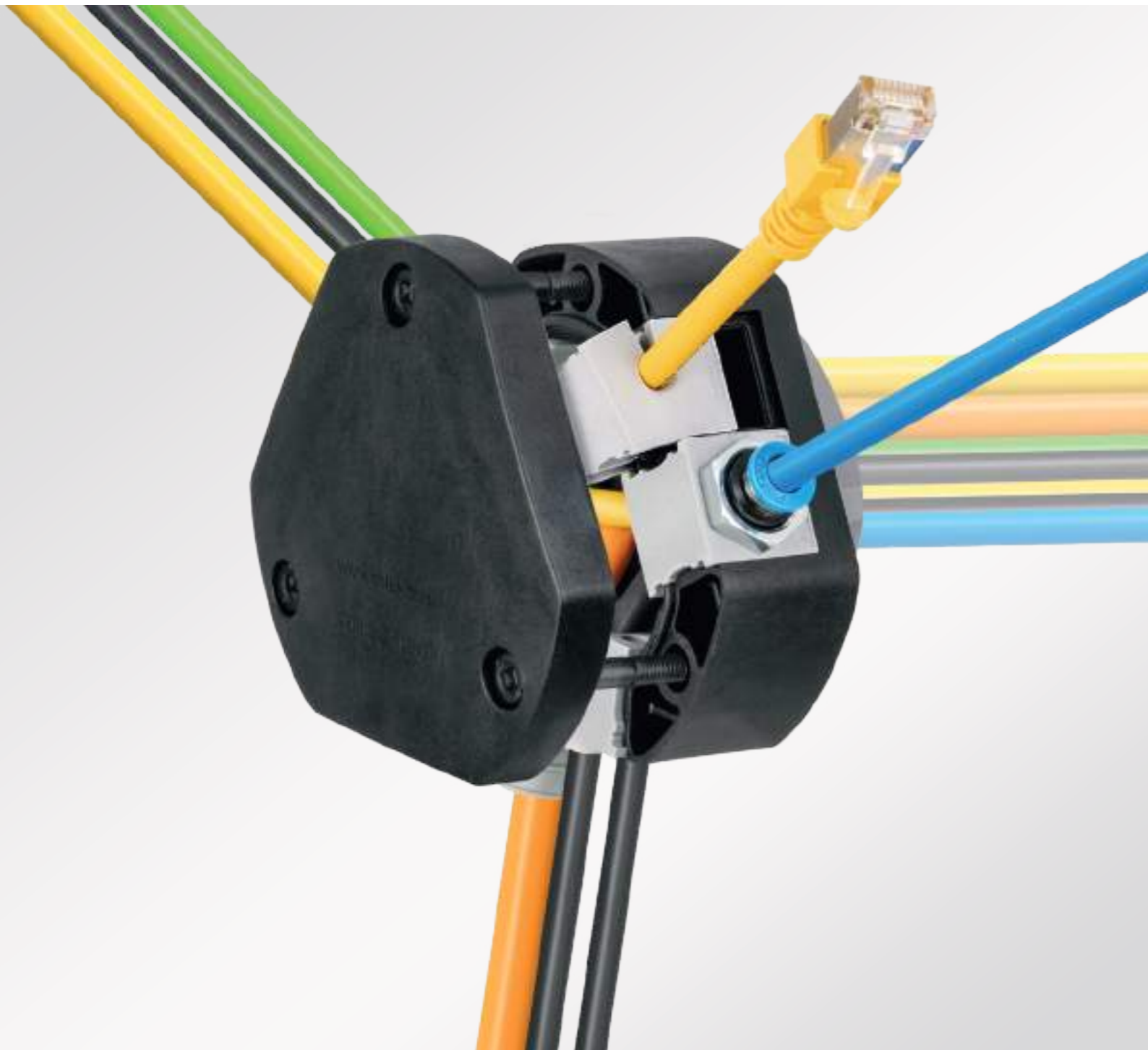

Easy distribution of cables in a 360° angle

Innovative design

Metric thread, suitable for metric cut-outs M32 – M75

Material Polyamide (PA)

High cable density, wide variety of grommets

Strain relief according to EN 62444

Screw-on cover, captive screws

Use of the proven KT grommet system as well as IMAS-CONNECT™ adapter grommets

Separate flat gasket included in the delivery

Hexagonal locknut included in the delivery

360° cable entry
with IP54 rating
DB Distribution Box

1.13

With the new distribution box, centrally routed cables can be distributed 360° in any direction.

Cables with and without connectors can be routed, sealed with IP54 (certified according to DIN EN 60529) and at the same time strain-relieved according to DIN EN 62444. Up to 48 cables can be routed and a very high cable density achieved by using multiple grommets.

The basic triangular shape provides maximum space for cable entry. This allows the use of cables with different bending radii.

The distribution box fits standard metric cut-outs M32 – M75 and is secured with a locknut which is included in the delivery. The screw-on cover and the use of split cable grommets make it easy to retrofit or service at a later date.

Advantages

- Fast and easy assembly
- Easy distribution of cables in a 360° angle
- Warranty on pre-terminated cables remains
- Retrofittings, repairs and maintenance can be done much more easily and quickly
- Suitable for metric cut-outs M32 – M75
- Strain relief according to EN 62444
- Use of the proven KT grommet system
- High cable density, wide variety of grommets
- High flexibility with the use of multi-range and IMAS-CONNECT™ adapter grommets
- Hexagonal locknut included in the delivery
- High stability, vibration resistant
- Mechanical protection of the central entry point
- Captive screws

Specifications

Material	Polyamide (PA)
Flame class	UL 94 V-0, self-extinguishing
IP rating	IP54 (certified acc. to EN 60529)
Temperature	-40°C to +140°C (static)
Properties	Halogen-free, silicone-free
Frame depth	39,4 mm

Accessories

KT cable grommets	66-81
IMAS-CONNECT adapter grommets	82-91

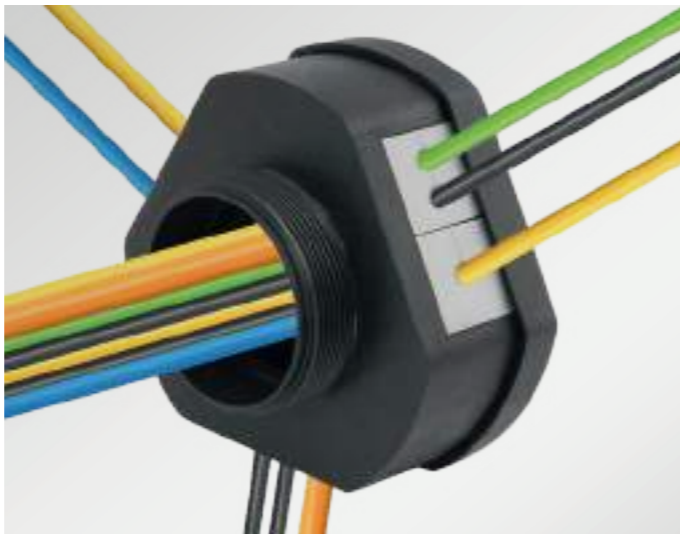

DB Distribution Box
360° cable entry

1.13



IP54

Type	Grommets small	For max. no. of cables	Cut-out	Thread length	Dimensions L x B	Mounting height	Order No.	PU
DB 3x1 M32	3	12	M32	13,6 mm	72 x 67 mm	39,4 mm	54300	5
DB 3x2 M50	6	24	M50	13,6 mm	94,5 x 87 mm	39,4 mm	54301	5
DB 3x3 M63	9	36	M63	13,6 mm	115 x 104 mm	39,4 mm	54302	1
DB 3x4 M75	12	48	M75	13,6 mm	140 x 125 mm	39,4 mm	54303	1

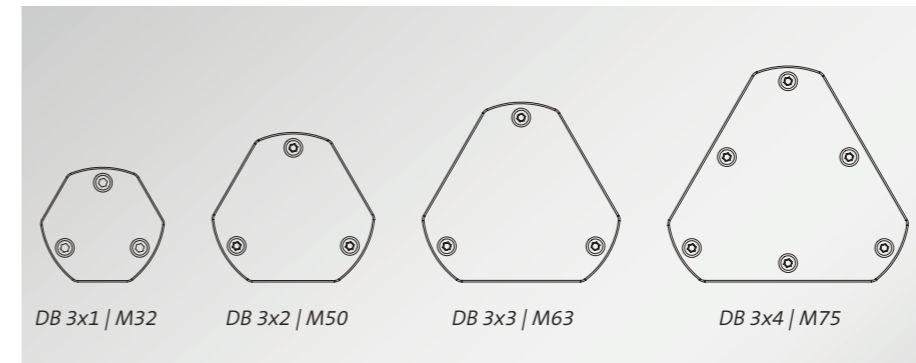

1.14 Cable grommets for the KT system

1.14



Cable grommets KT are used with the following cable entry components:

- KEL cable entry frames
- KVT split cable glands

In combination with KEL-ER cable entry frames and KVT-ER cable glands the KT single-hole grommets enable a sealing of the cables with up to IP66/IP68 and UL Type 4X.

In principle, there are two types of cable grommets: split and non-split grommets. The split grommets are suitable for routing cables with connectors, the non-split ones are used for routing non-terminated cables.

Electrical, pneumatic or hydraulic lines as well as corrugated conduits and hoses can be easily routed, sealed and strain relieved using split cable entry systems.



Overview of cable entry systems and matching grommets

Product	Split cable grommets for cables with connectors				Non-split cable grommets for cables without connectors			
	KT small single-hole	KT large single-hole	KT small multi, special	KTMB multi-range	KT-DPF multi-range	KT-SC multi-range	KTMB multi-range	KT-DT
KEL-ER	■	■	■	■	■	■	■	■
KEL-U	■	■	■	■	■	■	■	■
KEL-FA	■	■	■	■	■	■	■	■
KEL	■	■	■	■	■	■	■	■
KEL-FG-ER	■	■	■	■	■	■	■	■
KEL-FG	■	■	■	■	■	■	■	■
KEL-FW	■	■	■	■	■	■	■	■
KVT-ER	■	■	■	■	■	■	■	■
KVT	■	■	■	■	■	■	■	■
KVT 80	■	■	■	■	■	■	■	■
KVT-SNAP	■	■	■	■	■	■	■	■
KVT W90	■	■	■	■	■	■	■	■
DB	■	-	■	■	■	■	■	■

■ Not recommended, as the degree of protection would be reduced to IP54

Split cable grommets for cables with connectors



Split cable grommets, single
Protection up to IP66/IP68 and UL Type 4X for cable diameters 1 to 35 mm
KT
68 – 69

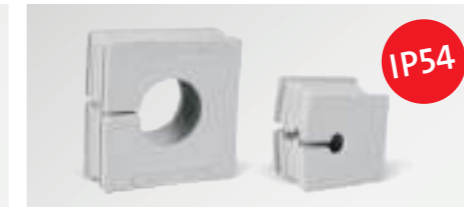

Split multi-range cable grommets
IP54 protection and UL Type 12 for cable diameters 4 to 29 mm
KTMB
70 – 71



Split cable grommets, multi and special
IP54 protection and UL Type 12 for cable diameters 1 to 8 mm
KT multi
72

Non-split cable grommets for cables without connectors



Multi-range cable grommets
IP54 protection for cable diameters 3 to 26 mm
KT-DPF
73



Multi-range cable grommets
IP54 protection for cable diameters 4 to 28 mm
KT-SC
74



Multi-range cable grommets
IP54 protection for cable diameters 2.5 to 33 mm
KTMB
75



Membrane cable grommets
IP54 protection, high cable density for cable diameters up to 14.5 mm
KT-DT
76



Plugs and cover plugs
Plugs for cable grommets, Cover plugs for cable entry frames
77 – 78



Plugs for membranes
ST-B
151



KT Servicebox
Service box for cable grommets
79



IMAS-CONNECT™
Modular adapter system for the KT system
82 – 91

1.14

KT

Split cable grommets, small, single

IP54 IP66 IP68



Split cable grommets KT are used with the following cable entry components:

- KEL cable entry frames
- KVT split cable glands

They are designed for cable diameters from 1 to 17 mm. Blank grommets can seal unused grommet spaces.

When installing the small grommets in multiple rows, the flat sides should be facing each other. This allows the flat sides to match up and provide a secure seal.

Advantages

- Routing of cables with and without connectors
- High degree of protection up to IP68
- High strain relief in accordance with EN 62444 when a suitable cable entry is selected
- Available for a wide range of cable diameters

Specifications KT grey

Material	Elastomer
Flame class	UL 94 V-o, self-extinguishing
IP rating	up to IP66/IP68
UL type rating	up to UL type 4X (acc. to UL 50E)
Temperature	-40°C to +100°C (static)
Properties	Halogen-free, silicone-free

Specifications KT black

Material	Elastomer
Flame class	UL 94 HB
IP rating	up to IP66/IP68
Temperature	-30°C to +90°C (static)
Properties	Silicone-free Higher chemical resistance e.g. with aggressive oils, coolants

Accessories

ST Plugs 77



*Only valid for grey product types | **4X for indoor use only

KT

Split cable grommets, large, single

IP54 IP66 IP68

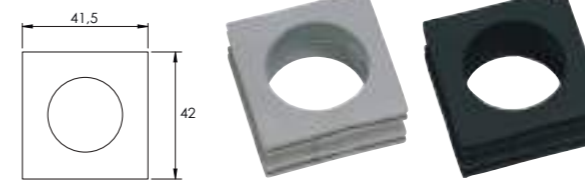

Split cable grommets KT are used with the following cable entry components:

- KEL cable entry frames
- KVT split cable glands

They are designed for cable diameters from 13 to 35 mm.

The adapter grommet ATG offers the possibility to accommodate a small cable grommet KT and thus reduce the clamping range down to 1 mm.

Advantages

- Routing of cables with and without connectors
- High degree of protection up to IP68
- High strain relief in accordance with EN 62444 when a suitable cable entry is selected
- Available for a wide range of cable diameters

Specifications KT grey

Material	Elastomer
Flame class	UL 94 V-o, self-extinguishing
IP rating	KT round, single: up to IP66/IP68 ATG/BTG: IP54
UL type rating	up to UL type 4X (acc. to UL 50E)
Temperature	-40°C to +100°C (static)
Properties	Halogen-free, silicone-free

Specifications KT black

Material	Elastomer
Flame class	UL94-HB
IP rating	KT round, single: up to IP66/IP68 ATG/BTG: IP54
Temperature	-30°C to +90°C (static)
Properties	Silicone-free Higher chemical resistance e.g. with aggressive oils, coolants

Accessories

ST Plugs 77

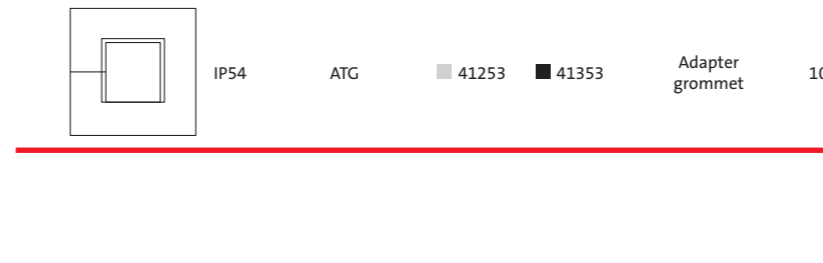

*Only valid for grey product types | **4X for indoor use only

KTMB5

Split multi-range grommets, small

KTMB5

Split multi-range grommets, large

1.14

IP54



Cable grommets KTMB5 are used to route cables with and without connectors with the following cable entry components:

- KEL cable entry frames (KEL-U, KEL, KEL-FA, KEL-FG)
- KVT cable glands

The innovative membrane enables the routing of cables with diameters that can vary up to 3 mm.

The KTMB5 small allows for the routing of cable diameters from 4 to 12 mm.

The innovative wave cut and the flexible sealing lips make it possible to seal the cable with IP54/UL Type 12.

Advantages

- Routing of cables with and without connectors
- IP rating IP54
- Strain relief when a suitable cable entry is selected
- Large clamping range
- Only 4 grommets cover a clamping range from 4 to 12 mm
- Innovative wave cut for a better sealing
- Innovative membrane for high flexibility

Specifications

Material	Elastomer
Flame class	UL94-Vo, self-extinguishing
IP rating	IP54
Temperature	-40°C to +100°C (static)
Properties	Silicone free, halogen free



i ST-B plug for the sealing of the perforated membrane



Detail of the wave cut

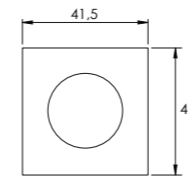

Description	Type	Order No	Clamping range	PU
-------------	------	----------	----------------	----

	KTMB5 12-15	41384	12 – 15 mm	10
	KTMB5 14-17	41385	14 – 17 mm	10
	KTMB5 16-19	41386	16 – 19 mm	10
	KTMB5 18-21	41387	18 – 21 mm	10
	KTMB5 20-23	41388	20 – 23 mm	10
	KTMB5 22-25	41389	22 – 25 mm	10
	KTMB5 24-27	41390	24 – 27 mm	10
	KTMB5 26-29	41391	26 – 29 mm	10

16 mm cable

19 mm cable

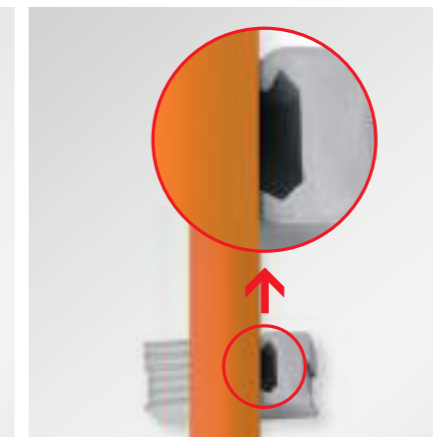
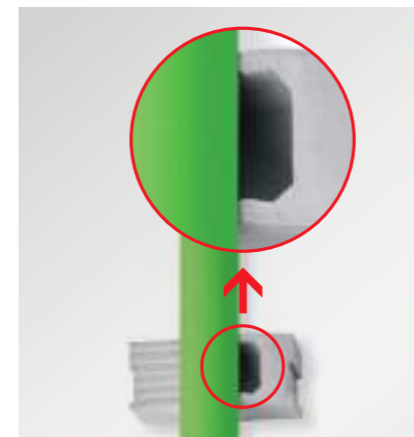

IP54

Cable grommets KTMB5 are used to route cables with and without connectors with the following cable entry components:

- KEL cable entry frames (KEL-U, KEL, KEL-FA, KEL-FG)
- KVT cable glands

The innovative membrane enables the routing of cables with diameters that can vary up to 3 mm.

The KTMB5 large allows for the routing of cable diameters from 12 to 29 mm.

The innovative wave cut and the flexible sealing lips make it possible to seal the cable with IP54/UL Type 12.

Advantages

- Routing of cables with and without connectors
- IP54 rating
- Strain relief when a suitable cable entry is selected
- Large clamping range
- Only 8 grommets cover a clamping range from 12 to 29 mm
- Innovative wave cut for a better sealing
- Innovative membrane for high flexibility

Specifications

Material	Elastomer
Flame class	UL94-Vo, self-extinguishing
IP rating	IP54
Temperature	-40°C to +100°C (static)
Properties	Silicone free, halogen free

1.14

KT

Split cable grommets, small, multi and special

KT-DPF

Multi-range cable grommets, in pyramid shape, non-split

1.14



Description	Type	Order No grey	Order No black	Clamping range	PU
	KT 2 1	39942	39944	2x ø 1 mm	10
	KT 2 2	39935	39936	2x ø 2 mm	10
	KT 2 3	39939	39940	2x ø 3 mm	10
	KT 2 4	39906	39907	2x ø 4 mm	10
	KT 2 5	41200	39904	2x ø 5 mm	10
	KT 2 6	41201	39905	2x ø 6 mm	10
	KT 2 7	41202	39916	2x ø 7 mm	10
	KT 2 8	39917	39918	2x ø 8 mm	10
	KT 4 2	39937	39938	4x ø 2 mm	10
	KT 4 3	39914	39915	4x ø 3 mm	10
	KT 4 4	39909	39911	4x ø 4 mm	10
	KT 4 5	39908	39910	4x ø 5 mm	10
	KT 4 6	39932	39933	4x ø 6 mm	10
		KT ASI	39902	39903	1 ASI-cable
KT-ASI2 rl		39922	39924	2 ASI-cables	10
KT-ASI2 lll		39921	39923	2 ASI-cables	10
	KT oval	39930	-	approx. 8 x 4 mm	10
	KT S1	39931	-		10
	KT tele	39929	-	Telephone cable	10
	KT tele1	41257	-	Data cable RJ12	10
	KT tele2	41258	-	Data cable RJ10 / RJ45	10

Split cable grommets KT are used with the following cable entry components:

- KEL cable entry frames
- KVT split cable glands

KT multi-hole and special grommets enable a sealing of the cables with IP54 and UL Type 12.

When using double or quadruple grommets the cable density of cable entry frames and cable glands can be greatly increased. The multi-hole model range KT small is designed for cable diameters from 1 to 8 mm. icotek also offers special cable grommets for e.g. ASI lines. ATG adapter grommets provide the possibility to hold a small KT grommet to reduce the clamping range down to 1 mm.

When installing the small grommets in multiple rows, the flat sides should be facing each other. This allows the flat sides to match up and provide a secure seal.

Advantages

- Routing of pre-assembled cables through cable entry frames and split cable glands
- IP rating IP54
- Greatly increased cable density when using double or quadruple grommets
- High strain relief in accordance with EN 62444 when a suitable cable entry is selected
- Available for a wide range of cable diameters

Specifications KT grey

Material: Elastomer
 Flame class: UL 94 V-o, self-extinguishing
 IP rating: IP54
 UL type rating: up to UL type 12 (acc. to UL 50E)
 Temperature: -40°C to +100°C (static)
 Properties: Halogen-free, silicone-free

Specifications KT black

Material: Elastomer
 Flame class: UL 94 HB
 IP rating: IP54
 Temperature: -30°C to +90°C (static)
 Properties: Silicone-free
 Higher chemical resistance e.g. with aggressive oils, coolants

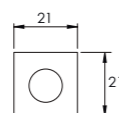

*Only valid for grey product types

1.14



Description	Type	Order No	Size KT	Clamping range	PU
	KT-DPF-A	41260	KT small	3 – 12 mm	10
		41360			
	KT-DPF-B	41261	KT large	4 – 18 mm	10
		41361			
	KT-DPF-C	41262	KT large	14 – 26 mm	10
		41362			



The multi-range KT-DPF grommets accept a wide range of cable diameters. A great benefit when the exact cable diameter is not known in advance. Due to the flexibility and unique pyramid shape, routing and flexible positioning of rigid cables is much easier compared to using conventional cable glands. It is recommended that additional strain relief be provided for the cables using a cable tie.

The KT-DPF small allows for the routing of cable diameters from 3 to 12 mm, the KT-DPF for diameters from 4 to 26 mm.

The KT-DPF grommets are not split and therefore only usable for cables without connectors.

Cutting of KT-DPF grommets: Cable diameter less 20%.

Advantages

- Routing of cables without connectors through cable entry frames and split cable glands
- IP rating IP54
- High strain relief when a suitable cable entry is selected
- Large clamping range
- Only 3 grommets cover a clamping range from 3 to 26 mm
- Flexible even with rigid cables
- Ideal for wiring non pre-terminated cables locally
- Easy storage

Specifications grey

Material: Elastomer
 Flame class: UL 94 V-o, self-extinguishing
 IP rating: IP54
 UL type rating: UL type 12 (acc. to UL 50E)
 Temperature: -40°C to +100°C (static)
 Properties: Halogen-free, silicone-free

Specifications black

Material: Elastomer
 Flame class: UL94-HB
 IP rating: IP54
 Temperature: -30°C to +90°C (static)
 Properties: Silicone-free
 Higher chemical resistance e.g. with aggressive oils, coolants

KMS Cable template

Page 79
Order No. 39800

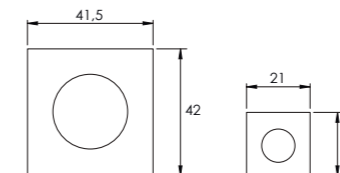

*Only valid for grey product types

KT-SC

Multi-range cable grommets, non-split



The KT-SC grommets accept a wide range of cable diameters. This is a great benefit when the exact cable diameter is not known in advance.

The single circular membrane can be peeled away to accommodate the specific diameter of the cable or hose. For this purpose, only a small hole between the rings needs to be pierced. Then the corresponding ring can be removed. The peeled-off area is always round, ensuring a secure seal around cable/hose.

The KT-SC cable grommet is based on the KT grommet and enables flexible routing and sealing (IP54) of electrical cables and pneumatic hoses with diameters from 4 to 28 mm.

The KT-SC cable grommets are not split and therefore only usable for cables without connectors. However, it is possible to feed through cables with a pre-mounted cable lug.

Advantages

- Routing of cables without connectors through cable entry frames and split cable glands
- IP rating IP54
- Large clamping range
- Circular membranes can be peeled off easily
- Flexible even with rigid cables
- Ideal for wiring non pre-terminated cables locally
- Easy storage

Specifications

Material	Elastomer
Flame class	UL 94 V-0, self-extinguishing
IP rating	IP54
UL type rating	UL type 12 (acc. to UL 50E)
Temperature	-40°C to +100°C (static)
Properties	Halogen-free, silicone-free

Description	Type	Order No.	Size KT	Clamping range	PU
	KT-SC small	41490	KT small	4 – 12 mm	10
	KT-SC large	41485	KT large	5 – 28 mm	10



KMS Cable template

Page 79
Order No. 39800

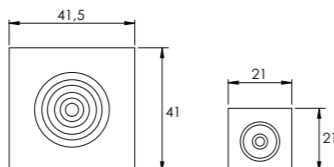

KTMB

Multi-range cable grommets, non-split



The KTMB grommets accept a wide range of cable diameters. A great benefit when the exact cable diameter is not known in advance.

The KTMB grommets are not split and therefore only usable for cables without connectors.

The model range KTMB small covers a diameter range from 2.5 to 16 mm, the model range KTMB large covers a diameter range from 13 to 33 mm.

Advantages

- Routing of cables without connectors through cable entry frames and split cable glands
- IP rating IP54
- Ideal for wiring non pre-terminated cables locally
- Easy storage

Specifications

Material	Elastomer
Flame class	UL 94 V-0, self-extinguishing
IP rating	IP54
UL type rating	UL type 12 (acc. to UL 50E)
Temperature	-40°C to +100°C (static)
Properties	Halogen-free, silicone-free

Description	Type	Order No.	Size KT	Clamping range	PU
	KTMB-A	41432	KT small	2.5 – 6.5 mm	10
	KTMB-B	41434	KT small	4 – 7.5 mm	10
	KTMB-C	41436	KT small	6.5 – 10 mm	10
	KTMB-D	41438	KT small	9.5 – 13 mm	10
	KTMB-E	41440	KT small	13 – 16 mm	10
	KTMB-G	41460	KT large	13 – 18 mm	10
	KTMB-H	41465	KT large	18 – 23 mm	10
	KTMB-I	41470	KT large	23 – 28 mm	10
	KTMB-J	41475	KT large	28 – 33 mm	10
	KTMB-K	41480	KT large	2x 13 – 18 mm	10



Cross section KTMB

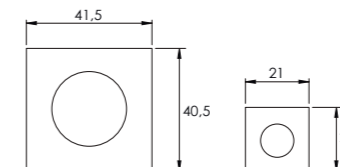

KT-DT

Membrane cable grommets, non-split

ST

Plugs for cable grommets

1.14

IP54

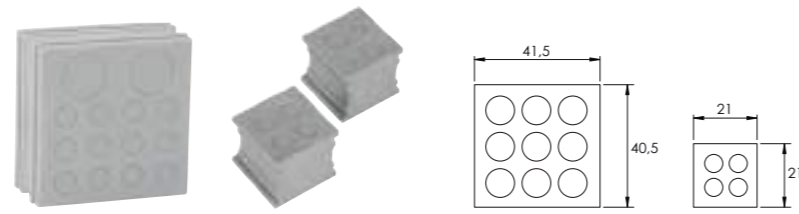

The KT-DT cable grommets can be used anywhere where a large number of electrical, pneumatic or hydraulic lines must be routed and sealed with IP54. By using the KT-DT grommets, the cable density can be significantly increased.

KT-DT grommets are compatible with split cable entry frames, such as KEL-U, KEL and KEL-FG. The routing of cables with and without preassembled connectors in one cable entry frame can thus be easily combined.

KT-DT 1 – KT-DT 5 grommets are designed to fit in KT large grommet spaces. KT-DT 7 and KT-DT 8 grommets are designed to fit in KT small grommet spaces.

The KT-DT grommets are also perfectly suitable for the assembly of subsequently terminated cable harnesses.

Advantages

- Combination of routing pre-terminated cables and cables without connectors with one cable entry frame
- IP54 rating
- High cable density
- Enables sub-assembly of cable harnesses

Specifications

Material	Elastomer
Flame class	UL 94 V-0, self-extinguishing
IP rating	IP54
UL type rating	UL type 12 (acc. to UL 50E)
Temperature	-40°C to +100°C (static)
Properties	Halogen-free, silicone-free

Accessories

ST-B Plugs 151

Description	Type	Order No.	Number of cables	PU
	KT-DT 1	41500	12× max. 6.5 mm 2× max. 12.2 mm	10
	KT-DT 2	41510	16× max. 7.1 mm	10
	KT-DT 3	41520	4× max. 6.5 mm 3× max. 9.5 mm 3× max. 11.3 mm	10
	KT-DT 4	41530	9× max. 9.5 mm	10
	KT-DT 5	41540	4× max. 14.5 mm 1× max. 9.5 mm	10
	KT-DT 7	41550	4× max. 6 mm	10
	KT-DT 8	41552	2× max. 7 mm 2× max. 4 mm	10



Description	Type	Order No.	Diameter D	Length L	PU
	ST 1	42900	1 mm	25 mm	25
	ST 2	42909	2 mm	25 mm	25
	ST 3	42901	3 mm	25 mm	25
	ST 4	42908	4 mm	25 mm	25
	ST 5	42906	5 mm	25 mm	25
	ST 6	42903	6 mm	25 mm	25
	ST 7	42905	7 mm	25 mm	25
	ST 8	42899	8 mm	20 mm	25
	ST 9	42897	9 mm	20 mm	25
	ST 10	42895	10 mm	20 mm	25
	ST 11	42893	11 mm	20 mm	25
	ST 12	42891	12 mm	20 mm	25
	ST 13	42889	13 mm	20 mm	25
	ST 14	42887	14 mm	20 mm	25
	ST 15	42885	15 mm	20 mm	25
	ST 16	42883	16 mm	20 mm	25
	ST 17	42881	17 mm	20 mm	25
	ST ASI	42877	–	25 mm	25

Plugs are used to close either KT or QT grommets which are not equipped with cables. IP ratings of the grommets remain.

Perfect for applications where cables have been removed or might be routed at a later stage.

Advantages & benefits

- Sealing unused cable grommets

Specifications

Material	Polyamide (PA), white
Flame class	UL 94 V-0, self-extinguishing
IP rating	IP rating of grommets remains
UL type rating	UL type 12 (acc. to UL 50E)
Temperature	-40°C to +120°C
Properties	Halogen-free, silicone-free

Compatible with

KT Cable grommets 66 - 91
QT Cable grommets 106 - 111



Cover plugs for cable entry frames



The openings at the fastening points of the cable entry frames can be closed with the cover plugs.

There are two versions: One version to cover the openings when using threaded bushings, one to cover the screws. The cover plugs can be used with the products of the KEL series.

Advantages

- Simple closing of the openings at the fastening points of the KEL
- Smooth finish on the frame surface
- No dirt recesses

Specifications

Material	Polyethylene (PE)
Temperature	Continuous operating temperature +70°C
Properties	Higher chemical resistance

Description	Order No.	PU
Cover plugs A black for threaded bushings, for KEL	■ 99142	100
Cover plugs B black for M5 DIN 912 Screws, for KEL	■ 99200	40



When fastening from the rear using a threaded bushing, an opening is created at the front at the fastening points. These can be closed with the **cover plugs A** in black (Order No. 99142).

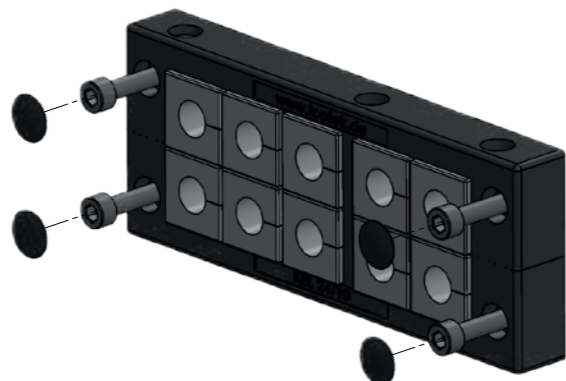

When fastening from the front by means of screws, the openings at the screw heads can be closed with the **cover plugs B** in black (order no. 99200). The cover plugs can only be used for M5 DIN 912 screws.



KT ServiceBox Service box for cable grommets

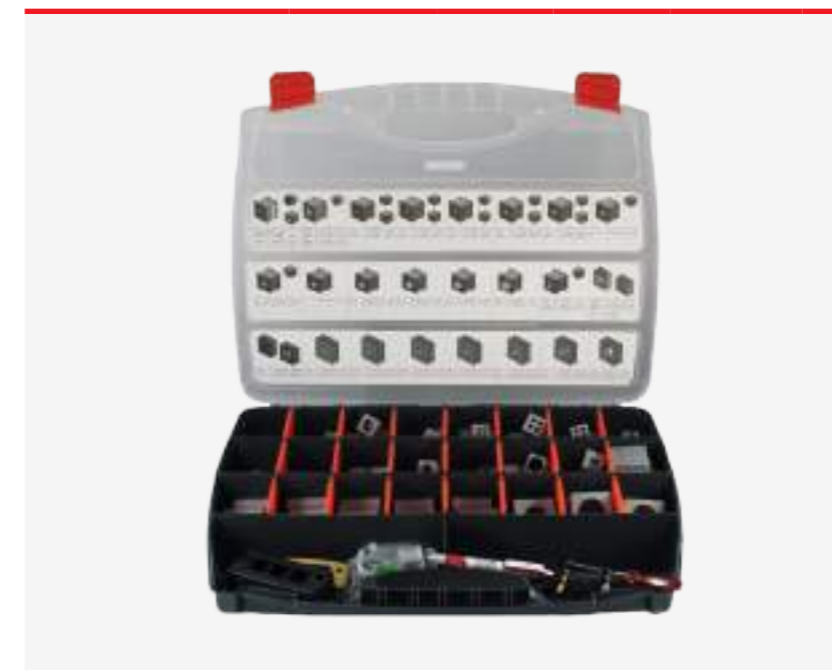

KMS Cable template



The correct size of the KT grommets can easily be determined by using the cable template (material: stainless steel V2A).

- Determining the diameter of the cable using the cable template
- Selecting the KT grommets according to the data on the cable template

Cable templates can also be ordered separately. **Order-No. 39800**

Convenient – everything available right away!

The KT ServiceBox is perfect for installations and service calls. It ensures your KT grommets are readily available.

Order No. 88001

Content*

Cable grommets, small:

- 110 KT for cables 1 - 17 mm
- 10 BTK blank grommets
- 10 KTMB multi-range grommets
- 2 KT-DPF multi-range grommets
- 8 KT-ASI for ASI-Bus cables
- 1 AT-K-M 12x1.5

Cable grommets, large:

- 25 KT for cables 16 - 35 mm
- 4 BTG blank grommets / ATG adapter grommets
- 3 KTMB multi-range grommets
- 2 KT-DT multi-membrane grommets
- 2 KT-DPF multi-range grommets
- 2 KT-SC
- 2 AT-M 12x1.0

Accessories:

- 1 Cable entry frame KEL-U 10|3
- 1 Cable entry frame KEL-E3
- 1 KVT split cable gland
- 1 KZL strain relief plate

- 1 Cable template

* Subject to alterations



Compile your own ServiceBox? Now it's easy with the grommet box configurator!

No more searching in vain for the right grommet: Now the assortment cases for different types and sizes of cable grommets of the KT or the QT series can be configured individually. So the perfect grommets are always at hand.

Start the configurator: www.icotek.com/en/config/626044



The practical product configurator

With the product configurator, you can now assemble your cable entry system with the required cable or adapter grommets.

Check it out: www.icotek.com/en/config

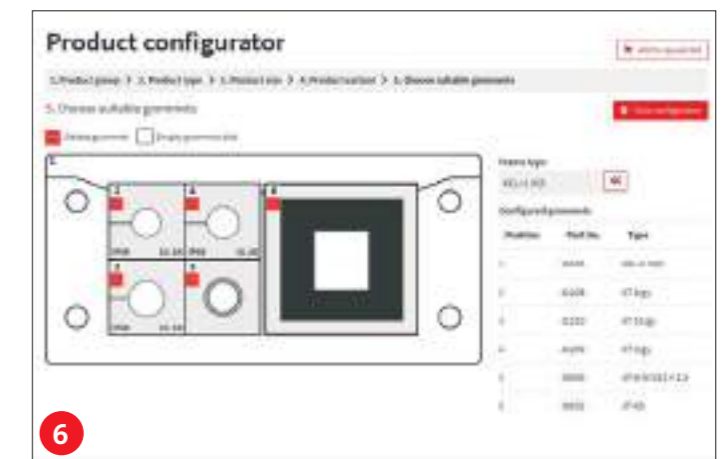
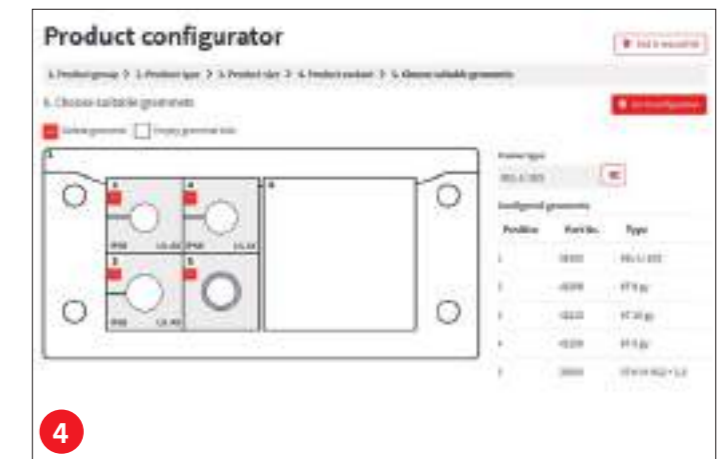
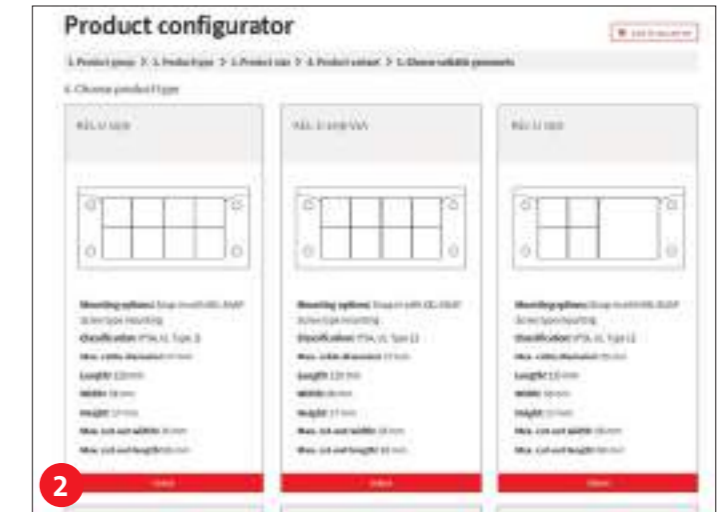

1.15 Modular adapter system

IMAS-CONNECT™ for the KT system



1.15

Simply configure the most individual cable entry in the world

The IMAS-CONNECT™ adapter system is a modular designed grommet system for mounting metric connectors, PushPull modules, Keystone couplers, hose fittings, pressure compensation elements and much more.

By utilising the modular adapter system, the cable entry frame becomes a hybrid system. Pre-terminated and standard cables or hoses can be rout-

ed. At the same time the system serves as a unique interface for all kinds of connectors. This means that only one interface or cut-out is required for various cables and connections.

The grommets, made of elastomer with a polyamide body, fit perfectly into the icotek cable entry frames e.g. KEL-U, KEL-ER, KEL-FG and meet the protection classes IP54 to IP66.

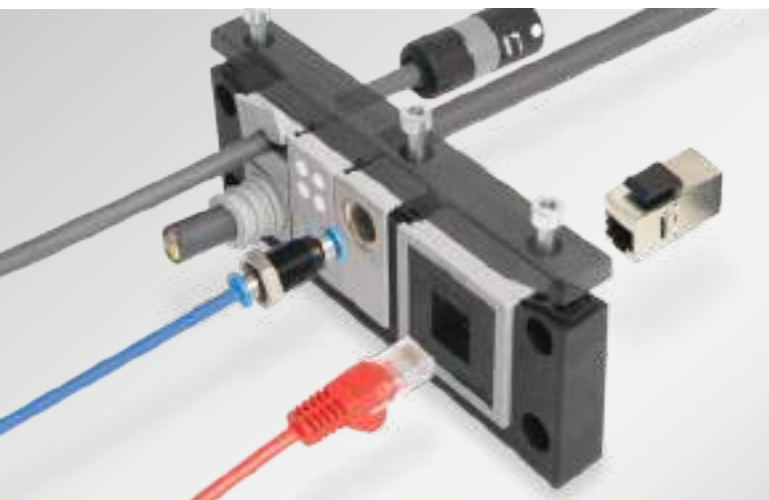

Available with pre-terminated cut-out for PushPull systems (AT-PP)

New: Adapter grommet for M23 square flange (AT-FL)

Available with threaded insert (AT-K-M/AT-K-Z), based on the KT cable grommet

Perfect integration into the split icotek cable entry frames

At a high cable density only one cut-out is necessary

Elastomer grommet with polyamide body based on the grommet KT large

High protection class: up to IP66

Available with metric inner threads of M12 x 1.0, M16 x 1.5, M20 x 1.5, M25 x 1.5 (AT-M).

Usable area for special cut-outs and drill-holes: 24 x 24 mm; Wall thickness: 6 mm (AT-B)

Available with pre-terminated cut-out for Keystone couplers (AT-KS)

 <p>Adapter grommet, large for M23 square flange AT-FL 84</p>	 <p>Adapter grommet, large for PushPull connector systems AT-PP 85</p>	 <p>Adapter grommet, large for Keystone couplers AT-KS 86</p>
 <p>Adapter grommet, small with threaded insert AT-K-M AT-K-Z 87</p>	 <p>Adapter grommet, large with metric inner thread AT-M 88</p>	 <p>Adapter grommet, blank, large AT-B 88</p>
 <p>Pressure compensation element with metric thread PCE 89</p>	 <p>Adapter grommet, large with mounted Keystone modules or bulkhead couplings, product set 90</p>	 <p>Keystone modules, single, bulkhead couplings and accessories 91</p>

Various application examples

USB, RJ45, HDMI and approx. 70 other Keystone couplers.

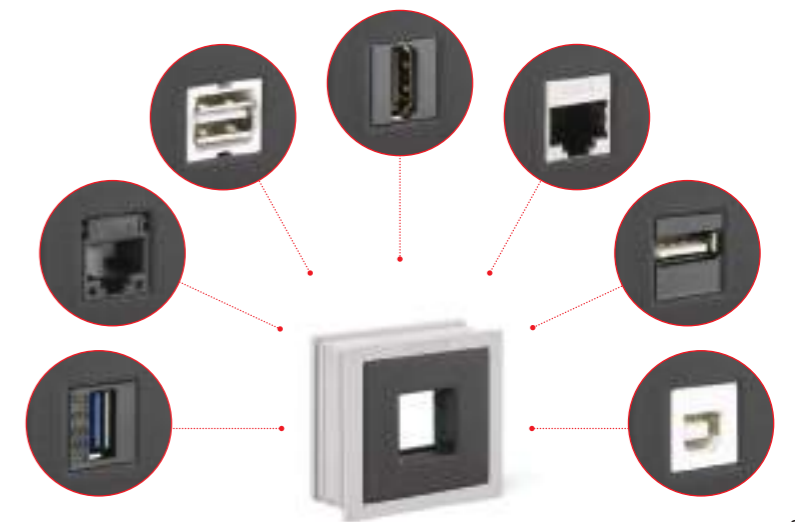

AT-FL

Adapter grommet, large for M23 square flange



Type	Order No.	Height x width x length [mm]	Material	PU
AT-FL	39965	42 x 41.5 x 19	PA/Elastomer	5

The grommet AT-FL is constructed on the basis of a large KT cable grommet. The polyamide body is moulded with elastomer. All square flanges with dimensions 19.8 x 19.8 mm (M23) can be integrated.

The insertion of AT-FL into an icotek cable entry frame enables the routing of cables with and without connectors in combination with the creation of interfaces for M23 connectors within one cable entry system. Separate cut-outs for connectors are no longer necessary.

AT-FL provides ingress protection of up to IP65 (depending on the used flange and connector).

Advantages & benefits

- By using the AT-FL grommet, connectors can be integrated directly into the cable entry frame
- Separate cut-outs for connectors are no longer necessary
- Space-saving solution
- Cost-saving assembly

Specifications

Material	Grommet: Elastomer Body: Polyamide
Flame class	UL 94 V-0, self-extinguishing
Protection class	IP54, IP55, IP64, IP65
Temperature	-40°C to +90°C (static)
Properties	Halogen free, silicone free

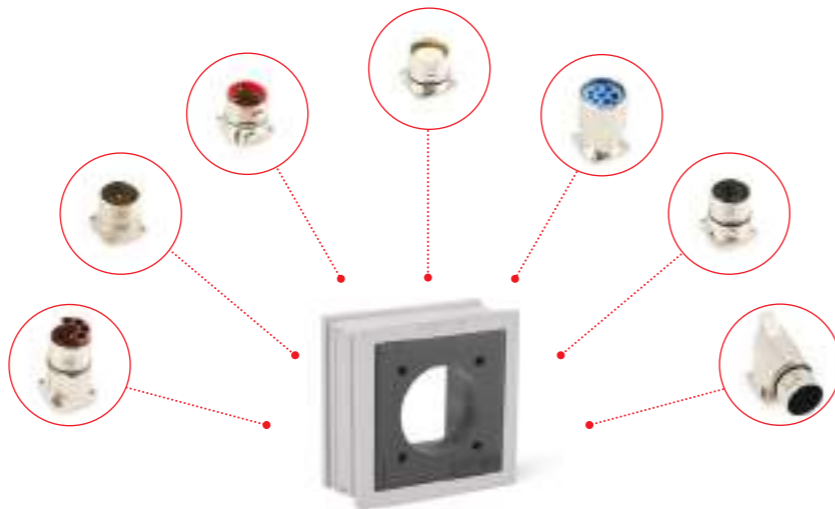

AT-PP

Adapter grommet, large for PushPull connector systems



Type	Order No.	Height x width x length [mm]	Material	PU
AT-PP	39961	42 x 41.5 x 19	PA/Elastomer	5

The grommet AT-PP is constructed on the basis of a large KT cable grommet. In this elastomer grommet, a polyamide body is integrated. All modules based on the PushPull system can be inserted into the grommet.

By using the grommet AT-PP, the split cable entry frame can be used to route pre-terminated cables and at the same time it can also be used as an interface for connectors. This can save additional cut-outs and reduce labour costs.

PushPull modules and add-on housings are not included in the scope of delivery.

Advantages & benefits

- By using AT-PP grommets, panel connectors and sockets can be integrated directly into the cable entry system
- Separate cut-outs for connectors are no longer necessary
- Time saving solution
- Space-saving solution
- Assembly costs are reduced

Specifications

Material	Grommet: Elastomer Body with thread: Polyamide
Flame class	UL 94 V-0, self-extinguishing
Protection class	IP65 when using correct components
Temperature	-40°C to +100°C (static)
Properties	Halogen free, silicone free



The module (left) snaps into the rear of the add-on housing mounted on the AT-PP



AT-KS

Adapter grommet, large for Keystone couplers

IP54



Type	Order No.	Height x Width x Length [mm]	Material	PU
AT-KS	39952	42 x 41.5 x 19	PA/Elastomer	10

Type	Order No.	Height x Width x Length [mm]	Colour Keystone module	PU
AT-KS-USB 3.0	39968	42 x 41.5 x 19	black	1
AT-KS-HDMI	39969	42 x 41.5 x 19	black	1
AT-KS-CAT6	39970	42 x 41.5 x 19	silver	1

The grommet AT-KS is constructed on the basis of a KT cable grommet. In this elastomer grommet, a polyamide body is integrated. All couplers based on the Keystone system can be simply snapped in.

By using the grommet AT-KS, the split cable entry frame can be used to route pre-terminated cables and at the same time it can also be used as an interface for connectors. This can save additional cut-outs and reduce labour costs.

Advantages & benefits

- By utilising the AT-KS grommet, connectors can be integrated directly into the cable entry frame
- Separate cut-outs for connectors are no longer necessary
- Space-saving solution
- Grommet is suitable for all Keystone couplers
- Snap-in assembly

Specifications

Material	Grommet: Elastomer Body: Polyamide
Flame class	UL 94 V-0, self-extinguishing
Protection class	IP54 depending on Keystone module and manufacturer
Temperature Properties	-40°C to +100°C (static) Halogen free, silicone free

Individual Keystone modules on page 91.



USB, RJ45 or e.g. HDMI connectors can be plugged in from the front and from the back



AT-K-M | AT-K-Z

Adapter grommet, small with threaded insert

IP66



Type	Order No.	Height x Width x Length [mm]	Thread	Material	PU
AT-K-M 5x0.5	39953	21 x 21 x 19	M5 x 0.5	Brass/Elastomer	5
AT-K-M 8x0.5	39966	21 x 21 x 19	M8 x 0.5	Brass/Elastomer	5
AT-K-M 8x1.0	39954	21 x 21 x 19	M8 x 1.0	Brass/Elastomer	5
AT-K-M 12x1.0	39955	21 x 21 x 19	M12 x 1.0	Brass/Elastomer	5
AT-K-M 12x1.5	39956	21 x 21 x 19	M12 x 1.5	Brass/Elastomer	5
AT-K-M 14x1.0	39962	21 x 21 x 19	M14 x 1.0	Brass/Elastomer	5
AT-K-M 16x1.5	39957	21 x 21 x 19	M16 x 1.5	Brass/Elastomer	5
AT-K-Z 1/8"	39963	21 x 21 x 19	1/8"	Brass/Elastomer	5
AT-K-Z 1/4"	39964	21 x 21 x 19	1/4"	Brass/Elastomer	5

The AT-K-M grommet is constructed on the basis of a KT cable grommet. The grommets are made of elastomer with a nickel-plated brass body. The AT-K-M grommets are available with inner threads in sizes M5 x 0.5, M8 x 0.5, M8 x 1.0, M12 x 1.0, M12 x 1.5, M14 x 1.0 and M16 x 1.5 and the AT-K-Z grommets with inner threads in sizes 1/8" and 1/4".

By using the AT-K-M adapter grommet, several connectors can be inserted directly into the cable entry frame, e.g. pneumatic bulkhead connectors M12 x 1.0 and M14 x 1.0, metric connectors and pressure compensation elements.

They are compatible with all split icotek cable entry systems that are suitable for KT cable grommets.

Advantages & benefits

- By using AT-K-M grommets, panel connectors and sockets can be integrated directly into the cable entry system
- Separate cut-outs for connectors are no longer necessary
- Space-saving solution
- Thread sizes M5 to M16 and 1/8" to 1/4" available

Specifications

Material	Grommet: Elastomer Body: nickel-plated brass
Flame class	UL 94 V-0, self-extinguishing
Protection class	IP66 when using correct components
Temperature Properties	-40°C bis +100°C (static) Halogen free, silicone free

KEL-U 183-E16 mounted with 16x AT-K-M 12x1.5, equipped with 16x bulkhead couplings



AT-K-M with extension M16x1.5 for M12 built-in connectors

AT-M | AT-B

Adapter grommet, large with metric inner thread

IP65



Type	Order No.	Height x width x length [mm]	Thread	Material	PU
AT-M 12x1.0	39946	42 x 41.5 x 19	M12 x 1.0	PA/Elastomer	10
AT-M 16x1.5	39947	42 x 41.5 x 19	M16 x 1.5	PA/Elastomer	10
AT-M 20x1.5	39948	42 x 41.5 x 19	M20 x 1.5	PA/Elastomer	10
AT-M 25x1.5	39949	42 x 41.5 x 19	M25 x 1.5	PA/Elastomer	10
AT-B blank	39950	42 x 41.5 x 19	-	PA/Elastomer	10

Screw plugs for AT-M

Type	Order No.	Thread	Material	PU
Screw plug M16 x 1.5	99195	M16	Polyamide	10
Screw plug M20 x 1.5	99196	M20	Polyamide	10
Screw plug M25 x 1.5	99197	M25	Polyamide	10



KEL-U 24/7 mounted with 1x AT-M, equipped with 1 connector M12x1.0, for the connection of sensors



KEL 24/21-2 MT mounted with 3x AT-M, equipped with M16 circular connector, M12 pressure compensation element and a hybrid connector

1.15

AT-M is a grommet (based on large KT grommets) with integrated metric threads, suitable for split icotek cable entry systems. The AT-M grommets are made of elastomer with a polyamide body. AT-M grommets are available with inner threads in sizes M12x1.0, M16x1.5, M20x1.5 and M25x1.5.

The AT-M is ideal for creating an interface for signal, data, power and hybrid connectors by simply screwing them into the AT-M thread. Pressure compensation elements or conduit connectors up to M25x1.5 can also be screwed into the AT-M.

icotek also offers screw plugs for sizes M16, M20 and M25 to close the new adapter grommet with the metric internal thread AT-M.

There is also a blank AT-B grommet available. The integrated polyamide body is completely closed on one side. The effective area is 24 x 24 mm, the wall thickness is 6 mm. Custom drill-holes and cut-outs can be made here for e.g. installation of screw mounted hybrid connectors.

Advantages & benefits

- By using AT-M grommets, panel connectors and sockets can be integrated directly into the cable entry system
- Separate cut-outs for connectors are no longer necessary
- Space-saving solution
- Thread sizes M12 to M25 available
- Blank grommet for flexible use

Specifications

Material	Grommet: Elastomer Body with thread: Polyamide
Flame class	UL94-V0, self-extinguishing
Protection class	IP65 when using correct components
Temperature	-40°C to +100°C (static)
Properties	Halogen free, silicone free

PCE M12 x 1.5

Pressure compensation element with metric thread

IP68

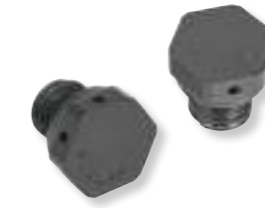

Type	Order No.	Thread	PU
PCE M12 x 1.5	99190	M12 x 1.5	10

The pressure compensation element PCE with M12 x 1.5 thread is used to avoid variations in pressure caused by differences in temperature and thus to prevent damage caused by condensation. It provides protection class IP68. The pressure compensation element is easy to install by screwing it directly into the enclosure wall or via adapter grommets AT-K-M 12x1.5.

Specifications

Material	Polyamide
Flame class	UL 94 V-2
Protection class	IP67, IP68
Temperature	-20°C to +100°C

1.15



KEL 24/21-2 MT equipped with M12 pressure compensation element



KVT-ER 63/4 equipped with pressure compensation element

Adapter grommet

with mounted Keystone modules or bulkhead couplings, product set



The adapter grommets type AT-KS are also supplied with pre-assembled keystone modules, type AT-K-M with bulkhead couplings.

Advantages & benefits

- By utilising the AT-KS grommet, connectors can be integrated directly into the cable entry frame
- Separate cut-outs for connectors are no longer necessary
- Space-saving solution
- Keystone modules or bulkhead couplings are already pre-assembled

Specifications

Material	Grommet: Elastomer Body: Polyamide Bulkhead coupling: Brass nickel plated
Flame class	UL 94 V-0, self-extinguishing
Protection class	IP54 depending on Keystone module and manufacturer
Temperature Properties	-40°C to +100°C (static) Halogen free, silicone free

Type	Order No.	Height x Width x Length [mm]	Colour Keystone module	PU
AT-KS-USB 3.0	39968	42 x 41.5 x 19	black	1
AT-KS-HDMI	39969	42 x 41.5 x 19	black	1
AT-KS-CAT6	39970	42 x 41.5 x 19	silver	1

Type	Order No.	Height x Width x Length [mm]	suitable for pneumatic hose	PU
AT-K-M 12x1,0 with bulkhead coupling	39971	21 x 21 x 19	4 mm	1
AT-K-M 14x1,0 with bulkhead coupling	39972	21 x 21 x 19	6 mm	1



Keystone modules

Type	Order No.	Colour	PU
Keystone module USB 3.0	99204	black	5
Keystone module HDMI	99205	black	5
Keystone module CAT 6	99206	silver	5

Bulkhead couplings

Type	Order No.	suitable for pneumatic hose	Thread	PU
Bulkhead coupling D4	99210	4 mm	M12 x 1.0	10
Bulkhead coupling D6	99211	6 mm	M14 x 1.0	10

Dust caps

Type	Order No.	suitable for	PU
Dust caps for HDMI	99207	HDMI connectors	5
Dust caps for USB	99208	USB connectors	5
Dust caps for RJ-45	99209	RJ-45 connectors	5

Keystone modules, bulkhead couplings and accessories

The Keystone modules and bulkhead couplings are also available individually for use with the adapter grommets.

Advantages & benefits

- By utilising the adapter grommets, connectors can be integrated directly into the cable entry frame
- Separate cut-outs for connectors are no longer necessary
- Space-saving solution
- Snap-in assembly

Specifications

Material	Bulkhead coupling: Brass nickel plated
Flame class	UL 94 V-0, self-extinguishing
Protection class	IP54 depending on module type and manufacturer
Temperature Properties	-40°C to +100°C (static) Halogen free, silicone free



1.2 Cable entry systems for the QT grommet system



1.2

The QUICK systems are the perfect solution for the routing of cables with and without connectors when cost-effectiveness is the priority.

Here, too, the concept of consistent divisibility is applied. This system places great emphasis on tool-free assembly, for example in combination with the KEL-SNAP frame.

With the split QT grommets, cable diameters from 1 to 29 mm can be covered. With correct assembly, a protection class of IP54 is achieved.

The QTMB grommets allow the routing of cables with diameters that can vary up to 3 mm. By using the QT-DT grommet, the packing density of the cables can be considerably increased and the required installation space considerably reduced.

1.2

 <p>Split cable entry frames for quick assembly, for standard cut-outs, for cable diameters up to 29 mm</p> <p>KEL-QUICK 94 – 97</p>	 <p>Split cable glands for screw-in assembly, for standard cut-outs, for cable diameters up to 15 mm</p> <p>QVT 98 – 100</p>	 <p>Split cable glands for screw-in or snap-in assembly, for standard cut-outs, for cable diameters up to 29 mm</p> <p>QVT-CLICK 98 – 101</p>
 <p>Split cable entry plates for push-in assembly, for standard cut-outs, for cable diameters up to 15 mm</p> <p>KEL-QTA / KEL-QTE 102 – 105</p>	 <p>Cable grommets for the QT system, split and not split, for cables with/without connectors, for cable diameters 1 – 29 mm</p> <p>106 – 110</p>	 <p>QT Servicebox Service box for cable grommets</p> <p>111</p>
 <p>IMAS-CONNECT™ Modular adapter system for the QT system</p> <p>112 – 120</p>	 <p>Snap mounting frames for installation of KEL-U/KEL frames, split (KEL-SNAP-S)</p> <p>KEL-SNAP-S / KEL-SNAP 46 – 49</p>	 <p>Thread extension for cable glands and cable entry plates M32, M50, M63</p> <p>TE-M 290 – 291</p>

1.21 Split cable entry frames for the QT grommet system



1.21

With the new version of the compact, split cable entry system KEL-QUICK icotek released a highly efficient and cost-effective possibility for routing and IP54 sealing of cables with or without connectors, conduits and pneumatic hoses.

The cable entry system KEL-QUICK is an outstanding alternative to cable glands. Especially for applications that do not necessarily require standard-compliant strain relief acc. to EN 62444, the KEL-QUICK is the perfect solution.

Split cable grommets of the QT series are used for routing lines with diameters of 1 – 29 mm within the KEL-QUICK. In addition, there are multi-hole grommets for up to 4 lines per slot and special grommets e.g. for ASI cables.

After equipping the frame with the cables or hoses, the cover lid of the KEL-QUICK is simply snapped onto the frame. A fast and easy assembly is the biggest benefit when using the QUICK series – when used with the KEL-SNAP or KEL-SNAP-S frame a complete tool-free installation is possible.

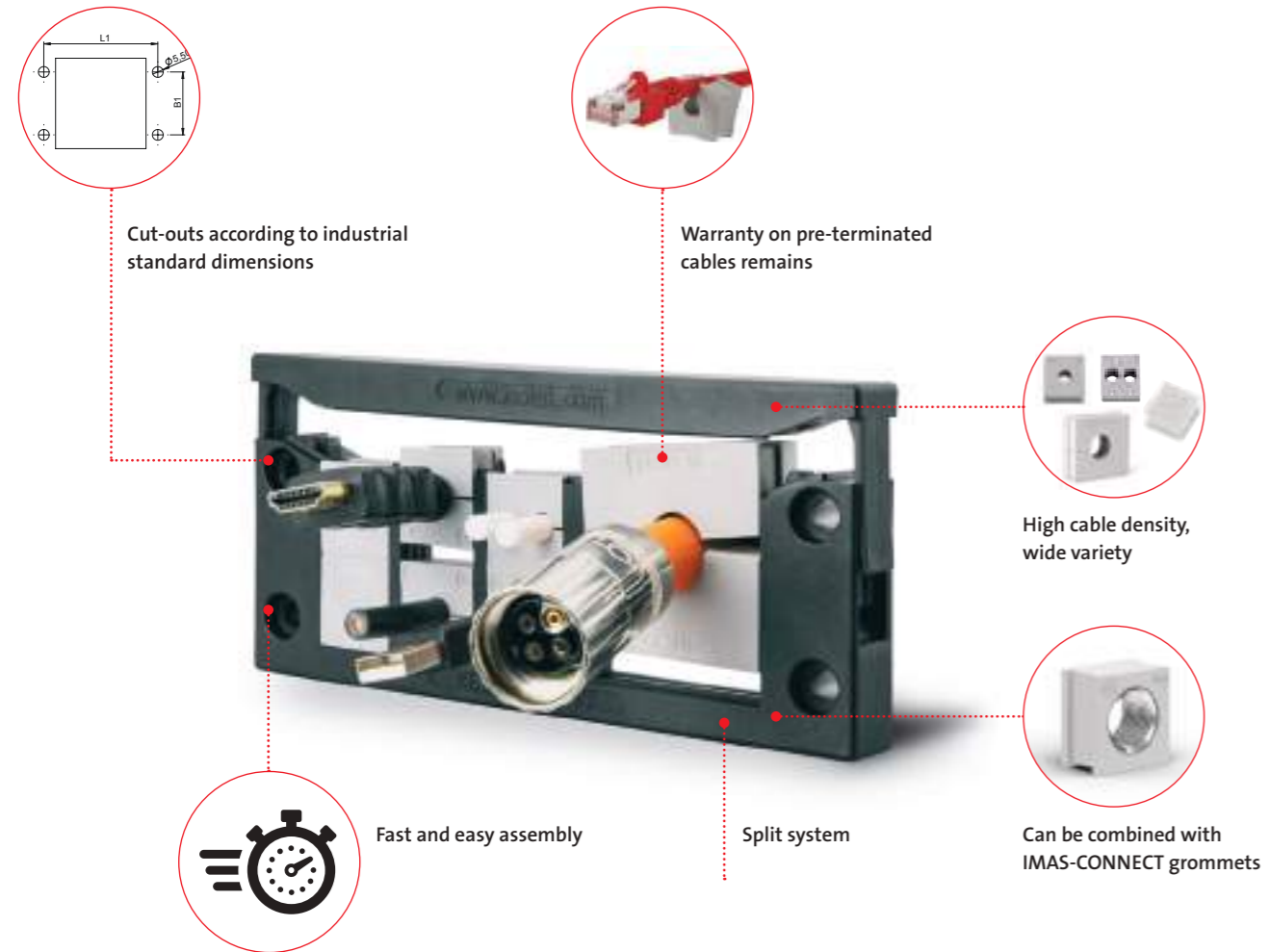

Cable entry frames for quick assembly with IP54 rating KEL-QUICK series

The KEL-QUICK range is a compact system to route and seal pre-terminated cables as well as conduits or pneumatic hoses utilising split QT and QTMB grommets. After populating the entry frame with QT/QTMB grommets and cables, the cover lid is snapped onto the frame without using assembly hardware.

The KEL-QUICK frames match exactly the cut-out dimensions for 10-, 16- and 24-pin standard industrial connectors. The KEL-QUICK-B frames match the cut-out dimensions 46 x 36 mm. These KEL-QUICK frames can either be screw mounted or simply snapped into the KEL-SNAP frame.

The single-row KEL-QUICK-E versions are particularly suited for flat connectors. The small frames are ideal for applications with limited space.

A flat rubber gasket is included in the shipment.

Advantages & benefits

- Fast and easy assembly and when used with the KEL-SNAP frame, mounting without tools possible
- Maintain manufacturer's warranty on pre-terminated cables
- Retrofittings, repairs and maintenance can be done much more easily and quickly
- High cable density, wide variety of grommets
- Can be combined with IMAS-CONNECT grommets

Specifications

Material	Polyamide (PA)
Flame class	UL 94 V-0, self-extinguishing
IP rating	IP54, with gasket and correct selection of the cable grommets
Temperature	-40°C to +140°C (static)
Properties	Halogen-free, silicone-free
Frame depth	17 mm

Accessories

QT Cable grommets	106 - 111
KEL-SNAP Mounting frames	46 - 49
KEL-EMC Cable collectors	224 - 226
KDR Base plates	258 - 267
FP Flange plates	276 - 285
MP Module plates	270 - 271
ST Plugs	77

Single-piece packaging units are available on request.

1.21

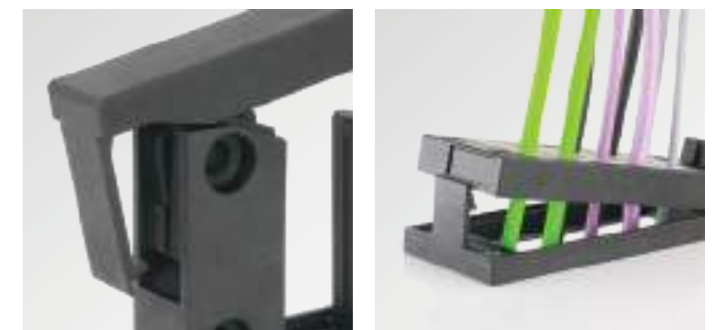

Cover lid is simply snapped onto the frame

Tool-free mounting with KEL-SNAP frame



KEL-QUICK-E

Split grommets



KEL-QUICK
Cable entry frames
for quick assembly
KEL-QUICK 24, KEL-QUICK 16,
KEL-QUICK 10, KEL-QUICK-B



IP54

KEL-QUICK
Cable entry frames
for quick assembly
KEL-QUICK-E



IP54

1.21

Description	Cut-out Drilling template	Type	Order No.	Cut-out [mm]	Grommets	PU
		KEL-QUICK 24 10	42410	112 × 36	10 –	10
		KEL-QUICK 24 7	42412	112 × 36	6 1	10
		KEL-QUICK 24 4	42413	112 × 36	2 2	10
		KEL-QUICK 16 8	42418	86 × 36	8 –	10
		KEL-QUICK 16 5	42425	86 × 36	4 1	10
		KEL-QUICK 16 2	42426	86 × 36	0 2	10
		KEL-QUICK 10 6	42420	65 × 36	6 –	10
		KEL-QUICK 10 3	42427	65 × 36	2 1	10

1.21

Description	Cut-out Drilling template	Type	Order No.	Cut-out [mm]	Grommets	PU
		KEL-QUICK-B4	42434	46 × 46	4 –	10
		NEW KEL-QUICK-B1	42435	46 × 46	– 1	10
		KEL-QUICK-E5	42424	24 × 112	5 QT	10
		KEL-QUICK-E4	42423	24 × 86	4 QT	10
		KEL-QUICK-E3	42422	24 × 65	3 QT	10
		KEL-QUICK-E2	42421	24 × 43	2 QT	10

1.22 Split cable glands for the QT grommet system



1.22

By using split QVT cable glands by icotek cables with or without connectors or complete cable harnesses with diameters from 1 to 15 mm can be quickly routed into enclosures, cabinets or machines and be sealed with IP54 rated ingress protection.

The split system of the QVT cable glands enables quick and easy assembly which is great for retrofitting and maintenance. The cable is placed into the split grommet which is set into one of the gland halves. Depending on the size of the cable gland one, two or four separate grommets can be

installed. The two gland halves can be easily snapped together without the need of tools. The routed lines are securely sealed and held inside the grommets. To mount the cable glands either snap it into the round metric standard cut-out (sizes available from M16 to M50) or screw it with a hexagonal locknut. The mounting method is dependent on the model type.

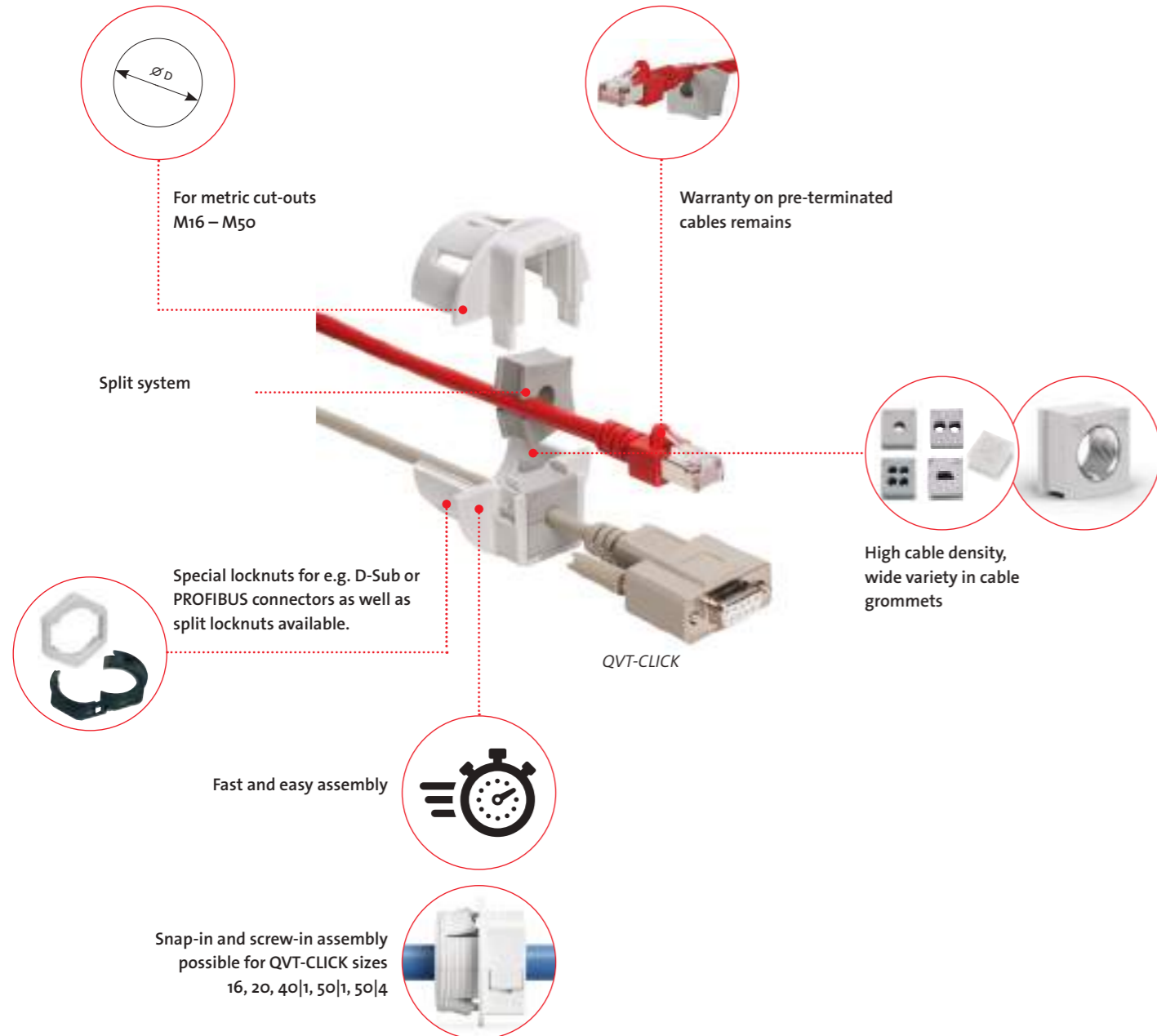

Split cable glands for snap-in or screw-in assembly with IP54 rating QVT | QVT-CLICK

QVT and QVT-CLICK are circular split frames for quick and easy installation of pre-terminated cables or complete cable harnesses. But also electric, pneumatic or hydraulic lines without terminals or connectors as well as corrugated conduits can be easily routed and sealed with IP54. Because of its extremely compact design, the QVT/QVT-CLICK range is especially suitable for small machines, devices and instruments.

The cable glands are easy to install. The prefabricated cable is placed into the split grommet which is set into one of the gland halves. Depending on the size of the cable gland, one, two or four separate grommets can be installed. By using multi-hole grommets up to 16 lines can be routed with one cable gland.

The QVT-CLICK can be assembled without tools from the front of the enclosure wall. Sizes QVT-CLICK 16, QVT-CLICK 20, QVT-CLICK 40|1, QVT-CLICK 50|1 and QVT-CLICK 50|4 can also be screwed on with a lock nut.

QVT: Polyamide lock nuts as well as a sealing ring are included in the shipment. QVT-CLICK: A sealing ring is included in the shipment.

Advantages & benefits QVT

- Compact design
- Routing of pre-terminated cables
- Maintain manufacturer's warranty on pre-terminated cables
- Retrofittings, repairs and maintenance can be done much more easily and quickly
- Suitable for metric cut-outs
- Lock nut is included
- Can be combined with IMAS-CONNECT system

Advantages & benefits QVT-CLICK

- Fast and easy mounting from the front
- Snap in assembly QVT-CLICK 16/20 for wall thickness 1.5 – 2.5 mm
- Snap in assembly QVT-CLICK 25/32/40/50 for wall thickness 1 – 2.5 mm
- Screw in assembly possible for QVT-CLICK sizes 40|1, 50|1 and 50|2 for a wall thickness of 11 mm, for QVT-CLICK sizes 16 and 20 for a wall thickness up to 5 mm
- Snap-in and screw-in assembly possible for QVT-CLICK sizes 16, 20, 40|1, and for 50|1 and 50|4.

Specifications

Material	Polycarbonate (PC)
Colour	grey (similar RAL 7035)
Flame class	UL 94 V-0, self-extinguishing
IP rating	IP54, with gasket and correct selection of the cable grommets
Temperature	- 30°C to + 100°C (static)
Properties	Halogen-free, silicone-free
Cut-out dimension	Metric sizes

Accessories

KGM lock nuts 292

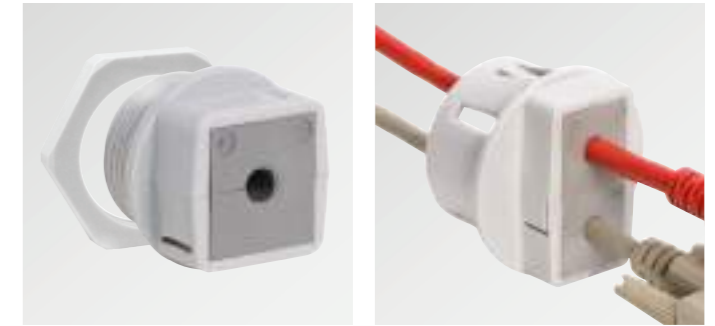

QVT

QVT-CLICK

1.22

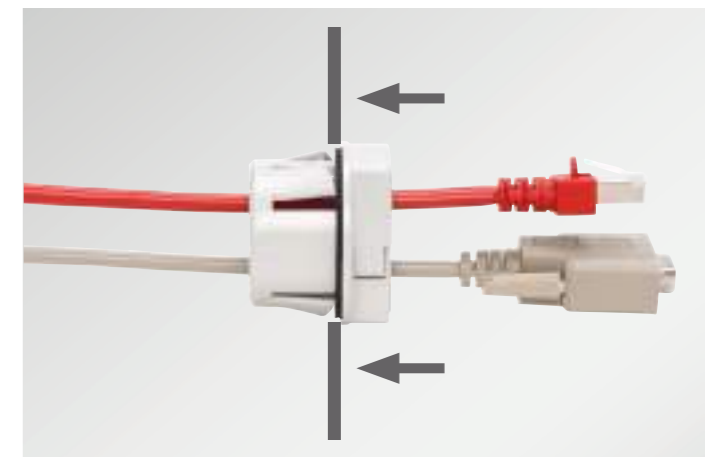

QVT-CLICK: Fast and easy mounting from the front



QVT – back view

QVT-CLICK: for screw-in or snap-in assembly



The QVT-CLICK Tool for quick and easy mounting. Order No. 61435 (PU: 1)

QVT
Split cable glands

QVT-CLICK
Split pluggable cable glands

IP54



IP54



1.22

Description	Type	Order No.	Cable Grommets	Thread Thread length	PU
	QVT 16* •	45692	1 × QT	M16 × 1.5 Length: 13 mm	10
	QVT 20**	45695	1 × QT	M20 × 1.5 Length: 13 mm	10
	QVT 25	45702	1 × QT	M25 × 1.5 Length: 13 mm	10
	QVT 32	45711	1 × QT	M32 × 1.5 Length: 13 mm	10
	QVT 40 2	45715	2 × QT	M40 × 1.5 Length: 13 mm	10
	QVT 50 4	45722	4 × QT	M50 × 1.5 Length: 13 mm	10

* Max. cable diameter of 10 mm | ** Max. cable diameter of 11 mm
♦ Cannot be combined with QT-AT-K-M

Accessories

- QT Cable grommets 106 - 111
- KVT-EMC Brackets 227
- KGM Locknuts 292
- ST Plugs 77



Type GMT: Split locknut, p. 292

Single-piece packaging units are available on request.

1.22

Description	Type	Order No.	Cable Grommets small large	Cut-out* diameter	Thread Thread length	PU
	QVT-CLICK 16 *** ••	45726	1 –	16.2 mm	M16 × 1.5 Length: 13 mm	10
	QVT-CLICK 20 *** ••	45728	1 –	20.4 mm	M20 × 1.5 Length: 13 mm	10
	QVT-CLICK 25	45730	1 –	25.5 mm	–	10
	QVT-CLICK 32	45732	1 –	32.5 mm	–	10
	QVT-CLICK 40 1 **	45736	– 1	40.5 mm	M40 × 1.5 Length: 19 mm	10
	QVT-CLICK 40 2	45734	2 –	40.5 mm	–	10
	QVT-CLICK 50 1 **	45738	– 1	50.5 mm	M50 × 1.5 Length: 19 mm	10
	QVT-CLICK 50 4 **	45740	4 –	50.5 mm	M50 × 1.5 Length: 19 mm	10

* Please consider any paint layers or powder coatings!
** Pluggable and screwable; locknut is not included in the shipment
• Sizes M16 und M20 for wall thickness up to 5 mm (screw-in assembly)
• Max. cable diameter of 10 mm
•• Max. cable diameter of 11 mm
♦ Cannot be combined with QT-AT-K-M

Single-piece packaging units are available on request.

1.23 Split cable entry plates for the QT grommet system



KEL-QTA are push-in, split IP54 cable entry plates for wall thicknesses from 1.5 to 4 mm. icotek offers several versions for rectangular standard cut-outs as well as for round metric cut-outs. The QTA system offers a large size variety.

Split cable grommets of the QT series are used for the routing of pre-terminated cables with diameters of 1–15 mm within the KEL-QTA. In addition, there are multi-hole grommets for up to 4 lines per slot and special grommets e.g. for ASI cables.

KEL-QTA enable cable routing with or without preassembled connectors. Some types offer a combination of membranes for cable pass-through and the QT grommet system.

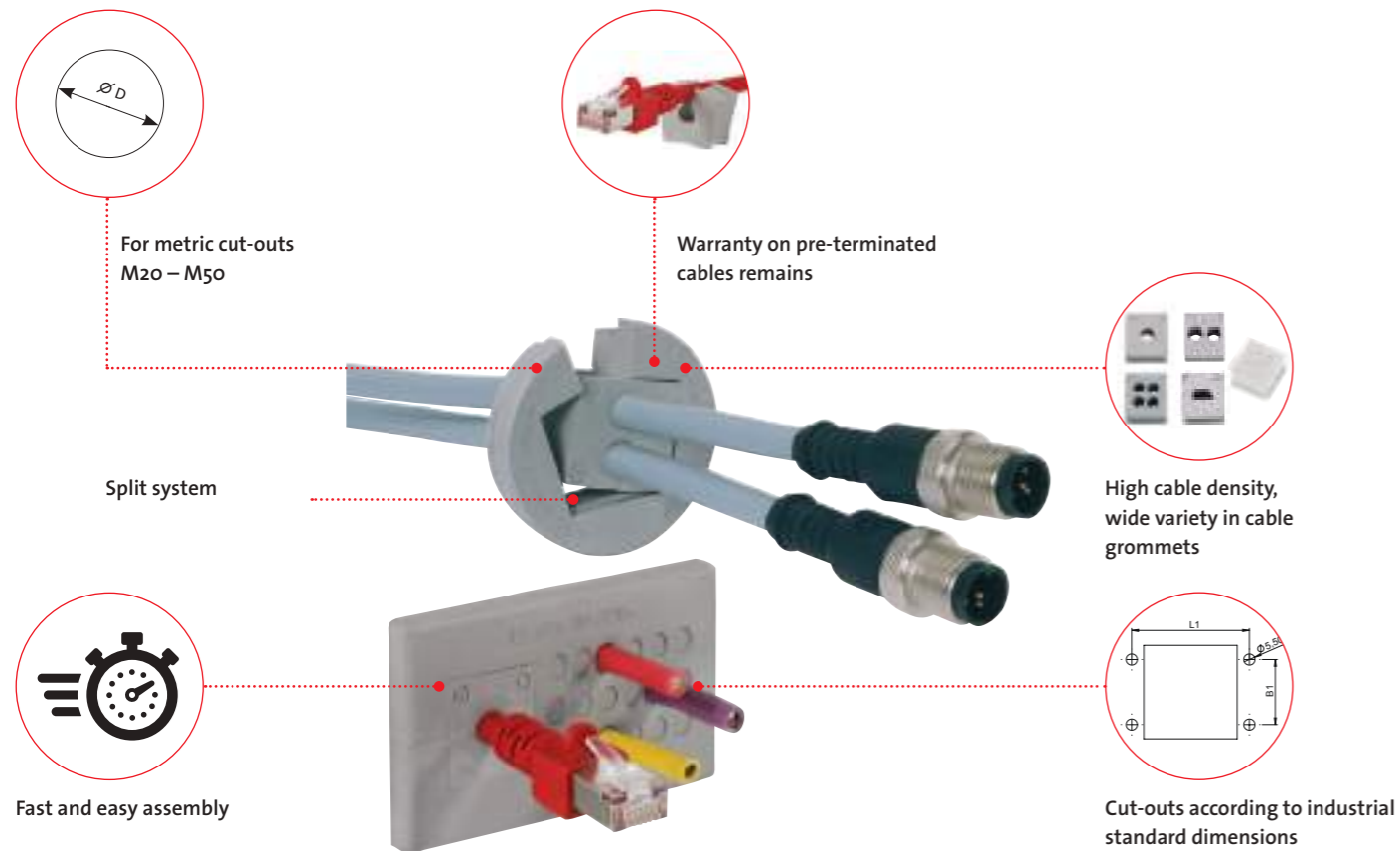

Push-in, split cable entry plates for snap-in assembly with IP54 rating
KEL-QTA | KEL-QTE

Push-in, split cable entry plates (IP54) for routing pre-terminated and standard cables utilising split QT grommets or membranes. Suitable for cut-outs for 10- and 24-pin industrial connectors. The compact size KEL-QTA-B is suitable for cut-outs 45.5 x 45.5 mm. The round versions of the KEL-QTA are suitable for cut-outs 32/50 mm in diameter.

The KEL-QTA/KEL-QTE easily routes pre-terminated cables, multi-conductors, hoses or conduits without using any tools for assembly.

The KEL-QTE fits on cut-outs of 20 mm in diameter.

Advantages & benefits

- Fast and easy assembly without tools
- High cable density by using multi-position grommets
- Simple assembly and disassembly in case of change or service
- Routing of cables with and without connectors in a high density
- Suitable for standard industrial connector cut-outs

Specifications

Material	Elastomer
Flame class	UL 94 V-0, self-extinguishing
IP rating	IP54, with correct selection of the cable grommets (QT single)
Temperature	- 40°C to + 100°C (static)
Properties	Halogen-free, silicone-free
Cut-out dimension	Metric sizes (QTE)
Frame depth	5 mm (QTA)
Type A:	For wall thickness 1.5 - 2.5 mm
Type B:	For wall thickness 2.8 - 4 mm

Accessories

QT Cable grommets	106 - 111
ST-B Plugs	151
FP Flange plates	276 - 285



KEL-QTA



KEL-QTE

i Single-piece packaging units are available on request.

KEL-QTA
Split cable entry plates

KEL-QTA | KEL-QTE
Split cable entry plates

IP54



IP54



Description	Cut-out Drilling template	Type	Order No. Type A	Order No. Type B	Cut-out [mm]	Cables	PU
		KEL-QTA 24 2-DP 18	43642	43643	112 x 36	pre-terminated 2x 1 - 15 mm without connector 16x max. 7 mm 1x max. 12 mm 1x max. 16 mm	10
		KEL-QTA 24 4	43644	43645	112 x 36	pre-terminated 4x 1 - 15 mm	10
		KEL-QTA 10 1-DP 18	43655	43658	65 x 36	pre-terminated 1x 1 - 15 mm without connector 18x max. 5 mm	10
		KEL-QTA 10 2-DP 6	43656	43659	65 x 36	pre-terminated 2x 1 - 15 mm without connector 6x max. 5 mm	10
		KEL-QTA-B4	43660	-	46 x 46	pre-terminated 4x 1 - 15 mm	10



Single-piece packaging units are available on request.

Description	Type	Order No. Type A	Order No. Type B	Cut-out [mm]	Cables	PU	
					pre-terminated	non pre-term.	
	KEL-QTA 32	43632	43636	ø 32	1x 1 - 15 mm	-	10
	KEL-QTA 50	43622	43626	ø 50	2x 1 - 15 mm	-	10
	KEL-QTE 20 2.5	43412	-	ø 20	1x 2.6 - 3.2 mm	1x max. 5.2 mm	10
	KEL-QTE 20 3	43413	-	ø 20	1x 3.1 - 3.8 mm	1x max. 5.2 mm	10
	KEL-QTE 20 4	43414	-	ø 20	1x 3.8 - 4.8 mm	1x max. 5.2 mm	10
	KEL-QTE 20 5	43415	-	ø 20	1x 4.7 - 5.6 mm	1x max. 5.2 mm	10

Single-piece packaging units are available on request.

1.24 Cable grommets for the QT system



Cable grommets QT are used with the following cable entry components:

- KEL-QUICK
- QVT
- QVT-CLICK
- KEL-QTA

In principle, there are two types of cable grommets: split and non-split grommets. The split grommets are suitable for routing cables with connectors, the non-split ones are used for routing non-terminated cables.

Electrical, pneumatic or hydraulic lines as well as corrugated conduits and hoses can be easily routed, sealed and strain relieved using split cable entry systems.



Overview of cable entry systems and matching grommets

Product	Split cable grommets for cables with connectors			Non-split cable grommets for cables without connectors	
	QT small single-hole	QT small multi, special	QTMB large multi-range	QT-DT small	QT-DT large
KEL-QUICK	■	■	■	■	■
QVT	■	■	-	■	-
QVT-CLICK	■	■	■	■	■
KEL-QTA	■	■	-	■	-
KEL-QTE	■	■	-	■	-

Split cable grommets for cables with connectors



Split cable grommets, single
IP54 protection
for cable diameters 1 to 15 mm

QT

108

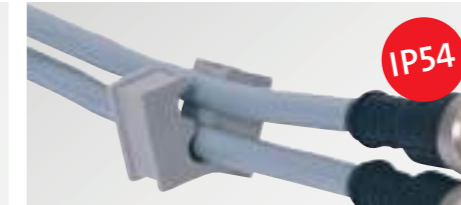

Split cable grommets, multi and special
IP54 protection
for cable diameters 3 to 7 mm

QT multi

108



Split multi-range cable grommets
IP54 protection
for cable diameters 14 to 29 mm

QTMB

109

Non-split cable grommets for cables without connectors



Membrane cable grommets
IP54 protection, high cable density
for cable diameters 6.5 to 14.5 mm

QT-DT

110



QT Servicebox
Service box for cable grommets

111



IMAS-CONNECT™
Modular adapter system
for the QT system

112 – 120

QT

Split cable grommets, small, single, multi and special, for the QUICK system

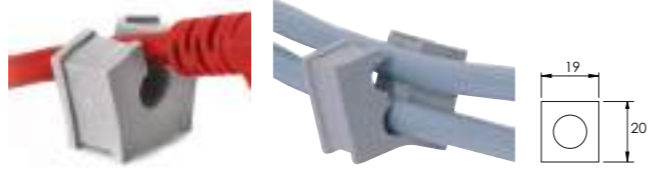

Split cable grommets QT are used with the following cable entry components:

- KEL-QUICK
- QVT
- QVT-CLICK
- KEL-QTA

They are designed for cable diameters from 1 to 15 mm. Blank grommets can seal unused grommet spaces.

When using double or quadruple grommets the cable density of cable entry frames and cable glands can be greatly increased. icotek also offers special cable grommets for e.g. ASI lines.

When installing the small grommets in multiple rows, the flat sides should be facing each other. This allows the flat sides to match up and provide a secure seal.

Advantages

- Routing of cables with and without connectors
- IP54 rating
- Greatly increased cable density when using double or quadruple grommets
- Strain relief when a suitable cable entry is selected
- Available for a wide range of cable diameters

Specifications

Material	Elastomer
Flame class	UL 94 V-o, self-extinguishing
IP rating	IP54
Temperature	-40°C to +100°C (static)
Properties	Halogen-free, silicone-free

Description	Type	Order No.	Clamping range	PU
	QT 1	42501	1 – 2 mm	10
	QT 2	42502	2 – 3 mm	10
	QT 3	42503	3 – 4 mm	10
	QT 4	42504	4 – 5 mm	10
	QT 5	42505	5 – 6 mm	10
	QT 6	42506	6 – 7 mm	10
	QT 7	42507	7 – 8 mm	10
	QT 8	42508	8 – 9 mm	10
	QT 9	42509	9 – 10 mm	10
	QT 10	42510	10 – 11 mm	10
	QT 11	42511	11 – 12 mm	10
	QT 12	42512	12 – 13 mm	10
	QT 13	42513	13 – 14 mm	10
	QT 14	42514	14 – 15 mm	10
	QTB	42540	Blank grommet	10
	QT 2 x			
	QT 2 3	42566	2x Ø 3 mm	10
	QT 2 4	42568	2x Ø 4 mm	10
	QT 2 5	42570	2x Ø 5 mm	10
	QT 2 5.5	42571	2x Ø 5.5 mm	10
	QT 2 6	42572	2x Ø 6 mm	10
	QT 2 6.5	42576	2x Ø 6.5 mm	10
	QT 2 7	42578	2x Ø 7 mm	10
	QT 4 x			
	QT 4 3	42580	4x Ø 3 mm	10
	QT 4 4	42582	4x Ø 4 mm	10
	QT 4 4.5	42583	4x Ø 4.5 mm	10
	QT 4 5	42584	4x Ø 5 mm	10
	QT 4 5.5	42585	4x Ø 5.5 mm	10
	QT 4 6	42586	4x Ø 6 mm	10
	QT-ASI 1	42573	1x ASI-cable	10
	QT-ASI 2	42574	2x ASI-cable	10
	QT tele	42575	Telephone cable	10



QTMB

Split multi-range grommets, large, for the QUICK system



Description	Type	Order No.	Clamping range	PU
	QTMB 14–17	42515	14–17 mm	10
	QTMB 16–19	42516	16–19 mm	10
	QTMB 18–21	42517	18–21 mm	10
	QTMB 20–23	42518	20–23 mm	10
	QTMB 22–25	42519	22–25 mm	10
	QTMB 24–27	42520	24–27 mm	10
	QTMB 26–29	42521	26–29 mm	10
	QTMB-BTG	42545	Blank grommet	10

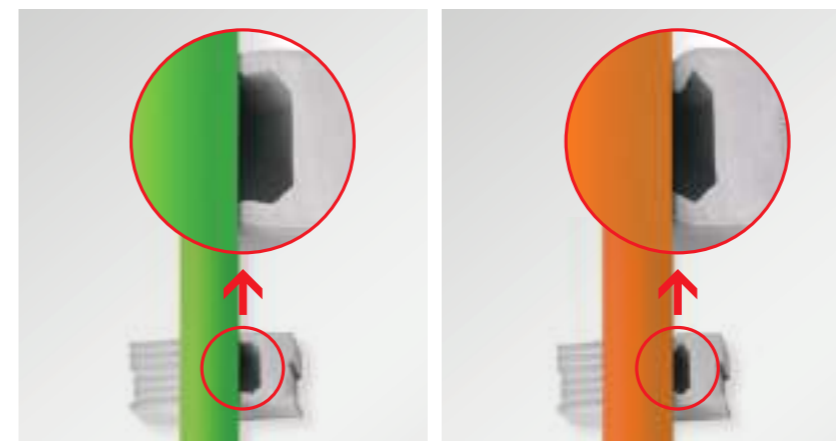

The multi-range grommet QTMB is used to route pre-terminated cables into the KEL-QUICK system.

The innovative membrane enables the routing of cables with diameters that can vary up to 3 mm.

The QTMB can also be used to insert large cables with a clamping range of 14 to 29 mm.

Advantages

- Routing of cables with and without connectors
- IP54 rating
- Strain relief when a suitable cable entry is selected
- Large clamping range
- Only 7 grommets cover a clamping range from 14 to 29 mm
- Innovative wave cut for a better sealing
- Innovative membrane for high flexibility

Specifications

Material	Elastomer
Flame class	UL 94 V-o, self-extinguishing
IP rating	IP54
Temperature	-40°C to +100°C (static)
Properties	Halogen-free, silicone-free

i ST-B plug for the sealing of the perforated membrane



QT-DT

Membrane cable grommets ,
non-split,
for the QUICK system

IP54



The QT-DT membrane cable grommet enables the routing of cables without connectors. Using the QT-DT grommet considerably increases the cable packing density and decreases the space needed. This new grommet can be used in the KEL-QUICK cable entry frames as well as in the KEL-QTA cable entry plates. Therefore, it is possible to insert cables with and without connectors into one cable entry system.

Advantages

- Combination of pre-assembled and non-assembled cables in one cable entry product
- Very high packing density
- Considerable space and cost savings
- Pre-assembly of individual assemblies possible

Specifications

Material	Elastomer
Flame class	UL 94 V-0, self-extinguishing
IP rating	IP54
Temperature	-40°C to +100°C (static)
Properties	Halogen-free, silicone-free

Accessories

ST Plugs 77

Description	Type	Order No.	Clamping range	PU
QT-DT small	QT-DT 1	42550	4x max. 6.5 mm	10
QT-DT 2	QT-DT 2	42551	2x max. 3.5 mm 2x max. 6.5 mm	10
QT-DT 3	QT-DT 3	42552	9x max. 3.5 mm	10
QT-DT large	QT-DT 8	42556	12x max. 6.5 mm 2x max. 12.2 mm	10
QT-DT 9	QT-DT 9	42557	15x max. 7.1 mm	10
QT-DT 10	QT-DT 10	42558	4x max. 6.5 mm 3x max. 9.5 mm 3x max. 11.3 mm	10
QT-DT 11	QT-DT 11	42559	9x max. 9.5 mm	10
QT-DT 12	QT-DT 12	42560	4x max. 14.5 mm 1x max. 9.5 mm	10

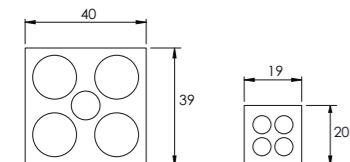

QT ServiceBox

Service box
for cable grommets



Convenient – everything available right away!

The QT ServiceBox is perfect for installations and service calls. It ensures your QT grommets are readily available.

Order No. 88005

Content*

Cable grommets:

- 210 QT for cables 1 - 15 mm
- 10 QTB blank grommets
- 1 QT-DT 1
- 1 QT-DT 2
- 1 QT-DT 3

Cable entry components:

- 1 KEL-QTA 50 A cable entry plates
- 1 KEL-QTA 32 A cable entry plate
- 1 KEL-QTA 24|2-DP 18 A cable entry plate
- 1 KEL-QTA 10|1-DP 18 A cable entry plate
- 1 KEL-QUICK 24|10 cable entry frame
- 1 QVT 25 split cable gland
- QVT-CLICK 32 split cable gland

Accessories:

- Cable template

* Subject to alterations



KMS Cable template



The correct size of the QT grommets can easily be determined by using the cable template

- Determining the diameter of the cable using the cable template
- Selecting the QT grommets according to the data on the cable template

Cable templates can also be ordered separately. Order-No. 39800

i Now the assortment cases for different types and sizes of cable grommets can be configured individually. So the perfect grommets are always at hand: www.icotek.com/en/config/626044

1.25 Modular adapter system IMAS-CONNECT™ for the QT system



Simply configure the most individual cable entry in the world

At the same time the system serves as a unique interface for connectors. This means you only need one single interface for a wide range of cables and connections.

The IMAS-CONNECT™ adapter system is a modular designed grommet system for mounting metric connectors, PushPull modules, Keystone couplers, hose fittings, pressure compensation elements and much more.

The grommets, made of elastomer with a polyamide body, fit perfectly into the cable entry frames e.g. KEL-QUICK and meet the protection class IP54.

By utilising the modular adapter system, the cable entry frame becomes a hybrid system. Pre-terminated and standard cables or hoses can be routed.

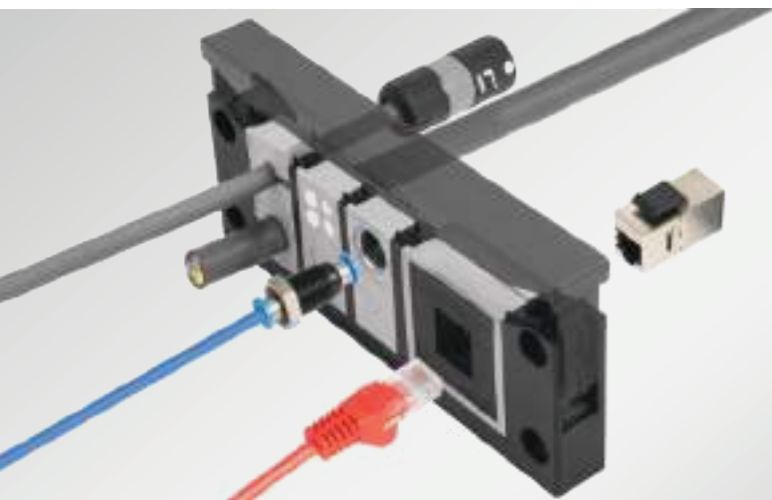

Available with pre-terminated cut-out for PushPull systems (QT-AT-PP)

Adapter grommet for M23 square flange (QT-AT-FL)

Available with threaded insert (QT-AT-K-M), based on the QT cable grommet

Available with metric inner threads of M12 x 1.0, M16 x 1.5, M20 x 1.5 and M25 x 1.5 (QT-AT-M)

Usable area for special cut-outs and drill-holes: 24 x 24 mm; Wall thickness: 6 mm (QT-AT-B)

Perfect integration into the split cable entry frames

At a high cable density only one cut-out is necessary

Elastomer grommet with polyamide body based on the grommet QT large

Protection class IP54

Available with pre-terminated cut-out for Keystone couplers (QT-AT-KS)

 <p>Adapter grommet, large for M23 square flange QT-AT-FL</p> <p>114</p>	 <p>Adapter grommet, large for PushPull connector systems QT-AT-PP</p> <p>115</p>	 <p>Adapter grommet, large for Keystone couplers QT-AT-KS</p> <p>116</p>
 <p>Adapter grommet, small with threaded insert QT-AT-K-M</p> <p>117</p>	 <p>Adapter grommet, large with metric inner thread QT-AT-M</p> <p>118</p>	 <p>Adapter grommet, blank, large QT-AT-B</p> <p>118</p>
 <p>Adapter grommet, large with mounted Keystone modules, product set</p> <p>119</p>	 <p>Keystone modules, single bulkhead couplings and accessories</p> <p>120</p>	

Various application examples

USB, RJ45, HDMI and approx. 70 other Keystone couplers.

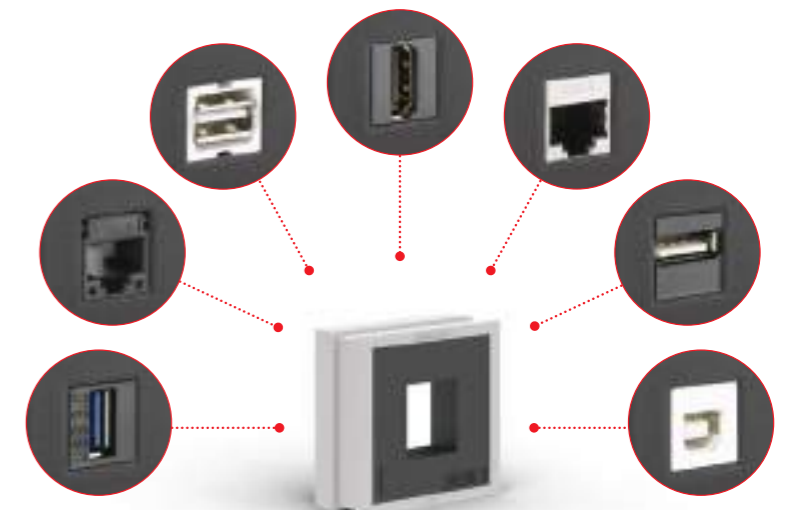

QT-AT-FL

Adapter grommet, large for M23 square flange



Type	Order No.	Height x width x length [mm]	Material	PU
QT-AT-FL	42608	42 x 41.5 x 19	PA/Elastomer	5

The grommet QT-AT-FL is constructed on the basis of a large QT cable grommet. The polyamide body is moulded with elastomer. All square flanges with dimensions 19.8 x 19.8 mm (M23) can be integrated.

The insertion of QT-AT-FL into an icotek cable entry frame enables the routing of cables with and without connectors in combination with the creation of interfaces for M23 connectors within one cable entry system. Separate cut-outs for connectors are no longer necessary.

QT-AT-FL provides ingress protection of up to IP54 (depending on the used flange and connector).

Advantages & benefits

- By using the QT-AT-FL grommet, connectors can be integrated directly into the cable entry frame
- Separate cut-outs for connectors are no longer necessary
- Space-saving solution
- Cost-saving assembly

Specifications

Material	Grommet: Elastomer Body: Polyamide
Flame class	UL 94 V-0, self-extinguishing
Protection class	IP54, IP55, IP64, IP65
Temperature	-40°C to +90°C (static)
Properties	Halogen free, silicone free

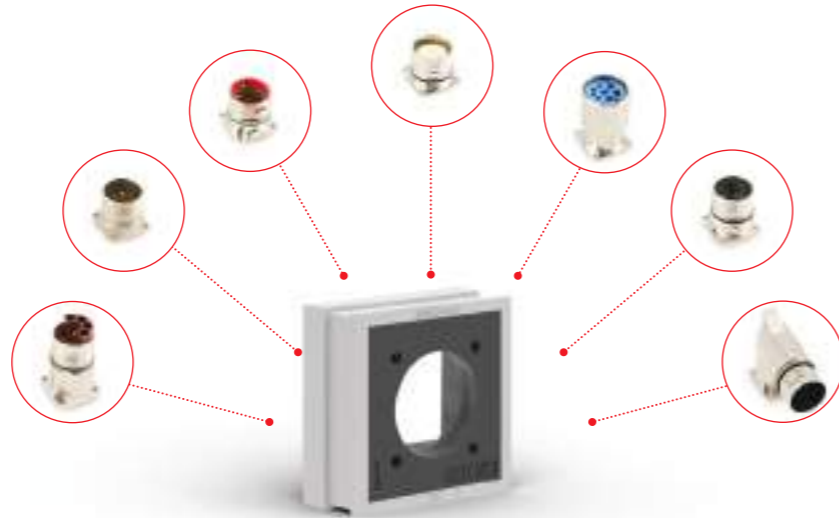

QT-AT-PP

Adapter grommet, large for PushPull connector systems



Type	Order No.	Height x width x length [mm]	Material	PU
QT-AT-PP	42602	39 x 40 x 17	PA/Elastomer	10

The grommet QT-AT-PP is constructed on the basis of a large QT cable grommet. In this elastomer grommet, a polyamide body is integrated. All modules based on the PushPull system can be inserted into the grommet.

By using the grommet QT-AT-PP, the split cable entry frame can be used to route pre-terminated cables and at the same time it can also be used as an interface for connectors. This can save additional cut-outs and reduce labour costs.

PushPull modules and add-on housings are not included in the scope of delivery.

Advantages & benefits

- By using QT-AT-PP grommets, panel connectors and sockets can be integrated directly into the cable entry system
- Separate cut-outs for connectors are no longer necessary
- Time saving solution
- Space-saving solution
- Assembly costs are reduced

Specifications

Material	Grommet: Elastomer Body with thread: Polyamide
Flame class	UL 94 V-0, self-extinguishing
Protection class	IP54 when using correct components
Temperature	-40°C to +100°C (static)
Properties	Halogen free, silicone free



The module (left) snaps into the rear of the add-on housing mounted on the QT-AT-PP.



QT-AT-KS

Adapter grommet, large for Keystone couplers



The grommet QT-AT-KS is constructed on the basis of a QT cable grommet. In this elastomer grommet, a polyamide body is integrated. All couplers based on the Keystone system can be simply snapped in.

By using the grommet QT-AT-KS, the split cable entry frame can be used to route pre-terminated cables and at the same time it can also be used as an interface for connectors. This can save additional cut-outs and reduce labour costs.

Advantages & benefits

- By utilising the QT-AT-KS grommet, connectors can be integrated directly into the cable entry frame
- Separate cut-outs for connectors are no longer necessary
- Space-saving solution
- Grommet is suitable for all Keystone couplers
- Snap-in assembly

Specifications

Material Grommet: Elastomer
Body: Polyamide
Flame class UL 94 V-0, self-extinguishing
Protection class IP54 depending on Keystone module and manufacturer
Temperature -40°C to +100°C (static)
Properties Halogen free, silicone free

Type	Order No.	Height x width x length [mm]	Material	PU
QT-AT-KS	42601	39 x 40 x 17	PA/Elastomer	10

Type	Order No.	Height x Width x Length [mm]	Colour Keystone module	PU
QT-AT-KS-USB 3.0	42644	39 x 40 x 17	black	1
QT-AT-KS-HDMI	42645	39 x 40 x 17	black	1
QT-AT-KS-CAT6	42646	39 x 40 x 17	silver	1



USB, RJ45 or e.g. HDMI connectors can be plugged in from the front and from the back.



QT-AT-K-M

Adapter grommet, small with threaded insert



Type	Order No.	Height x Width x Length [mm]	Thread	Material	PU
QT-AT-K-M 5x0.5	42604	20 x 19 x 17	M5 x 0.5	Brass/Elastomer	5
QT-AT-K-M 8x0.5	42609	20 x 19 x 17	M8 x 0.5	Brass/Elastomer	5
QT-AT-K-M 8x1.0	42605	20 x 19 x 17	M8 x 1.0	Brass/Elastomer	5
QT-AT-K-M 12x1.0	42606	20 x 19 x 17	M12 x 1.0	Brass/Elastomer	5
QT-AT-K-M 12x1.5	42607	20 x 19 x 17	M12 x 1.5	Brass/Elastomer	5

The QT-AT-K-M grommet is constructed on the basis of a QT cable grommet. The grommets are made of elastomer with a nickel-plated brass body. The QT-AT-K-M grommets are available with inner threads in sizes M5 x 0.5, M8 x 0.5, M8 x 1.0, M12 x 1.0, M12 x 1.5.

By using the QT-AT-K-M adapter grommet, several connectors can be inserted directly into the cable entry frame, e.g. pneumatic bulkhead connectors M12 x 1.0 and M14 x 1.0, metric connectors and pressure compensation elements.

They are compatible with all split icotek cable entry systems that are suitable for QT cable grommets.

Advantages & benefits

- By using QT-AT-K-M grommets, panel connectors and sockets can be integrated directly into the cable entry system
- Separate cut-outs for connectors are no longer necessary
- Space-saving solution
- Thread sizes M5 to M12 available

Specifications

Material Grommet: Elastomer
Body: nickel-plated brass
Flame class UL 94 V-0, self-extinguishing
Protection class IP65 when using correct components
Temperature -40°C bis +100°C (static)
Properties Halogen free, silicone free



QT-AT-M | QT-AT-B

Adapter grommet, large with metric inner thread



QT-AT-M is a grommet (based on large QT grommets) with integrated metric threads, suitable for split icotek cable entry systems. The QT-AT-M grommets are made of elastomer with a polyamide body. QT-AT-M grommets are available with inner threads in sizes M12x1.0, M16x1.5, M20x1.5 and M25x1.5.

The QT-AT-M is ideal for creating an interface for signal, data, power and hybrid connectors by simply screwing them into the QT-AT-M thread. Pressure compensation elements or conduit connectors up to M25x1.5 can also be screwed into the QT-AT-M.

There is also a blank QT-AT-B grommet available. The integrated polyamide body is completely closed on one side. The effective area is 24 x 24 mm, the wall thickness is 6 mm. Custom drill-holes and cut-outs can be made here for e.g. installation of screw mounted hybrid connectors.

icotek also offers screw plugs for sizes M16, M20 and M25 to close the new adapter grommet with the metric internal thread QT-AT-M.

Advantages & benefits

- By using QT-AT-M grommets, panel connectors and sockets can be integrated directly into the cable entry system
- Separate cut-outs for connectors are no longer necessary
- Space-saving solution
- Thread sizes M12 to M25 available

Specifications

Material	Grommet: Elastomer Body with thread: Polyamide
Flame class	UL 94 V-0, self-extinguishing
Protection class	IP54 when using correct components
Temperature	-40°C to +100°C (static)
Properties	Halogen free, silicone free

Type	Order No.	Height x Width x Length [mm]	Thread	Material	PU
QT-AT-M 12x1,0	42596	39 x 40 x 17	M12 x 1.0	PA/Elastomer	10
QT-AT-M 16x1,5	42597	39 x 40 x 17	M16 x 1.5	PA/Elastomer	10
QT-AT-M 20x1,5	42598	39 x 40 x 17	M20 x 1.5	PA/Elastomer	10
QT-AT-M 25x1,5	42599	39 x 40 x 17	M25 x 1.5	PA/Elastomer	10
QT-AT-B blank	42600	39 x 40 x 17	-	PA/Elastomer	10

Screw plugs for QT-AT-M

Type	Order No.	Thread	Material	PU
Screw plug M16 x 1.5	99195	M16	Polyamide	10
Screw plug M20 x 1.5	99196	M20	Polyamide	10
Screw plug M25 x 1.5	99197	M25	Polyamide	10



Type	Order No.	Height x Width x Length [mm]	Colour Keystone module	PU
QT-AT-KS-USB 3.0	42644	39 x 40 x 17	black	1
QT-AT-KS-HDMI	42645	39 x 40 x 17	black	1
QT-AT-KS-CAT6	42646	39 x 40 x 17	silver	1

Adapter grommet with mounted Keystone modules, product set

The adapter grommets type QT-AT-KS are also supplied as a convenient product set with pre-assembled keystone module.

Advantages & benefits

- By utilising the QT-AT-KS grommet, connectors can be integrated directly into the cable entry frame
- Separate cut-outs for connectors are no longer necessary
- Space-saving solution
- Keystone modules are already pre-assembled

Specifications

Material	Grommet: Elastomer Body: Polyamide
Flame class	UL 94 V-0, self-extinguishing
Protection class	IP54 depending on Keystone module and manufacturer
Temperature Properties	-40°C to +100°C (static) Halogen free, silicone free





Keystone modules, single, bulkhead couplings and accessories



The Keystone modules and bulkhead couplings are also available individually for use with the adapter grommets.

Advantages & benefits

- By utilising the adapter grommets, connectors can be integrated directly into the cable entry frame
- Separate cut-outs for connectors are no longer necessary
- Space-saving solution
- Snap-in assembly

Specifications

Material	Bulkhead coupling: Brass nickel plated
Flame class	UL 94 V-0, self-extinguishing
Protection class	IP54 depending on module type and manufacturer
Temperature	-40°C to +100°C (static)
Properties	Halogen free, silicone free

Keystone modules

Type	Order No.	Colour	PU
Keystone module USB 3.0	99204	black	5
Keystone module HDMI	99205	black	5
Keystone module CAT 6	99206	silver	5

Bulkhead couplings

Type	Order No.	suitable for pneumatic hose	Thread	PU
Bulkhead coupling	99210	4 mm	M12 x 1.0	10

Dust caps

Type	Order No.	suitable for	PU
Dust caps for HDMI	99207	HDMI connectors	5
Dust caps for USB	99208	USB connectors	5
Dust caps for RJ-45	99209	RJ-45 connectors	5



2 Cable entry systems for cables without connectors



For routing cables without connectors icotek offers a wide range of products with a lot of advantages and benefits in comparison to conventional cable glands.

The compact, slim and innovative design of the membrane-based cable entry plates offer a professional appearance and high ingress protection ratings up to IP68/UL type 4X.

Due to high cable densities especially suitable for applications where a lot of cables have to be entered through a small space.

For routing rigid and large diameter cables icotek offers highly flexible conical cable entry grommets with high protection ratings.

2



Single-piece packaging units are available on request.

Product	IP54	IP64	IP65	IP66	IP68	UL TYPE 12	UL TYPE 4X*	Strain relief	Cable Ø mm min max	Max. no. of cables	Page
KEL-DPU 24	■	■	■	■	■	■	■	■	3.2 – 20.5	32	127 – 129
KEL-DPZ 24	■	■	■	■		■		■	2.5 – 22	119	131 – 132
KEL-DPZ 16	■	■	■	■				■	3.2 – 16.2	34	133
KEL-DPZ 10	■	■	■	■				■	3.2 – 12	26	134
KEL-DPZ 6	■	■	■	■				■	2.5 – 8	27	135
KEL-DPZ-B	■	■	■	■		■		■	3.2 – 22	25	136
KEL-DPZ-E	■	■	■	■		■		■	3.2 – 12	21	137
KEL-DPZ-KL	■	■	■			■		■	3.2 – 22	72	137
KEL-DPZ round	■	■	■	■	■	■	■	■	1.5 – 22.2	78	138 – 139
KEL-DPZ-CLICK round	■	■	■	■	■			■	1.5 – 22.2	78	140 – 141
KEL-DPZ CR	■	■	■	■	■	■	■	■	1.5 – 22.2	78	338 – 340
KEL-DP 24	■	■				■			max. 16.1	48	143
KEL-DP 16	■	■				■			max. 12.6	26	144
KEL-DP 10	■	■				■			max. 12.6	26	145
KEL-DP 6	■	■				■			max. 16.1	25	146
KEL-DP-E	■	■				■			max. 12.1	21	147
KEL-DP round	■	■	■			■			max. 22.5	35	148 – 150
KEL-DPU-HD	■	■	■	■	■			■	3.2 – 20.5	32	350 – 351
KEL-DPZ-HD round	■	■	■	■	■	■	■	■	1.5 – 22.2	78	352 – 353
KEL-SCDP-TR	■	■	■						5 – 52	5	156 – 157
KEL-SCDP/-RW	■	■	■						5 – 36	1	158 – 159
KEL-DPF	■	■	■	■	■	■	■	■	3 – 70	1	160 – 161
KEL-JUMBO flex	■					■		■	27 – 68	1	163
KEL-ULTRA flex	■	■	■	■		■		■	25 – 115	1	162

2.1

Further details on certifications and technical specifications can be found on the product pages.

*4X for indoor use only

2.1 Cable entry plates for cables without connectors



High cable density

Fast and easy, partially tool-free assembly

Plugs for membranes ST-B













Compact, space-saving design

IP64 to IP68 rated protection, double cable sealing on front and back (KEL-DPU/KEL-DPZ)

Many cut-outs according to industrial standard dimensions

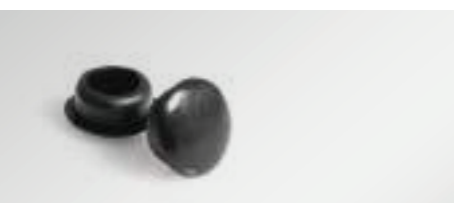
For metric cut-outs M20 – M63 (KEL-DPZ/KEL-DP round)

Flexible clamping range

 <p>IP66 IP68</p> <p>Cable entry plates for screw-in or snap-in assembly, high strain relief, for standard cut-outs</p> <p>KEL-DPU 24</p> <p>126 – 129</p>	 <p>IP66</p> <p>Cable entry plates for screw-in assembly, strain relief, for standard cut-outs</p> <p>KEL-DPZ series</p> <p>130 – 137</p>	 <p>IP65</p> <p>Cable entry plates for screw-in assembly, strain relief, for standard cut-outs</p> <p>KEL-DPZ-KL</p> <p>137</p>
 <p>IP66 IP68</p> <p>Cable entry plates, round for screw-in assembly, with thread and locknut, M25 – M63, strain relief</p> <p>KEL-DPZ round series</p> <p>138 – 139</p>	 <p>IP66 IP68 IP65</p> <p>Cable entry plates for snap-in or screw-in assembly with a locknut, M25 – M63</p> <p>KEL-DPZ-CLICK series</p> <p>140 – 141</p>	 <p>IP64</p> <p>Cable entry plates for plug-in assembly without tools</p> <p>KEL-DP series</p> <p>142 – 147</p>
 <p>IP65</p> <p>Cable entry plates, round plug-in mounting, M20 – M50</p> <p>KEL-DP round series</p> <p>148 – 150</p>	 <p>Plugs for membranes and multi-range cable grommets</p> <p>ST-B</p> <p>151</p>	 <p>Cover plugs for cable entry plates</p> <p>152</p>
 <p>IP68</p> <p>Cable entry plates for screw-in or snap-in assembly, high strain relief</p> <p><i>Hygienic Design Line</i></p> <p>KEL-DPU-HD</p> <p>350 – 351</p>	 <p>IP68</p> <p>Cable entry plates, round with thread and locknut M32 – M63</p> <p><i>Hygienic Design Line</i></p> <p>KEL-DPZ-HD round</p> <p>352 – 353</p>	 <p>Thread extension for cable glands and cable entry plates M32, M50, M63</p> <p>TE-M</p> <p>290 – 291</p>

Heavy-duty cable entry plates with IP66/IP68 rating
KEL-DPU

KEL-DPU entry plates are designed to route and seal cables without connectors (from 3.2 mm to 20.5 mm in diameter) in limited space with IP66/IP68**/up to UL type 4X ratings. The KEL-DPU is particularly characterised by its solid robust frame and the increased strain relief of the routed cables.

The KEL-DPU 24 matches exactly the cut-out dimensions of 24-pin standard industrial connectors. For optional screw assembly just pierce the membranes on the integrated screw holes with the screw itself.

The assembly of the KEL-DPU with cables or pneumatic hoses can be done quick and easy. Simply make a small hole in the thin membrane and push the cables through. ST-B Plugs can be used for sealing pierced membranes if cables have been removed.

The version with threaded bushings enables the cable entry plate to be screwed onto the housing from the inside out. This protects against vandalism and tampering with the housing from the outside.

Advantages & benefits

- Dual cable sealing with IP66/IP68**/up to UL type 4X
- Snap or screw mounting possible
- High strength and stability
- High strain relief
- Fast and easy assembly
- Very high cable density
- For industrial standard cut-outs
- Hygienic design – free of dirt-collecting recesses



Membrane on front



Conical shape on back provides additional sealing and strain relief

i This product range is also available as a KEL-DPU-HD version for the food sector, see pages 350 – 351. Single-piece packaging units are available on request.

KEL-DPU Heavy-duty cable entry plates with high strain relief
KEL-DPU 24

Specifications

Material	Frame: Polypropylene (PP) Sealing plate: Elastomer
Colour	■ grey (similar RAL 7035) ■ black
Flame class	UL 94 V-0, self-extinguishing
IP rating	IP66/IP67/IP68 (certified acc. to EN 60529)
UL type rating	UL type 12 (acc. to UL 50E) UL type 4X (acc. to UL 50E)
Temperature	-40°C to +100°C (static)
Properties	Halogen-free, silicone-free
Plate depth	14 mm
For wall thickness	1.5 – 2 mm (snap-in mounting)

Accessories

ST-B Plugs	151
KEL-EMC-PF Cable collectors	225
FP Flanged plates	276 - 285



Resistant against industrial detergents (ECOLAB certified)



ST-B plug for the sealing of the perforated membrane



Also available in black



Tool-free assembly possible due to snap-in function



Also available with threaded bushings

KEL-DPU
Heavy-duty cable entry plates
with high strain relief
KEL-DPU 24

IP66 IP68



Description	Cut-out Drilling template	Type	Cut-out mm	Number of cables	Order No.	PU
		KEL-DPU 24 13	36 x 112 mm	10x 3.2 - 6.3 mm 3x 16 - 20.5 mm	■ 43940 ■ 50940	10
		KEL-DPU 24 13 with threaded bushings M4	36 x 112 mm		■ 43940.400 ■ 50940.400	10
		KEL-DPU 24 14	36 x 112 mm	5x 3.2 - 6.3 mm 2x 4 - 7.5 mm 3x 5.5 - 10.5 mm 1x 8 - 12.5 mm 3x 12 - 16.2 mm	■ 43944 ■ 50944	10
		KEL-DPU 24 14 with threaded bushings M4	36 x 112 mm		■ 43944.400 ■ 50944.400	10
		KEL-DPU 24 16	36 x 112 mm	8x 3.2 - 5.5 mm 6x 5 - 8.5 mm 2x 9.5 - 14.5 mm	■ 43936 ■ 50936	10
		KEL-DPU 24 16 with threaded bushings M4	36 x 112 mm		■ 43936.400 ■ 50936.400	10
		KEL-DPU 24 16-1	36 x 112 mm	2x 3.2 - 6.3 mm 9x 4 - 7.5 mm 1x 5.5 - 10.5 mm 1x 8 - 12.5 mm 3x 12 - 16.2 mm	■ 43932 ■ 50932	10
		KEL-DPU 24 16-1 with threaded bushings M4	36 x 112 mm		■ 43932.400 ■ 50932.400	10



Also available in black

i This product range is also available as a KEL-DPU-HD version for the food sector, see pages 350 – 351. Single-piece packaging units are available on request.

KEL-DPU
Heavy-duty cable entry plates
with high strain relief
KEL-DPU 24

IP66 IP68



Description	Cut-out Drilling template	Type	Cut-out mm	Number of cables	Order No.	PU
		KEL-DPU 24 17	36 x 112 mm	4x 3.2 - 6.3 mm 2x 4 - 7.5 mm 1x 5.5 - 10.5 mm 10x 8 - 12.5 mm	■ 43934 ■ 50934	10
		KEL-DPU 24 17 with threaded bushings M4	36 x 112 mm		■ 43934.400 ■ 50934.400	10
		KEL-DPU 24 20	36 x 112 mm	12x 3.2 - 5.5 mm 8x 5 - 10.5 mm	■ 43938 ■ 50938	10
		KEL-DPU 24 20 with threaded bushings M4	36 x 112 mm		■ 43938.400 ■ 50938.400	10
		KEL-DPU 24 21	36 x 112 mm	1x 3.2 - 6.3 mm 14x 4 - 7.5 mm 4x 5.5 - 10.5 mm 2x 8 - 12.5 mm	■ 43930 ■ 50930	10
		KEL-DPU 24 21 with threaded bushings M4	36 x 112 mm		■ 43930.400 ■ 50930.400	10
		KEL-DPU 24 32	36 x 112 mm	32x 3.2 - 6.3 mm	■ 43942 ■ 50942	10
		KEL-DPU 24 32 with threaded bushings M4	36 x 112 mm		■ 43942.400 ■ 50942.400	10



Cable entry plates with IP66 rating KEL-DPZ series

KEL-DPZ cable entry plates are designed to route and seal a large number of cables without connectors, hoses or fibre optics (from 2.5 mm to 22 mm in diameter) in limited space. The KEL-DPZ products are a cost and time saving alternative to traditional cable glands.

The assembly of the KEL-DPZ with cables or pneumatic hoses can be done quick and easy. Simply make a small hole in the thin membrane, push the cables through. The KEL-DPZ provides strain relief and protection up to IP66/UL type 12.

The KEL-DPZ matches exactly the cut-out dimensions of 6-, 10- 16- and 24-pin standard industrial connectors. The size KEL-DPZ-B fits on cut-outs 46 x 46 mm. The very compact size KEL-DPZ-E is designed for routing cables in very small space. Through a cut-out of only 18 x 112 mm, up to 21 cables can be easily routed and sealed.

Especially for Rittal KL and KX terminal boxes the size KEL-DPZ-KX/KL was created. It was designed for routing up to 72 cables through the pre-cut standard cut-out. The self-tapping screws (M4) required for assembly are included in the scope of delivery. ST-B Plugs can be used for sealing pierced membranes if cables have been removed.

The version with threaded bushings enables the cable entry plate to be screwed onto the housing from the inside out. This protects against vandalism and tampering with the housing from the outside.

Advantages & benefits

- Dual sealing acc. to IP65/IP66/UL type 12
- Fast and easy assembly
- High cable density
- High strain relief
- Hygienic design

Specifications

Material	Frame: Polyamide (PA) Stainless steel V2A: KEL-DPZ 6 + KEL-DPZ-KX/KL
Colour	Sealing plate: Elastomer ■ grey (similar RAL 7035) ■ black
Flame class	UL 94 V-0, self-extinguishing
IP rating	IP65/IP66 (certified acc. to EN 60529)
UL type rating	UL type 12 (acc. to UL 50E)
Temperature	- 40°C to + 100°C (static)
Properties	Halogen-free, silicone-free
Plate depth	14 mm

Accessories

ST-B Plugs	151
KEL-EMC-PF Cable collectors	225
FP Flanged plates	276 - 285



Also available in black



Also available with threaded bushings



Membrane on front



Conical shape on back provides additional sealing and strain relief

KEL-DPZ Cable entry plates KEL-DPZ 24



Description	Cut-out Drilling template	Type	Cut-out mm	Number of cables	Order No.	PU
		KEL-DPZ 24 14	36 x 112 mm	10x 3.2 - 6.5 mm 4x 16 - 22 mm	■ 43700 ■ 50700	10
		KEL-DPZ 24 14 with threaded bushings M4	36 x 112 mm	10x 3.2 - 6.5 mm 4x 16 - 22 mm	■ 43700.400 ■ 50700.400	10
		KEL-DPZ 24 15	36 x 112 mm	15x 7.2 - 12 mm	■ 43720 ■ 50720	10
		KEL-DPZ 24 15 with threaded bushings M4	36 x 112 mm	15x 7.2 - 12 mm	■ 43720.400 ■ 50720.400	10
		KEL-DPZ 24 16	36 x 112 mm	8x 3.2 - 6.5 mm 4x 5 - 9.7 mm 2x 9 - 16.2 mm 2x 16 - 22 mm	■ 43725 ■ 50725	10
		KEL-DPZ 24 16 with threaded bushings M4	36 x 112 mm	8x 3.2 - 6.5 mm 4x 5 - 9.7 mm 2x 9 - 16.2 mm 2x 16 - 22 mm	■ 43725.400 ■ 50725.400	10
		KEL-DPZ 24 17	36 x 112 mm	6x 3.2 - 6.5 mm 6x 5 - 10.2 mm 5x 9 - 16.2 mm	■ 43705 ■ 50705	10
		KEL-DPZ 24 17 with threaded bushings M4	36 x 112 mm	6x 3.2 - 6.5 mm 6x 5 - 10.2 mm 5x 9 - 16.2 mm	■ 43705.400 ■ 50705.400	10
		KEL-DPZ 24 25	36 x 112 mm	12x 3.2 - 6.5 mm 7x 4.8 - 9.7 mm 6x 7.5 - 12 mm	■ 43710 ■ 50710	10
		KEL-DPZ 24 25 with threaded bushings M4	36 x 112 mm	12x 3.2 - 6.5 mm 7x 4.8 - 9.7 mm 6x 7.5 - 12 mm	■ 43710.400 ■ 50710.400	10
		KEL-DPZ 24 26	36 x 112 mm	26x 5.0 - 10.2 mm	■ 43711 ■ 50711	10
		KEL-DPZ 24 26 with threaded bushings M4	36 x 112 mm	26x 5.0 - 10.2 mm	■ 43711.400 ■ 50711.400	10

i The KEL-DPZ series is also available as a cleanroom version, see from page 337. Single-piece packaging units are available on request.

KEL-DPZ
Cable entry plates
KEL-DPZ 24

KEL-DPZ
Cable entry plates
KEL-DPZ 16

IP66



IP66



Type	Cut-out Drilling template	Type	Cut-out mm	Number of cables	Order No.	PU
		KEL-DPZ 24 32	36 x 112 mm	21x 3.2 - 6.5 mm 8x 5 - 10.2 mm 3x 7.5 - 12 mm	43730 50730	10
		KEL-DPZ 24 32 with threaded bushings M4	36 x 112 mm	21x 3.2 - 6.5 mm 8x 5 - 10.2 mm 3x 7.5 - 12 mm	43730.400 50730.400	10
		KEL-DPZ 24 42	36 x 112 mm	42x 3.2 - 6.5 mm	43715 50715	10
		KEL-DPZ 24 42 with threaded bushings M4	36 x 112 mm	42x 3.2 - 6.5 mm	43715.400 50715.400	10
		KEL-DPZ 24 121	36 x 112 mm	119x 1.5 - 2.6 mm 2x 2.5 - 5 mm	43735 50735	10
		KEL-DPZ 24 121 with threaded bushings M4	36 x 112 mm	119x 1.5 - 2.6 mm 2x 2.5 - 5 mm	43735.400 50735.400	10

* Only valid for grey product types



High cable density



KEL-DPZ 16

Type	Cut-out Drilling template	Type	Cut-out mm	Number of cables	Order No.	PU
		KEL-DPZ 16 11	36 x 86 mm	11x 7.5 - 12 mm	43815	10
		KEL-DPZ 16 11 with threaded bushings M4	36 x 86 mm	11x 7.5 - 12 mm	43815.400	10
		KEL-DPZ 16 14	36 x 86 mm	5x 3.2 - 6.5 mm 5x 5 - 10.2 mm 4x 9 - 16.2 mm	43816	10
		KEL-DPZ 16 14 with threaded bushings M4	36 x 86 mm	5x 3.2 - 6.5 mm 5x 5 - 10.2 mm 4x 9 - 16.2 mm	43816.400	10
		KEL-DPZ 16 20	36 x 86 mm	11x 3.2 - 6.5 mm 5x 5 - 10.2 mm 4x 7.5 - 12 mm	43817	10
		KEL-DPZ 16 20 with threaded bushings M4	36 x 86 mm	11x 3.2 - 6.5 mm 5x 5 - 10.2 mm 4x 7.5 - 12 mm	43817.400	10
		KEL-DPZ 16 25	36 x 86 mm	16x 3.2 - 6.5 mm 6x 5 - 10.2 mm 3x 7.5 - 12 mm	43818	10
		KEL-DPZ 16 25 with threaded bushings M4	36 x 86 mm	16x 3.2 - 6.5 mm 6x 5 - 10.2 mm 3x 7.5 - 12 mm	43818.400	10
		KEL-DPZ 16 34	36 x 86 mm	34x 3.2 - 6.5 mm	43819	10
		KEL-DPZ 16 34 with threaded bushings M4	36 x 86 mm	34x 3.2 - 6.5 mm	43819.400	10

i The KEL-DPZ series is also available as a cleanroom version, see from page 337. Single-piece packaging units are available on request.

KEL-DPZ
Cable entry plates
KEL-DPZ 10

KEL-DPZ
Cable entry plates
KEL-DPZ 6

IP66



IP66



Type	Cut-out Drilling template	Type	Cut-out mm	Number of cables	Order No.	PU
		KEL-DPZ 10 8	65 x 36 mm	8 x 7.5 - 12 mm	43800	10
		KEL-DPZ 10 8 with threaded bushings M4	65 x 36 mm	8 x 7.5 - 12 mm	43800.400	10
		KEL-DPZ 10 14	65 x 36 mm	14 x 5 - 10.2 mm	43801	10
		KEL-DPZ 10 14 with threaded bushings M4	65 x 36 mm	14 x 5 - 10.2 mm	43801.400	10
		KEL-DPZ 10 15	65 x 36 mm	5 x 3.2 - 6.5 mm 10 x 5 - 10.2 mm	43802	10
		KEL-DPZ 10 15 with threaded bushings M4	65 x 36 mm	5 x 3.2 - 6.5 mm 10 x 5 - 10.2 mm	43802.400	10
		KEL-DPZ 10 16	65 x 36 mm	9 x 3.2 - 6.5 mm 4 x 5 - 10.2 mm 3 x 7.5 - 12 mm	43803	10
		KEL-DPZ 10 16 with threaded bushings M4	65 x 36 mm	9 x 3.2 - 6.5 mm 4 x 5 - 10.2 mm 3 x 7.5 - 12 mm	43803.400	10
		KEL-DPZ 10 26	65 x 36 mm	26 x 3.2 - 6.5 mm	43804	10
		KEL-DPZ 10 26 with threaded bushings M4	65 x 36 mm	26 x 3.2 - 6.5 mm	43804.400	10

Type	Cut-out Drilling template	Type	Cut-out mm	Number of cables	Order No.	PU
		KEL-DPZ 6 12	52 x 36 mm	12 x 4.5 - 8.0 mm	43809	10
		KEL-DPZ 6 18-1	52 x 36 mm	6 x 2.5 - 5.0 mm 5 x 3.2 - 6.5 mm 7 x 4.5 - 8.0 mm	43811	10
		KEL-DPZ 6 18	52 x 36 mm	18 x 3.2 - 6.5 mm	43812	10
		KEL-DPZ 6 23	52 x 36 mm	13 x 2.5 - 5.0 mm 10 x 3.2 - 6.5 mm	43813	10
		KEL-DPZ 6 27	52 x 36 mm	27 x 2.5 - 5.0 mm	43814	10



Single-piece packaging units are available on request.

KEL-DPZ
Cable entry plates
KEL-DPZ-B



Type	Cut-out Drilling template	Type	Cut-out mm	Number of cables	Order No.	PU
		KEL-DPZ-B 13	46 x 46 mm	8× 3.2 - 6.5 mm 4× 5 - 10.2 mm 1× 16 - 22 mm	■ 43794 ■ 50794	10
		KEL-DPZ-B 13 with threaded bushings M4	46 x 46 mm	8× 3.2 - 6.5 mm 4× 5 - 10.2 mm 1× 16 - 22 mm	■ 43794.400 ■ 50794.400	10
		KEL-DPZ-B 17	46 x 46 mm	10× 3.2 - 6.5 mm 4× 5 - 10.2 mm 2× 7.5 - 12 mm 1× 9 - 16.2 mm	■ 43796 ■ 50796	10
		KEL-DPZ-B 17 with threaded bushings M4	46 x 46 mm	10× 3.2 - 6.5 mm 4× 5 - 10.2 mm 2× 7.5 - 12 mm 1× 9 - 16.2 mm	■ 43796.400 ■ 50796.400	10
		KEL-DPZ-B 25	46 x 46 mm	25× 3.2 - 6.5 mm	■ 43798 ■ 50798	10
		KEL-DPZ-B 25 with threaded bushings M4	46 x 46 mm	25× 3.2 - 6.5 mm	■ 43798.400 ■ 50798.400	10

KEL-DPZ
Cable entry plates
KEL-DPZ-E, KEL-DPZ-KX/KL



Type	Cut-out Drilling template	Type	Cut-out mm	Number of cables	Order No.	PU
		KEL-DPZ-E 112 7	18 x 112 mm	7× 7.5 - 12 mm	■ 43780 ■ 50780	10
		KEL-DPZ-E 112 7 with threaded bushings M4	18 x 112 mm	7× 7.5 - 12 mm	■ 43780.400 ■ 50780.400	10
		KEL-DPZ-E 112 21	18 x 112 mm	21× 3.2 - 6.5 mm	■ 43790 ■ 50790	10
		KEL-DPZ-E 112 21 with threaded bushings M4	18 x 112 mm	21× 3.2 - 6.5 mm	■ 43790.400 ■ 50790.400	10
		KEL-DPZ-KX/KL 72	62 x 192 mm	42× 3.2 - 6.5 mm 21× 5 - 10.2 mm 6× 9 - 16.2 mm 3× 16 - 22 mm	■ 43675.001 ■ 43675.101	1



ST-B plug for the sealing of the perforated membrane

i The KEL-DPZ series is also available as a cleanroom version, see from page 337. Single-piece packaging units are available on request.

i The KEL-DPZ series is also available as a cleanroom version, see from page 337. Single-piece packaging units are available on request.

Cable entry plates with IP66/IP68 rating
KEL-DPZ round series

KEL-DPZ round
Cable entry plates

KEL-DPZ round cable entry plates are designed to route and seal cables without connectors or fibre optics (from 1.5 mm to 22 mm in diameter) in limited space.

The assembly of the KEL-DPZ round with cables or pneumatic hoses can be done quick and easy. Simply make a small hole in the thin membrane, push the cables through. The KEL-DPZ round provides strain relief and protection IP66/IP68/UL Type 4X.

The round versions of the KEL-DPZ series have a thread to fit in metric cut-outs from M25 to M63. Thus cut-outs for metric cable glands can be used. ST-B Plugs can be used for sealing pierced membranes if cables have been removed.

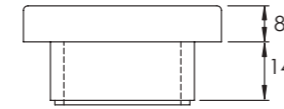

Advantages & benefits

- Dual sealing of cables acc. to IP66/IP68/up to UL type 4X
- Quick and easy tool-free assembly
- High cable density
- High strain relief
- Suitable for metric cut-outs
- Polyamide locknuts are included in the shipment
- Hygienic design – free of dirt-collecting recesses
- Available as an FDA compliant version

Specifications

Material	Thread frame: Polyamide (PA) Sealing plate: Elastomer
Colour	■ grey (similar RAL 7035) ■ black
Flame class	UL 94 V-0, self-extinguishing
IP rating	IP65/IP66/IP67/IP68 (certified acc. to EN 60529)
UL type rating	UL type 12 (acc. to UL 50E) UL type 4X (acc. to UL 50E)
Temperature	-40°C to +100°C (static)
Properties	Halogen-free, silicone-free
Cut-out dim.	Metric sizes
Thread length	14 mm
Plate depth	8 mm



Membrane on front



Conical shape on back provides additional sealing and strain relief



Also available in black

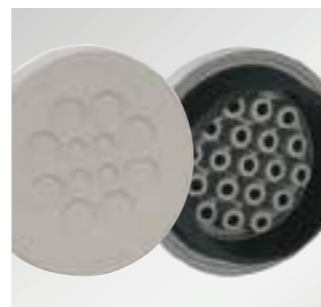

Accessories

ST-B Plugs	151
FP Flanged plates	276 - 285
MP Module plates	270 - 271

i This product range is also available as a KEL-DPZ-HD version for the food sector, see pages 352 – 353.
The KEL-DPZ round is also available as a cleanroom version, see from page 340.
Single-piece packaging units are available on request.



Can be combined with TE-M thread extension



ST-B plug for the sealing of the perforated membrane

Type	Order No.	Number of cables	Thread metric	Thread length	Max. wall thickness	External diameter	Mounting height	PU
KEL-DPZ 25 3	■ 43736	2× 3.2 - 5.2 mm 1× 3.2 - 6.5 mm	M25 × 1.5	14 mm	7.0 mm	39 mm	8 mm	10
	■ 50736							
KEL-DPZ 25 4	■ 43737	4× 3.2 - 5.2 mm	M25 × 1.5	14 mm	7.0 mm	39 mm	8 mm	10
	■ 50737							
KEL-DPZ 32 4	■ 43732	3× 3.2 - 6.5 mm 1× 7.2 - 12.5 mm	M32 × 1.5	14 mm	7.0 mm	44 mm	8 mm	10
	■ 50732							
KEL-DPZ 32 4-2	■ 43733	4× 5 - 9.5 mm	M32 × 1.5	14 mm	7.0 mm	44 mm	8 mm	10
	■ 50733							
KEL-DPZ 32 7	■ 43734	7× 3.2 - 6.5 mm	M32 × 1.5	14 mm	7.0 mm	44 mm	8 mm	10
	■ 50734							
KEL-DPZ 40 8	■ 43741	4× 3.2 - 6.5 mm 4× 5 - 10.2 mm	M40 × 1.5	14 mm	7.0 mm	52 mm	8 mm	10
	■ 50741							
KEL-DPZ 50 8	■ 43750	5× 5 - 10.2 mm 3× 7.2 - 12.5 mm	M50 × 1.5	14 mm	6.0 mm	62 mm	8 mm	10
	■ 50750							
KEL-DPZ 50 10	■ 43751	7× 3.2 - 6.5 mm 2× 5 - 10.2 mm 1× 16 - 22.2 mm	M50 × 1.5	14 mm	6.0 mm	62 mm	8 mm	10
	■ 50751							
KEL-DPZ 50 12	■ 43752	4× 3.2 - 6.5 mm 8× 5 - 10.2 mm	M50 × 1.5	14 mm	6.0 mm	62 mm	8 mm	10
	■ 50752							
KEL-DPZ 50 19	■ 43758	19× 3.2 - 6.5 mm	M50 × 1.5	14 mm	6.0 mm	62 mm	8 mm	10
	■ 50758							
KEL-DPZ 50 78	■ 43756	76× 1.5 - 2.6 mm 2× 2.5 - 5 mm	M50 × 1.5	14 mm	6.0 mm	62 mm	8 mm	10
	■ 50756							
KEL-DPZ 63 9	■ 43760	1× 3.2 - 6.5 mm 3× 5 - 10.2 mm 4× 9 - 16.2 mm 1× 16 - 22.2 mm	M63 × 1.5	14 mm	6.0 mm	75 mm	8 mm	10
	■ 50760							
KEL-DPZ 63 13	■ 43761	4× 3.2 - 6.5 mm 4× 5 - 10.2 mm 5× 9 - 16.2 mm	M63 × 1.5	14 mm	6.0 mm	75 mm	8 mm	10
	■ 50761							
KEL-DPZ 63 14	■ 43762	14× 5 - 10.2 mm	M63 × 1.5	14 mm	6.0 mm	75 mm	8 mm	10
	■ 50762							
KEL-DPZ 63 35	■ 43763	35× 3.2 - 6.5 mm	M63 × 1.5	14 mm	6.0 mm	75 mm	8 mm	10
	■ 50763							

*4X for indoor use only

Cable entry plates
for snap-in or screw-in assembly
with IP65/IP66/IP68 rating
KEL-DPZ-CLICK series

The round cable entry plates KEL-DPZ-CLICK are designed to route and seal cables without connectors or fibre optics (from 1.5 mm to 22 mm in diameter) in limited space.

The new variant of the proven cable entry plate KEL-DPZ is snapped into the cut-out directly from the front. This significantly reduces the assembly time. Alternatively, the new variant can be fastened with a lock nut to achieve protection class IP66/IP68. The KEL-DPZ-CLICK series have a thread to fit in metric cut-outs from M25 to M63. Thus cut-outs for metric cable glands can be used. A lock nut is not included in the shipment.

Snap-in assembly:
For wall thickness 1 – 2.5 mm
Protection class IP65

Screwed in place with a lock nut:
For max. wall thickness 11 mm
Protection class IP66/IP68

Advantages & benefits

- Easy assembly directly from the front
- Offers two mounting types:
Snap in (IP65) and Screw in (up to IP68)
- Certified protection IP65/IP66/IP68 (acc. to EN 60529)
- High cable density
- Automatic sealing and strain relief for the cable
- Suitable for metric cut-outs M25 – M63
- Snap-in assembly: For wall thickness 1.0 – 2.5 mm
- Screw assembly: For wall thickness up to 11 mm

Specifications

Material	Polyamid, Elastomere
IP rating	Snap-in: IP65 Screwed in place with lock nut: IP65/IP66/IP68
Flame class	UL 94 V-0, self-extinguishing
Temperature	-40°C to +100°C (static)
Colour	■ grey (similar to RAL 7035)
Properties	Halogen free, silicone free
Mounting height	8 mm

Accessories

KGM locknuts 292



Mounting type 1:
Snap into the cut-out
For wall thickness 1 – 2.5 mm

Mounting type 2:
Screwed in place with a lock nut
For max. wall thickness 11 mm

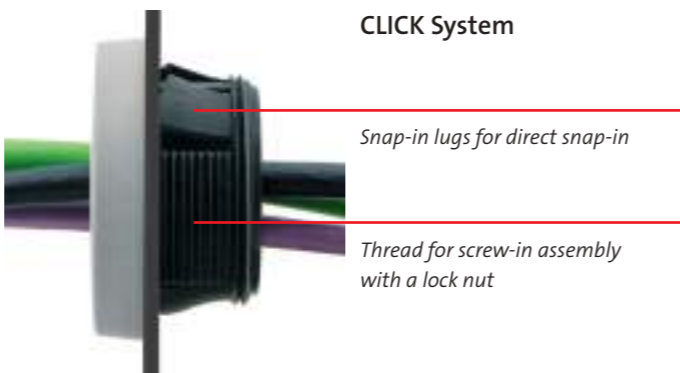
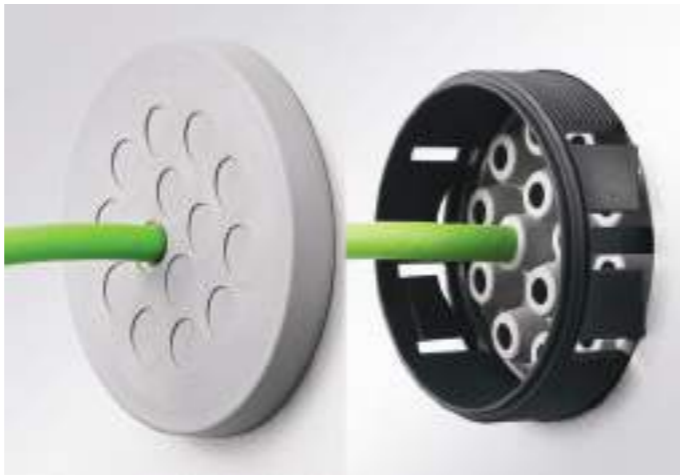

i Single-piece packaging units are available on request.

KEL-DPZ-CLICK
Cable entry plates
for snap-in or screw-in assembly

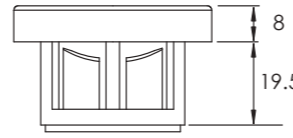

Type	Order No.	Number of cables	Thread metric	Thread length	External diameter	Mounting height	PU
KEL-DPZ-CLICK 25 3	■ 44050	2× 3.2 – 5.2 mm 1× 3.2 – 6.5 mm	M25 × 1.5	19.5 mm	39 mm	8 mm	10
KEL-DPZ-CLICK 25 4	■ 44051	4× 3.2 – 5.2 mm	M25 × 1.5	19.5 mm	39 mm	8 mm	10
KEL-DPZ-CLICK 32 4	■ 44052	3× 3.2 – 6.5 mm 1× 7.2 – 12.5 mm	M32 × 1.5	19.5 mm	44 mm	8 mm	10
KEL-DPZ-CLICK 32 4-2	■ 44053	4× 5 – 9.5 mm	M32 × 1.5	19.5 mm	44 mm	8 mm	10
KEL-DPZ-CLICK 32 7	■ 44054	7× 3.2 – 6.5 mm	M32 × 1.5	19.5 mm	44 mm	8 mm	10
KEL-DPZ-CLICK 40 8	■ 44055	4× 3.2 – 6.5 mm 4× 5 – 10.2 mm	M40 × 1.5	19.5 mm	52 mm	8 mm	10
KEL-DPZ-CLICK 50 8	■ 44056	5× 5 – 10.2 mm 3× 7.2 – 12.5 mm	M50 × 1.5	19.5 mm	62 mm	8 mm	10
KEL-DPZ-CLICK 50 10	■ 44057	7× 3.2 – 6.5 mm 2× 5 – 10.2 mm 1× 16 – 22.2 mm	M50 × 1.5	19.5 mm	62 mm	8 mm	10
KEL-DPZ-CLICK 50 12	■ 44058	4× 3.2 – 6.5 mm 8× 5 – 10.2 mm	M50 × 1.5	19.5 mm	62 mm	8 mm	10
KEL-DPZ-CLICK 50 19	■ 44059	19× 3.2 – 6.5 mm	M50 × 1.5	19.5 mm	62 mm	8 mm	10
KEL-DPZ-CLICK 50 78	■ 44060	76× 1.5 – 2.6 mm 2× 2.5 – 5 mm	M50 × 1.5	19.5 mm	62 mm	8 mm	10
KEL-DPZ-CLICK 63 9	■ 44061	1× 3.2 – 6.5 mm 3× 5 – 10.2 mm 4× 9 – 16.2 mm 1× 16 – 22.2 mm	M63 × 1.5	19.5 mm	75 mm	8 mm	10
KEL-DPZ-CLICK 63 13	■ 44062	4× 3.2 – 6.5 mm 4× 5 – 10.2 mm 5× 9 – 16.2 mm	M63 × 1.5	19.5 mm	75 mm	8 mm	10
KEL-DPZ-CLICK 63 14	■ 44063	14× 5 – 10.2 mm	M63 × 1.5	19.5 mm	75 mm	8 mm	10
KEL-DPZ-CLICK 63 35	■ 44064	35× 3.2 – 6.5 mm	M63 × 1.5	19.5 mm	75 mm	8 mm	10

2.1

Cable entry plates with IP64 rating **KEL-DP series**

KEL-DP
Cable entry plates
KEL-DP 24

KEL-DP entry plates are designed for routing cables without connectors, hoses or fibre optics in limited space.

The KEL-DP products are an easy to assemble and cost saving alternative to traditional cable glands. Simply make a small hole in the thin membrane and push the cables through. The KEL-DP provides protection IP64/UL type 12.

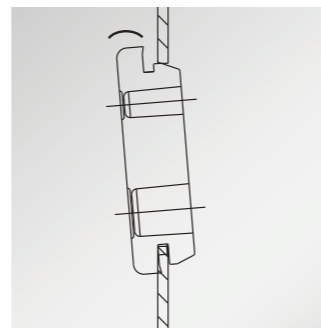

Fastening



Also available in black



IP64

The KEL-DP matches exactly the cut-out dimensions of 6-, 10-, 16- and 24-pin standard industrial connectors. The very compact size KEL-DP-E is designed for routing cables in very small space. Through a cut-out of only 18 x 112 mm, up to 21 cables can be easily routed and sealed. A special rib ensures a centred fit in the cut-outs. ST-B Plugs can be used for sealing pierced membranes if cables have been removed.

Advantages & benefits

- Fast and easy assembly, no tools required
- Very good strain relief on the cable bundle
- Very high cable density
- Cost-effective
- Hygienic design – free of dirt-collecting recesses
- For wall thickness 1.5 - 4 mm

Specifications

Material	Elastomer
Colour	■ grey (similar RAL 7035) ■ black
Flame class	UL 94 V-0, self-extinguishing
IP rating	IP64 (certified acc. to EN 60529)
UL type rating	UL type 12 (acc. to UL 50E)
Temperature	-40°C to +100°C (static)
Properties	Halogen-free, silicone-free
Plate depth	5 mm

Type A:	For wall thickness 1.5 - 2.5 mm
Type B:	For wall thickness 2.8 - 4 mm

Accessories

ST-B Plugs	151
FP Flanged plates	276 - 285

Description	Cut-out	Type	Cut-out mm	Number of cables	Order No. Type A	Order No. Type B	pU
		KEL-DP 24 12	112 x 36 mm	12x max. 15 mm	■ 43508 ■ 50508	■ 43510 ■ 50510	10
		KEL-DP 24 14	112 x 36 mm	14x max. 12.1 mm	■ 43512 ■ 50512	■ 43522 ■ 50522	10
		KEL-DP 24 17	112 x 36 mm	5x max. 10.5 mm 12x max. 12.6 mm	■ 43514 ■ 50514	■ 43523 ■ 50523	10
		KEL-DP 24 18	112 x 36 mm	4x max. 6.5 mm 5x max. 10.5 mm 5x max. 12.6 mm 4x max. 16.1 mm	■ 43515 ■ 50515	■ 43528 ■ 50528	10
		KEL-DP 24 19	112 x 36 mm	12x max. 6.5 mm 7x max. 12.1 mm	■ 43516 ■ 50516	■ 43524 ■ 50524	10
		KEL-DP 24 26	112 x 36 mm	16x max. 6.5 mm 4x max. 12.1 mm 4x max. 16.1 mm 2x ASI cables	■ 43518 ■ 50518	■ 43525 ■ 50525	10
		KEL-DP 24 42	112 x 36 mm	1x max. 4.7 mm 12x max. 5 mm 17x max. 6.4 mm 12x max. 7.2 mm	■ 43511 ■ 50511	■ 43521 ■ 50521	10
		KEL-DP 24 48	112 x 36 mm	48x max. 6.5 mm	■ 43519 ■ 50519	■ 43526 ■ 50526	10
		KEL-DP 24 50	112 x 36 mm	33x max. 5.3 mm 9x max. 6.4 mm 8x max. 8.3 mm	■ 43520 ■ 50520	■ 43527 ■ 50527	10

i Single-piece packaging units are available on request.

KEL-DP
Cable entry plates
KEL-DP 16





KEL-DP
Cable entry plates
KEL-DP 10

IP64

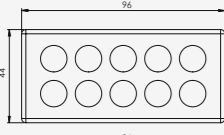
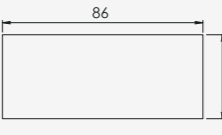
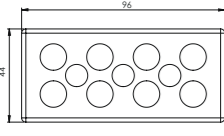
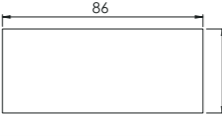
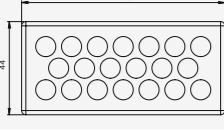

IP64

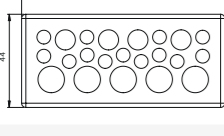
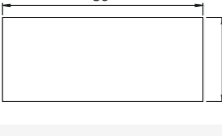
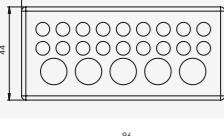
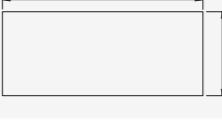
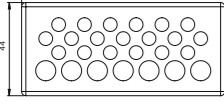

Description	Cut-out	Type	Cut-out mm	Number of cables	Art.-Nr.	PU
		KEL-DP 16 10	86 x 36 mm	10 x max. 12.1mm	43460	10
		KEL-DP 16 11	86 x 36 mm	3 x max. 10.5 mm 8 x max. 12.6 mm	43461	10
		KEL-DP 16 20	86 x 36 mm	20 x max. 8.3 mm	43462	10
		KEL-DP 16 22	86 x 36 mm	13 x max. 6.5 mm 4 x max. 8.3 mm 5 x max. 12.1 mm	43463	10
		KEL-DP 16 23	86 x 36 mm	18 x max. 6.5 mm 5 x max. 12.1 mm	43464	10
		KEL-DP 16 26	86 x 36 mm	19 x max. 6.5 mm 7 x max. 8.3 mm	43465	10

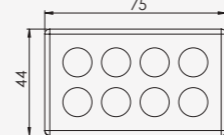
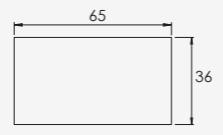
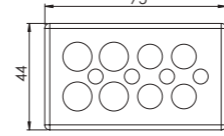
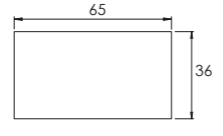
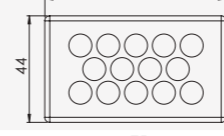
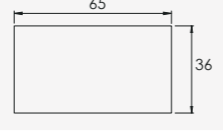
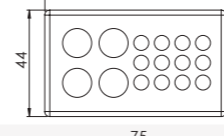
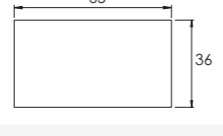
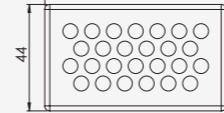
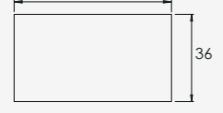
Description	Cut-out	Type	Cut-out mm	Number of cables	Art.-Nr.	PU
		KEL-DP 10 8	65 x 36 mm	8 x max. 12.6 mm	43466	10
		KEL-DP 10 12	65 x 36 mm	4 x max. 6.5 mm 4 x max. 8.3 mm 4 x max. 12.6 mm	43467	10
		KEL-DP 10 14	65 x 36 mm	14 x max. 8.3 mm	43468	10
		KEL-DP 10 16	65 x 36 mm	12 x max. 6.5 mm 4 x max. 12.6 mm	43469	10
		KEL-DP 10 26	65 x 36 mm	26 x max. 6.5 mm	43470	10



KEL-DP 16

 Single-piece packaging units are available on request.



KEL-DP 10

KEL-DP
Cable entry plates
KEL-DP 6

IP64



Description	Cut-out	Type	Cut-out mm	Number of cables	Art.-Nr.	PU
		KEL-DP 6 6	52 x 36 mm	6 x max. 12.1 mm	43450	10
		KEL-DP 6 12	52 x 36 mm	8 x max. 6.5 mm 2 x max. 12.6 mm 2 x max. 16.1 mm	43451	10
		KEL-DP 6 14	52 x 36 mm	10 x max. 6.5 mm 4 x max. 10.5 mm	43452	10
		KEL-DP 6 25	52 x 36 mm	21 x max. 5.0 mm 4 x max. 8.3 mm	43453	10

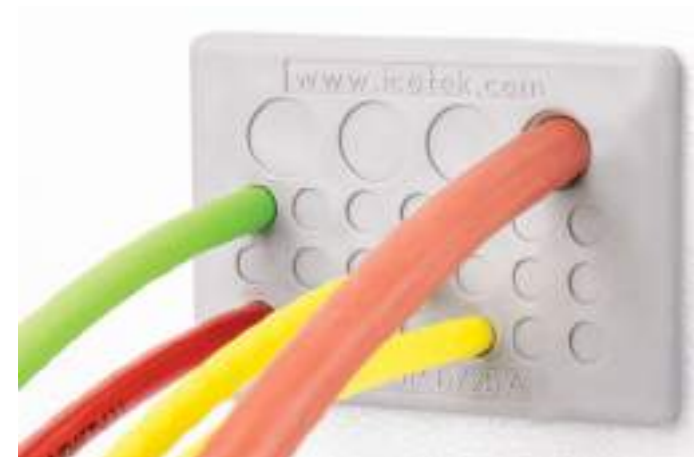

KEL-DP 6

Single-piece packaging units are available on request.

KEL-DP
Cable entry plates
KEL-DP-E



IP64

Description	Cut-out	Type	Cut-out mm	Number of cables	Art.-Nr.	PU
		KEL-DP-E 46 7	46 x 18 mm	2 x max. 6.5 mm 5 x max. 8.3 mm	43585 50585	10
		KEL-DP-E 46 9	46 x 18 mm	8 x max. 6.5 mm 1 x max. 12.1 mm	43587 50587	10
		KEL-DP-E 86 13	85 x 18 mm	2 x max. 6.5 mm 11 x max. 8.3 mm	43581 50581	10
		KEL-DP-E 86 17	85 x 18 mm	16 x max. 6.5 mm 1 x max. 12.1 mm	43583 50583	10
		KEL-DP-E 112 16	112 x 18 mm	4 x max. 6.5 mm 11 x max. 8.3 mm 1 x max. 12.1 mm	43576 50576	10
		KEL-DP-E 112 21	112 x 18 mm	16 x max. 6.5 mm 4 x max. 8.3 mm 1 x max. 12.1 mm	43578 50578	10
		KEL-DP-S 69 8	69 x 10 mm Edge radii R2	8 x max. 7.5 mm	43591 50591	10

Single-piece packaging units are available on request.

Cable entry plates with IP65 rating
KEL-DP round

KEL-DP round
Cable entry plates

KEL-DP entry plates are designed for routing cables without connectors, hoses or fibre optics in limited space.

The KEL-DP products are an easy to assemble and cost saving alternative to traditional cable glands. Simply make a small hole in the thin membrane and push the cables through. The KEL-DP round provides protection IP65/UL type 12.



Also available in black



Membrane on front

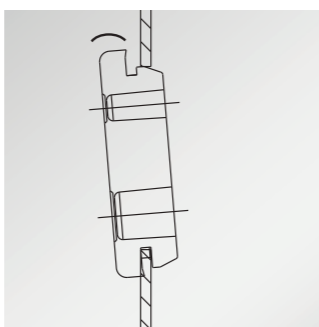

Fastening

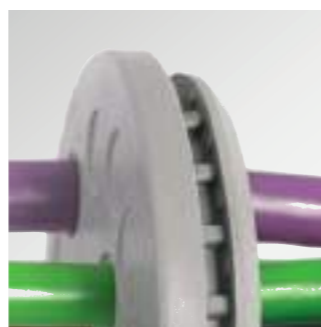

Special fixing ribs ensure a centred fit

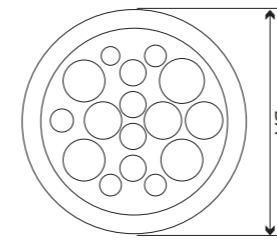

Type	Order No. Typ A	Order No. Typ B	Number of cables	Cut-out	External diameter DA	PU
KEL-DP 16 1 rund	■ 43600 ■ 50535	–	1x max. 8.0	∅ 16 mm	23 mm	10
KEL-DP 16 3 rund	■ 43601	–	3x max. 4.5	∅ 16 mm	23 mm	10
KEL-DP 16 7 rund	■ 43602	–	7x max. 3.0	∅ 16 mm	23 mm	10
KEL-DP 20 1	■ 43571	–	1x max. 14	∅ 20 mm	27 mm	10
KEL-DP 20 4	■ 43572	–	4x max. 5.2 mm	∅ 20 mm	27 mm	10
KEL-DP 20 4-1	■ 43575	–	2x max. 4.5 2x max. 8.0	∅ 20 mm	27 mm	10
KEL-DP 20 5	■ 43573	–	2x max. 3.6 mm 2x max. 4.6 mm 1x max. 10.6 mm	∅ 20 mm	27 mm	10
KEL-DP 20 9	■ 43574	–	4x max. 3.6 mm 5x max. 4.6 mm	∅ 20 mm	27 mm	10
KEL-DP 25 4	■ 43533 ■ 50533	NEW ■ 50536 ■ 43535	4x max. 8 mm	∅ 25 mm	32 mm	10
KEL-DP 25 6	■ 43531 ■ 50531	–	4x max. 5.2 mm 2x max. 9.4 mm	∅ 25 mm	32 mm	10
KEL-DP 25 7	■ 43534	–	7x max. 5.2 mm	∅ 25 mm	32 mm	10
KEL-DP 32 7	■ 43592	■ 43596	7x max. 8.0 mm	∅ 32 mm	38 mm	10
KEL-DP 32 10	■ 43532 ■ 50532	■ 43560 ■ 50560	6x max. 5.2 mm 2x max. 6.4 mm 2x max. 9.4 mm	∅ 32 mm	38 mm	10
KEL-DP 32 10-2	■ 43593	■ 43597	10x max. 6.4 mm	∅ 32 mm	38 mm	10
KEL-DP 32 11	■ 43594	■ 43598	9x max. 5.2 mm 2x max. 8.0 mm	∅ 32 mm	38 mm	10
KEL-DP 32 13	■ 43595	■ 43599	13x max. 5.2 mm	∅ 32 mm	38 mm	10

2.1 The round version of the KEL-DP fits perfectly into metric cut-outs M16 to M50. A special rib ensures a centred fit in the cut-outs.

ST-B Plugs can be used for sealing pierced membranes if cables have been removed.

Advantages & benefits

- Fast and easy assembly, no tools required
- High cable density
- Very good strain relief on the cable bundle
- Cost-effective
- For wall thickness 1.5 – 4 mm
- Hygienic design – free of dirt-collecting recesses

Specifications

Material	Elastomer
Colour	■ grey (similar RAL 7035) ■ black
Flame class	UL 94 V-0, self-extinguishing
IP rating	IP65 (certified acc. to EN 60529)
UL type rating	UL type 12 (acc. to UL 50E)
Temperature	-40°C to +100°C (static)
Properties	Halogen-free, silicone-free
Cut-out dimensions	Metric sizes
Plate depth	5 mm

Type A: For wall thickness 1.5 – 2.5 mm
Type B: For wall thickness 2.8 – 4 mm

Accessories

ST-B Plugs 151
FP Flange plates 276 - 285

Single-piece packaging units are available on request.

2.1

KEL-DP round
Cable entry plates



Type	Order No. Type A	Order No. Type B	Number of cables	Cut-out	External diameter DA	PU
KEL-DP 40 9	43536	43561	8× max. 9.5 mm 1× max. 11.3 mm	∅ 40 mm	50 mm	10
KEL-DP 40 16	43537	43563	2× max. 5.3 mm 10× max. 6.3 mm 2× max. 9.5 mm 2× max. 11.3 mm	∅ 40 mm	50 mm	10
KEL-DP 40 17	43538	43565	1× max. 4 mm 16× max. 7.2 mm	∅ 40 mm	50 mm	10
KEL-DP 50 9	43554 50554	43568 50568	5× max. 7 mm 4× max. 18 mm	∅ 50 mm	60 mm	10
KEL-DP 50 11	43555 50555	43569 50569	7× max. 7.2 mm 3× max. 11.2 mm 1× max. 22.5 mm	∅ 50 mm	60 mm	10
KEL-DP 50 12	43551 50551	43562 50562	10× max. 9.2 mm 2× max. 11.2 mm	∅ 50 mm	60 mm	10
KEL-DP 50 16	43550 50550	43564 50564	4× max. 5.3 mm 5× max. 6.3 mm 3× max. 9.5 mm 4× max. 11.3 mm	∅ 50 mm	60 mm	10
KEL-DP 50 18	43553 50553	43567 50567	2× max. 4 mm 2× max. 6 mm 4× max. 7.2 mm 5× max. 9.4 mm 5× max. 12 mm	∅ 50 mm	60 mm	10
KEL-DP 50 20	43552 50552	43566 50566	16× max. 6.3 mm 4× max. 9.3 mm	∅ 50 mm	60 mm	10
KEL-DP 50 35	43556 50556	43570 50570	35× max. 5.2 mm	∅ 50 mm	60 mm	10



ST-B
Plugs for membranes
and multi-range
cable grommets

Type	Order No.	Diameter D1	Diameter D2	Length L	PU
ST-B 5 30	42805	8 mm	5 mm	30 mm	25
ST-B 6 30	42806	9 mm	6 mm	30 mm	25
ST-B 7 30	42807	10 mm	7 mm	30 mm	25
ST-B 8 30	42808	11 mm	8 mm	30 mm	25
ST-B 9 30	42809	12 mm	9 mm	30 mm	25
ST-B 10 30	42810	13 mm	10 mm	30 mm	25
ST-B 11 30	42811	14 mm	11 mm	30 mm	25
ST-B 12 30	42812	15 mm	12 mm	30 mm	25
ST-B 13 30	42813	16 mm	13 mm	30 mm	25
ST-B 14 30	42814	17 mm	14 mm	30 mm	25
ST-B 15 30	42815	18 mm	15 mm	30 mm	25
ST-B 16 30	42816	19 mm	16 mm	30 mm	25
ST-B 17 30	42817	20 mm	17 mm	30 mm	25
ST-B 18 30	42818	21 mm	18 mm	30 mm	25
ST-B 19 30	42819	22 mm	19 mm	30 mm	25
ST-B 20 30	42820	23 mm	20 mm	30 mm	10
ST-B 21 30	42821	24 mm	21 mm	30 mm	10
ST-B 22 30	42822	25 mm	22 mm	30 mm	10
ST-B 23 30	42823	26 mm	23 mm	30 mm	10
ST-B 24 30	42824	27 mm	24 mm	30 mm	10
ST-B 25 30	42825	28 mm	25 mm	30 mm	10
ST-B 26 30	42826	29 mm	26 mm	30 mm	10
ST-B 27 30	42827	30 mm	27 mm	30 mm	10
ST-B 28 30	42828	31 mm	28 mm	30 mm	10
ST-B 29 30	42829	32 mm	29 mm	30 mm	10
ST-B 30 30	42830	33 mm	30 mm	30 mm	10
ST-B 31 30	42831	34 mm	31 mm	30 mm	10
ST-B 32 30	42832	35 mm	32 mm	30 mm	10
ST-B 33 30	42833	36 mm	33 mm	30 mm	10
ST-B 34 30	42834	37 mm	34 mm	30 mm	10

The ST-B plugs are used to seal perforated membranes of the cable entry plates (KEL-DPU, KEL-DPZ, KEL-DP, KEL-QTA), DT grommets and, in particular, the KTMBs and QTMB multi-range cable grommets. This means that entries that are no longer required can be closed. The protection rating of the cable entry remains unchanged.

The new generation of ST-B plugs has a uniform length of 30 mm to prevent the plugs from slipping out.

Advantages & benefits

- Sealing of perforated cable entry membranes which are no longer in use
- For sealing unused cable grommets

Specifications

Material	Polyamide (PA), white
Flame class	UL 94 V-0, self-extinguishing
Temperature	-40°C to +120°C
Properties	Halogen-free, silicone-free

Compatible with

KEL-DPU Cable entry plates	127 - 129
KEL-DPZ Cable entry plates	130 - 141
KEL-DP Cable entry plates	142 - 150
KT-DT Cable entry grommets	76
KEL-QTA Cable entry plates	104 - 105
KTMBs multi-range cable grommets	70 - 71
QTMB multi-range cable grommets	109

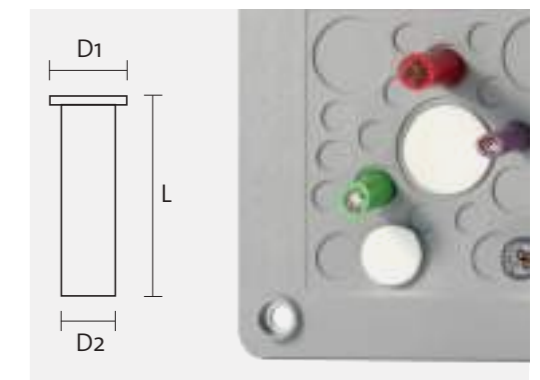

Single-piece packaging units are available on request.

Cover plugs for cable entry plates

The openings at the fastening points of the cable entry plates can be closed with the cover plugs.

The cover plugs can be used with the products of the KEL-DPZ series. They are available in black and grey.

Advantages & benefits

- Simple closing of the openings at the fastening points of the KEL-DPZ
- Smooth finish on the frame surface
- No dirt recesses

Specifications

Material	PE (Polyethylen)
Temperature	Continuous operating temperature +70°C
Properties	Higher chemical resistance

Description	Order No.	PU
Cover plugs B black for M5 DIN 912 Screws, for KEL-DPZ	■ 99200	40
Cover plugs C grey for M5 DIN 912 Screws, for KEL-DPZ	■ 99201	40

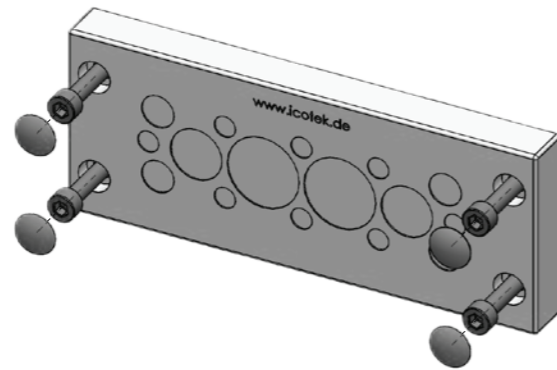

When fastening from the front by means of screws, the openings at the screw heads can be closed with the **cover plugs B** in black (order no. 99200) or **cover plugs C** in grey (order no. 99201). The cover plugs can only be used for M5 DIN 912 screws.



Made in
Germany

Free
product samples

Customer
service

No minimum
order value

Custom
projects

Global
shipping

Certified
products

Having trouble finding a solution?
icotek can develop a solution for
your individual needs.

Contact us: pm@icotek.com

2.2 Flexible cable entry grommets for cables without connectors



Fast and easy, partially tool-free assembly

High flexibility when routing rigid cables

Up to IP66/IP68 rated protection

Compact, space-saving design

For metric cut-outs M25 – M85 (KEL-DPF)

Easy peeling of the membrane rings. The peeled-off area is always round and thus seals the cable very well.

Due to high elasticity also suitable for routing preassembled cable lugs/terminals.



Cable entry plates
for screw-in assembly, M25 – M63,
for cable diameters up to 36 mm
KEL-SCDP-TR

156 – 157



Cable entry plates
for plug-in assembly, M25 – M85,
for cable diameters up to 36 mm
KEL-SCDP / KEL-SCDP-RW

158 – 159



Cable entry grommets
for screw-in assembly, M25 – M85,
for cable diameters up to 70 mm
KEL-DPF

160 – 161



Cable entry grommets
for screw-in assembly,
for cable diameters up to 115 mm
KEL-ULTRA flex

162

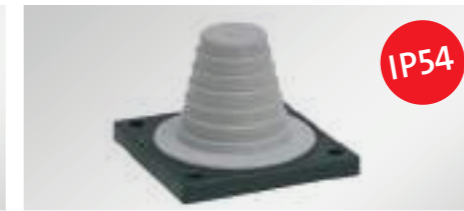

Cable entry grommets
for screw-in assembly,
for cable diameters up to 68 mm
KEL-JUMBO flex

163



Thread extension
for cable glands and cable entry plates
M32, M50, M63
TE-M

290 – 291

2.2

2.2

Cable entry plate for screw-in assembly with IP65 rating
KEL-SCDP-TR

With the KEL-SCDP-TR cable entry grommet, single cables, hoses, and conduits can be routed and sealed at a rating of IP65. The KEL-SCDP-TR 63|5+1 enables the routing of up to five cables at the same time.

Its unique advantage is the large sealing range. The single circular membrane can be peeled away to accommodate the specific diameter of the cable or hose. For this purpose, only a small hole between the rings needs to be pierced. Then the corresponding ring can be removed. No tooling is required to peel off the membrane. The peeled-off area is always round, ensuring a secure seal around the cable or the hose.

Due to its high elasticity, the KEL-SCDP-TR is also suitable for routing pre-assembled cable lugs.

The KEL-SCDP-TR plates have a thread to fit in metric cut-outs from M25 to M63. Thus cut-outs for metric cable glands can be used.

The KEL-SCDP-TR is screwed in place with a locknut. A matching locknut is included in the delivery.

Advantages & benefits

- Fast and secure assembly with the use of included locknut
- Very large sealing range (5 – 52 mm)
- Flexible even with rigid cables
- Metric thread (M25 – M63), suitable for metric cut-outs
- Perfect edge protection and sealing
- Circular membranes can be peeled off easily
- Locknut is included in the delivery

Specifications

Material	Plate: Elastomer Thread: Polyamide Locknut: Polyamide
Colour	grey (similar RAL 7035)
Flame class	UL 94 V-0, self-extinguishing
IP rating	IP65 (certified acc. to EN 60529)
Temperature	-40°C to +100°C (static)
Properties	Halogen-free, silicone-free
Mounting height	8 mm
Thread length	14 mm
Wall thickness	max. 7 mm (M25 – M40) max. 6 mm (M50 – M63)
Cut-out	Metric cut-out

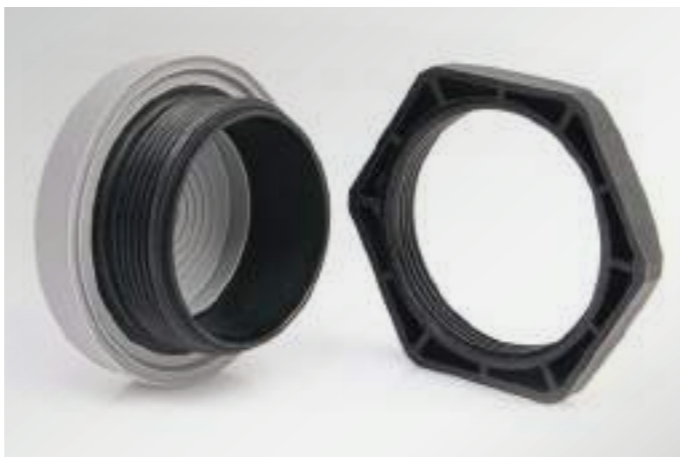

KEL-SCDP-TR Cable entry plate



Type	Order No.	Number of cables	Thread metric	Thread length	Max. wall thickness	External diameter	Mounting height	PU	
	KEL-SCDP-TR 25	44070	1x 5 – 17 mm	M25 x 1.5	14 mm	7.0 mm	39 mm	8 mm	10
	KEL-SCDP-TR 32	44071	1x 5 – 23 mm	M32 x 1.5	14 mm	7.0 mm	44 mm	8 mm	10
	KEL-SCDP-TR 40	44072	1x 8 – 28 mm	M40 x 1.5	14 mm	7.0 mm	52 mm	8 mm	10
	KEL-SCDP-TR 50	44073	1x 8 – 38 mm	M50 x 1.5	14 mm	6.0 mm	62 mm	8 mm	10
	KEL-SCDP-TR 63 1	44074	1x 8 – 52 mm	M63 x 1.5	14 mm	6.0 mm	75 mm	8 mm	10
	KEL-SCDP-TR 63 5+1	44078	5x 5 – 13 mm 1x 50 – 52 mm	M63 x 1.5	14 mm	6.0 mm	75 mm	8 mm	10



Can be combined with TE-M thread extension

Cable entry plate for plug-in assembly with IP65 rating
KEL-SCDP | KEL-SCDP-RW

With the KEL-SCDP cable entry grommet, single cables, hoses, and conduits can be routed and sealed at a rating of IP65. Its unique advantage is the large sealing range.

The single circular membrane can be peeled away to accommodate the specific diameter of the cable or hose. No tooling is required to peel off the membrane. The peeled-off area is always round, ensuring a secure seal around the cable or the hose.

Another advantage is the high mounting flexibility. The KEL-SCDP can simply be plugged into cut-outs with wall thicknesses from 1.5 to 4.0 mm.

The version KEL-SCDP-RW is approved for the use in the railway technology in accordance with EN45545-2 HL3.

Advantages & benefits

- Approved for the use in the railway technology (EN 45545-2, EN 45545-3 and EN 1363-1)
- Perfect edge protection and sealing
- Circular membranes can be peeled off easily
- Easy, tool-free assembly
- Protection class up to IP65

Specifications

Material	Elastomer
Colour	■ grey (similar RAL 7035)
Flame class	UL 94 V-0, self-extinguishing
IP rating	IP65 (certified acc. to EN 60529)
Temperature	KEL-SCDP: -40°C to +80°C (static) KEL-SCDP-RW: -40°C to +90°C (static)
Properties	Halogen-free, silicone-free



Due to high elasticity also suitable for routing preassembled cable lugs or terminals



KEL-SCDP | KEL-SCDP-RW
Cable entry plate



Type	Order No.	Number of cables	Clamping range mm	PU
KEL-SCDP 25	■ 43480	1 max.	5 – 16 mm	10
KEL-SCDP 32	■ 43481	1 max.	5 – 22 mm	10
KEL-SCDP 40	■ 43482	1 max.	8 – 28 mm	10
KEL-SCDP 50	■ 43483	1 max.	8 – 36 mm	10
KEL-SCDP-RW for the use in the railway technology				
KEL-SCDP-RW 25	■ 43490	1 max.	5 – 16 mm	10
KEL-SCDP-RW 32	■ 43491	1 max.	5 – 22 mm	10
KEL-SCDP-RW 40	■ 43492	1 max.	8 – 28 mm	10
KEL-SCDP-RW 50	■ 43493	1 max.	8 – 36 mm	10

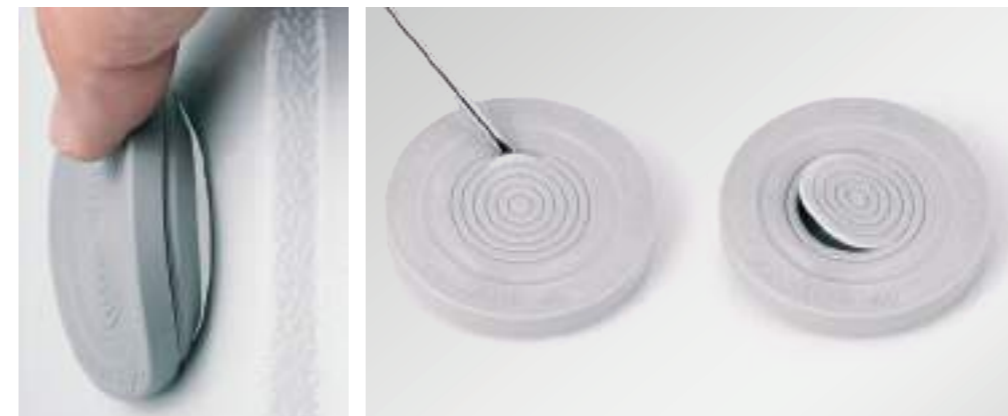

The single membrane rings are peeled off according to the diameter of the routed cable or hose. For this purpose, only a small hole between the rings needs to be pierced. Then the corresponding ring can be removed.

* Only valid for KEL-SCDP-RW

Cable entry grommet for screw-in assembly with IP66/IP68 rating KEL-DPF

The KEL-DPF was developed particularly for routing large or unknown sizes of cables into a switch cabinet or machine (max. cable diameter 70 mm). Due to the flexibility and unique pyramid shape, cable entry and flexible positioning is much easier compared to using conventional cable glands. Also perfect for bundling or restraining large cables.

Cutting of DPF grommets: Cable diameter less 20%. The corresponding diameters are marked on the grommet.

It is recommended that additional strain relief be provided for cables using cable ties.

For mounting the KEL-DPF sizes 75 and 85 we offer suitable wrenches with widths for M75 and M85 plastic locknuts.

Advantages & benefits

- Quick and tool-free assembly
- It is possible to install rigid cables at angles
- Suitable for metric cut-outs
- Polyamide locknuts are included in the shipment

Specifications

Material	Thread frame: Polyamide (PA) Pyramid: Elastomer
Colour	■ grey (similar RAL 7035) ■ black
Flame class	UL 94 V-0, self-extinguishing
IP rating	IP66/ IP68 (certified acc. to EN 60529)
UL type rating	UL type 12 (acc. to UL 50E) UL type 4X (acc. to UL 50E)
Temperature	- 40°C to + 100°C (static)
Properties	Halogen-free, silicone-free
Thread length	11 mm; KEL-DPF 85 48-70: 14 mm
Cut-out dimensions	Metric sizes

Accessories

FP Flanged plates	276 - 285
MP Module plates	270 - 271



Wrenches for M75/M85 plastic locknuts

Material: Aluminium
M75: Order No.61436 | M85: Order No. 61437 | PU: 1

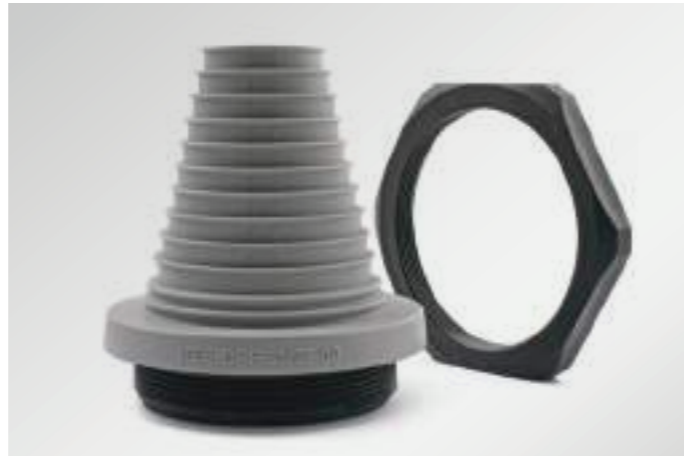



Due to high elasticity also suitable for routing preassembled cable lugs or terminals



Can be combined with TE-M thread extension

KEL-DPF Cable entry grommets

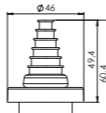
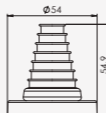
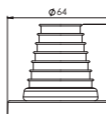
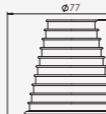
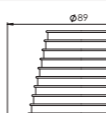

Type	Order No.	Thread metric	External diameter	Clamping range	PU
 KEL-DPF 25 3-12	■ 42652 ■ 50652	M25 × 1.5	39 mm	3 – 12 mm	5
 KEL-DPF 32 6-18	■ 42653 ■ 50653	M32 × 1.5	46 mm	6 – 18 mm	5
 KEL-DPF 40 12-27	■ 42654 ■ 50654	M40 × 1.5	54 mm	12 – 27 mm	5
 KEL-DPF 50 22-36	■ 42655 ■ 50655	M50 × 1.5	64 mm	22 – 36 mm	5
 KEL-DPF 63 27-50	■ 42656 ■ 50656	M63 × 1.5	77 mm	27 – 50 mm	5
 KEL-DPF 75 39-60	■ 42657 ■ 50657	M75 × 1.5	89 mm	39 – 60 mm	1
 KEL-DPF 85 48-70	■ 42658 ■ 50658	M85 × 2	99 mm	48 – 70 mm	1

KEL-ULTRA flex Cable entry grommets

IP66



The KEL-ULTRA flex is designed as a cable entry grommet for any large cable or conduit that is difficult to manage. The KEL-ULTRA flex comes in two sizes and is ideal for routing and sealing cables and conduits with a diameter from 25 to 115 mm. Due to the high flexibility of the elastomer pyramid, inserting large, thick cables with KEL-ULTRA flex is easier than using standard cable glands.

After inserting the cable or conduit, the KEL-ULTRA flex is quickly and easily mounted with the metal ring and screws. This ring enables a circular fixing and sealing of the grommet at the enclosure wall. The ring is supplied with each KEL-ULTRA flex. Cutting of grommets: Cable diameter less 25%. It is recommended that additional strain relief be provided for cables as part of the installation.

Advantages & benefits

- Quick assembly
- Grommets allow easy orientation and seal of rigid cables
- IP66/up to UL type 12 rating

Specifications

Material	Pyramid: Elastomer Fixing metal ring: Steel, zinc-plated Blind plate: Steel, zinc-plated
Flame class	UL 94 V-o, self-extinguishing
IP rating	IP66, when fastened with 8 screws (certified acc. to EN 60529)
UL type rating	UL type 12 (acc. to UL 50E)
Temperature	-40°C to +100°C (static)
Properties	Halogen-free, silicone-free
Cut-out dimension	Round, ϕ -cable +30%, max. ϕ 140 mm

Accessories

MP Module plates	270 - 271
BPM Blank plates	287

Description	Type	Order No.	Sealing range	PU
	KEL-ULTRA flex 1 incl. fixing screws	42630	25 - max. 90 mm cable diameter	1

	KEL-ULTRA flex 2 incl. fixing screws	42631	75 - max. 115 mm cable diameter	1
--	---	-------	------------------------------------	---



KEL-JUMBO flex Cable entry grommets

IP54



Description	Type	Order No.	Clamping range	PU
	KEL-JUMBO flex 27-48	42614	27 - 48 mm	1

	KEL-JUMBO flex 47-68	42616	47 - 68 mm	1
--	-------------------------	-------	------------	---

The KEL-JUMBO flex is a flexible cable entry grommet for cables without connectors with a diameter range from 27 – 68 mm.

They are ideal for the routing supply cables into the switch cabinets.

Cutting of KEL-JUMBO flex grommets: Cable diameter less 25%. The corresponding diameters are marked on the grommet.

It is recommended that additional strain relief be provided for cables as part of the installation.

Advantages & benefits

- Quick assembly
- Grommets allow dynamic and flexible movement of rigid cables
- Compact installation area (88 × 88 mm)

Specifications

Material	Frame: Polyamide (PA) Pyramid: Elastomer
Flame class	UL 94 V-o, self-extinguishing
IP rating	IP54
UL type rating	UL type 12 (acc. to UL 50E)
Temperature	-40°C to +100°C (static)
Properties	Halogen-free, silicone-free
Cut-out dimensions	Round, ϕ -cable +20%

Accessories

MP Module plates	270 - 271
BP Blank plates	287



3 Strain relief & cable management



Best secured and structured:
Strain relief and cable routing

By using universal icotek strain relief plates with cord grip function the user can quickly assemble, organise and strain relieve cables according to EN 62444.



Product range strain relief	Strain relief	Strain relief acc. to EN 62444	Screw assembly	Assembly on DIN rails	Assembly on C-rails	Page
CCL	■				■	168 – 169
ZL	■	■	■			170
ZL-AB / ZL-MS	■	■	■			171
ZL 03 / 04 / 05	■	■	■			172
KZL	■	■		■	■	173
SF ZL	■	■		■		174

Product range cable management	compatible with	Page
KBH-S M5	universal	179
KBH-R R MS	Rittal punched section and punched rail	179
KBH-R M G8	MiniTec with 8 mm groove	180
KBH-R M-I G8	MiniTec, Item with 8 mm groove	180
KBH-R B-R G8	Bosch Rexroth with 8 mm groove	181
KBH-R B-R G10	Bosch Rexroth with 10 mm groove	181
KBH-R I G6	Item Profil with 6 mm groove	182
KBH-R May-G8	Maytec PG40 Profil with 8 mm groove	182
KBH-R SF-M4	35 mm top hat DIN rail	183
KBH-R 12-SC	C-rails withwith an opening dimension of 16 – 17 mm	183
KBH-R 9,5	19" system punching 9.5 x 9.5 mm	183
KBH-S	23 x 23 mm mounting rail	186
KBH-SB	universal	186
KBH-R	23 x 23 mm mounting rail systems for Rittal VX25	186
KBH-RBA	drill-hole Ø 6 mm	186
KBH-RBB	drill-hole Ø 6.5 mm	186
KLKB	universal	187
KLB	universal	187

Further details on certifications and technical specifications can be found on the product pages.

3.1 systems for strain relief



Best secured and structured: Strain relief and cable routing

By using strain relief systems the user can quickly assemble, organise and provide strain relief for cables according to EN 62444. The systems can be used for organising and securing cables in machines, switch cabinets, enclosures and dynamic drag chains.

Due to the wide variety of mounting requirements, options range from top hat DIN rail snap-mount, C-rail to screw mount.

The strain relief plates are available in several sizes. The cable density can be greatly increased by using spacers for multilayer mounting. Securing the cables is done quickly and inexpensively with standard cable ties. The shape of the strain relief securely holds cable tie and cable.



Cable clamp for C-rail mount

CCL

168 – 169



Strain relief plates for screw mount

ZL

170



Strain relief plates for screw mount, with bushings

ZL-AB / ZL-MS

171



Strain relief plates for screw mount, for various cable diameters

ZL 03 | 04 | 05

172



Strain relief plates for 35 mm top hat DIN rail / C-rail snap mount

KZL

173



Strain relief plates for 35 mm top hat DIN rail snap mount

SF|ZL

174



Spacers for multilayer mounting of strain relief plates

DH

172



EMC Strain relief plates

KAFM-EMC

228



Shield plate for ZL strain relief plates

ZL|SB-EMC

229



Space-saving solution for mounting on C-rails



High cable density, multilayer mounting possible



Fast and easy, partially tool-free mounting



Wide mounting type variety: top hat DIN rail/C-rail snap mount, screw mount



Available in various sizes



Secure hold of the cable ties and cables, strain relief acc. to EN 62444

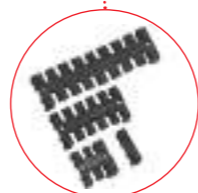

CCL Cable clamp for C-rails

The cable clamps are characterised by a high clamping range and great flexibility. Ideally suited for strain relief on the C-rail for opening dimensions 16 – 17 mm. It offers flexible clamping ranges from 6 mm to 64 mm.

The counter trough integrated in the cable clamp is secured by a locking mechanism and cannot slip out of the cable clamp under tensile load.

Advantages & benefits

- Quick and easy assembly
- Tool-free and space-saving assembly
- Large variety of clamping areas from 6 to 64 mm
- High packing density
- For mounting on all common C-rails with 16 – 17 mm opening dimensions

Specifications

Material Galvanised steel

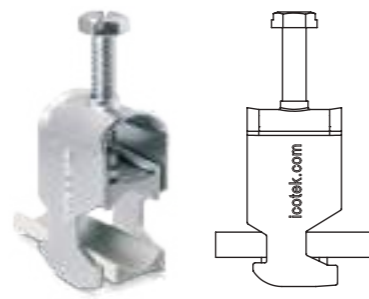

Type	Clamping range	Order No.	PU
CCL 6-13	6 – 13 mm	32000	25
CCL 12-19	12 – 19 mm	32001	25
CCL 18-23	18 – 23 mm	32002	25
CCL 22-32	22 – 32 mm	32003	25
CCL 30-38	30 – 38 mm	32004	25
CCL 38-42	38 – 42 mm	32005	25
CCL 42-50	42 – 50 mm	32006	25
CCL 50-64	50 – 64 mm	32007	25



LFC/MSKL and CCL

CCL Plastic counter trough (spare part)



Plastic counter trough (spare part)

Type	suitable for cable clamp	Order No.	PU
Counter trough Y 6/12	CCL 6-13	99215	50
Counter trough Y 12/18	CCL 12-19	99216	50
Counter trough Y 16/22	CCL 18-23	99217	50
Counter trough Y 22/38	CCL 22-32, CCL 30-38, CCL 38-42	99218	50
Counter trough Y 42/64	CCL 42-50, CCL 50-64	99219	50

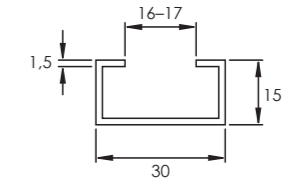

C-rail dimensions (mm)



Applications on the C-Rail with cable clamp CCL



ZL Strain relief plates for screw assembly



The strain relief plate ZL is used for static or dynamic applications for organising and securing cables on machines, control panels or drag chains.

The design of the strain relief unit provides secure strain relief according to EN 62444. Mount of the cables or pneumatic tubing is easily done using cable ties.

For multilayer installation please use DH spacers.

Advantages & benefits

- Strain relief according to EN 62444
- Easy assembly
- Cost-effective
- High cable density
- Wide variety of mounting options
- Vibration proof

Specifications

Material Polyamide (PA)
 Flame class UL 94 V-0, self-extinguishing
 Temperature -40°C to +140°C (static)
 Properties Halogen-free, silicone-free

Accessories

DH Spacers 172
 ZL|SB-EMC Shield plates 229

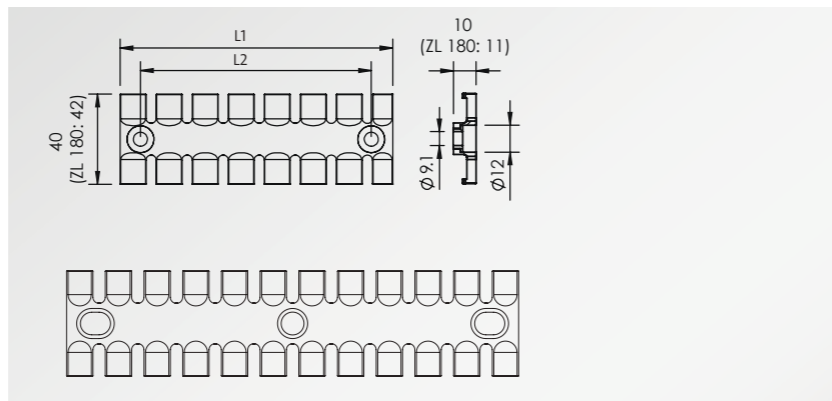

ZL 180

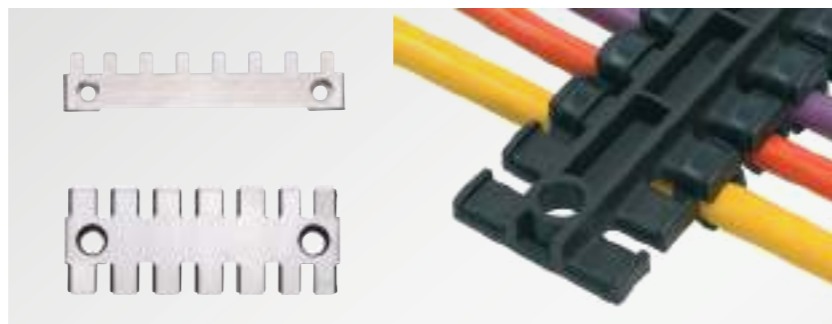

ZL|SB-EMV

ZL

Type	Order No.	Length L1	Length L2	No. of teeth	PU
ZL 39	32222	38.5 mm	19.5 mm	3	10
ZL 60	32224	59.5 mm	43.5 mm	4	10
ZL 70	32226	69.1 mm	43.5 mm	5	10
ZL 87	32228	86.5 mm	68 mm	6	10
ZL 103	32230	102.5 mm	84 mm	7	10
ZL 121	32232	121 mm	102.5 mm	8	10
ZL 140	32234	139.5 mm	121 mm	9	10
ZL 180	32236	180 mm	157 mm	12	10

ZL-AB | ZL-MS Strain relief plates for screw assembly



The strain relief plate ZL-AB / ZL-MS is used for static or dynamic applications for organising and securing cables on machines, control panels or drag chains.

By using aluminium / brass nuts for the screw holes, a better fit of the strain relief plate is achieved, even in high vibration environments.

Advantages & benefits

- Strain relief according to EN 62444
- Easy assembly
- Cost-effective
- High cable density
- Wide variety of mounting options
- Vibration proof

Specifications

Material ZL: Polyamide (PA)
 Bushing:
 Aluminium (ZL-AB)
 Brass (ZL-MS)
 Flame class UL 94 V-0, self-extinguishing
 Temperature -40°C to +140°C (static)
 Properties Halogen-free, silicone-free

Accessories

ZL|SB-EMC Shield plates 229

Type	Order No. for M4 screws	Order No. for M5 screws	Order No. for M6 screws	Length L1	Length L2	No. of teeth	PU
ZL 39 AB ZL 39 MS	32270	32280 32360	32290	38.5 mm	19.5 mm	3	10
ZL 60 AB ZL 60 MS	32271	32281 32361	32291	59.5 mm	43.5 mm	4	10
ZL 70 AB ZL 70 MS	32272	32282 32362	32292	69.1 mm	43.5 mm	5	10
ZL 87 AB ZL 87 MS	32273	32283 32363	32293	86.5 mm	68 mm	6	10
ZL 103 AB ZL 103 MS	32275	32284 32364	32294	102.5 mm	84 mm	7	10
ZL 121 AB ZL 121 MS	32277	32285 32365	32295	121 mm	102.5 mm	8	10
ZL 140 AB ZL 140 MS	32274	32286 32366	32296	139.5 mm	121 mm	9	10
ZL 180 AB ZL 180 MS	32276	32287 32367	32297	180 mm	157 mm	12	10

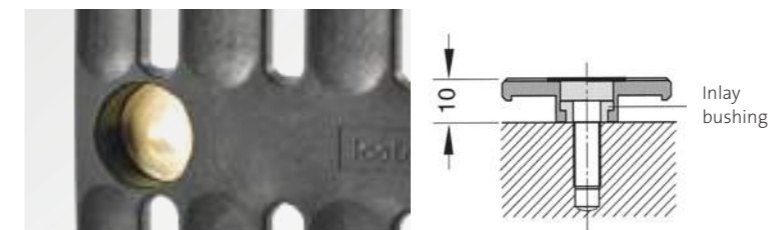
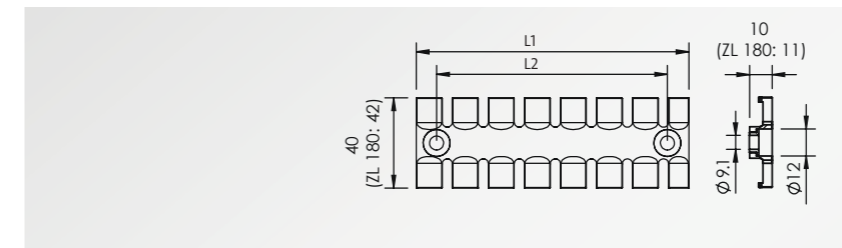

Inlay bushings are also available in brass

ZL 03 | 04 | 05

Strain relief plates
for screw assembly
for various cable diameters

Strain relief plates ZL feature different comb widths. Thus providing a multi-purpose product for various cable sizes. The design of the strain relief unit provides secure strain relief according to EN 62444. Mount of the cables or pneumatic tubing is easily done using cable ties.

Advantages & benefits

- Strain relief according to EN 62444
- Easy assembly
- Cost-effective
- High cable density
- Wide variety of mounting options
- Vibration proof

Specifications

Material	Polyamide (PA)
Flame class	UL 94 V-0, self-extinguishing
Temperature	-40°C to +140°C (static)
Properties	Halogen-free, silicone-free



Type	Order No.	Length L1	Length L2	No. of teeth	PU
ZL 03	32112	63.4 mm	42 mm	4 7	10
ZL 04	32114	95 mm	74.5 mm	6 11	10
ZL 05	32116	119 mm	108 mm	7 13	10

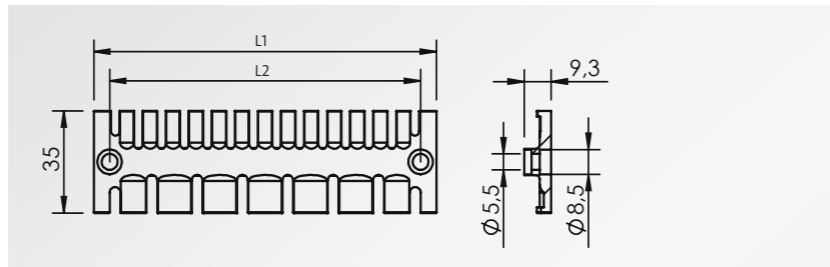

DH Spacers

Due to DH spacers strain relief plates can be mounted in multi-layers to achieve an increase of the cable density.

Advantages & benefits

- Increase of cable density

Specifications

Material Aluminium

Compatible with

ZL Strain relief plates	170
ZL 03 04 05 Strain relief plates	172

Type	Order No.	Fits with	Length	Diameter		PU
				inner	outer	
DH 30	32251	ZL 03 04 05	30 mm	5.2 mm	8.5 mm	10
DH 32	32252	ZL	32 mm	6.2 mm	12 mm	10



KZL

Strain relief plates
for mounting rails



Type	Order No.	Length L1	Length L2	No. of teeth	PU
KZL 11	32250	11.5 mm	-	1	10
KZL 39	32260	38.5 mm	28.3 mm	3	10
KZL 80	32262	79.5 mm	68 mm	6	10
KZL 140	32264	139.5 mm	128.1 mm	9	10

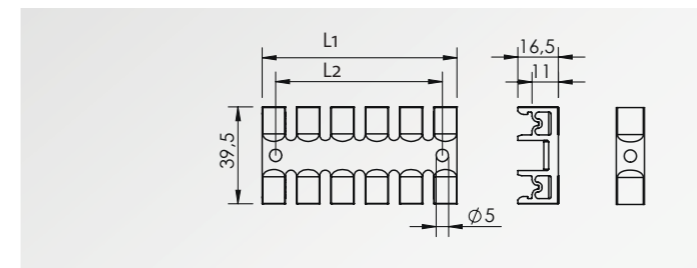

The strain relief plate KZL is used for static or dynamic applications for organising and securing cables on machines, control panels or drag chains.

The design of the strain relief unit provides secure strain relief according to EN 62444. Mount of the cables or pneumatic tubing is easily done using cable ties.

KZL Strain relief plates can be mounted on 30 mm DIN rails (C-rails) and 35 mm top hat DIN rails.

Advantages & benefits

- Strain relief according to EN 62444
- Easy assembly
- Cost-effective
- High cable density
- Wide variety of mounting options
- Vibration proof

Specifications

Material	Polyamide (PA)
Flame class	UL 94 V-0, self-extinguishing
Temperature	-40°C to +140°C (static)
Properties	Halogen-free, silicone-free

SF|ZL

Strain relief plates for 35 mm top hat DIN rail

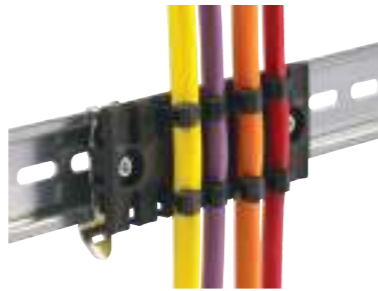

The strain relief plate SF|ZL is used for assembly on 35 mm top hat DIN rails. It can be used for strain relief of cables and conduits.

The SF|ZL range is based upon the strain relief plate ZL, which is mounted on snap feet for 35 mm top hat DIN rails.

Advantages & benefits

- Strain relief according to EN 62444
- Easy assembly
- Cost-effective
- High cable density
- Wide variety of mounting options

Specifications

Material	ZL: Polyamide (PA) SF-foot: Spring steel
Flame class	UL 94 V-0, self-extinguishing
Temperature	-40°C to +140°C (static)
Properties	Halogen-free, silicone-free

Accessories

ZL|SB-EMC Shield plates 229

Type	Order No.	Length L1	Length L2	No. of teeth	PU
SF ZL 39	32351	38.5 mm	19.5 mm	3	10
SF ZL 60	32352	59.5 mm	43.5 mm	4	10
SF ZL 70	32353	69.1 mm	43.5 mm	5	10
SF ZL 87	32354	86.5 mm	68 mm	6	10
SF ZL 103	32355	102.5 mm	84 mm	7	10
SF ZL 121	32356	121 mm	102.5 mm	8	10
SF ZL 140	32357	139.5 mm	121 mm	9	10
SF ZL 180	32358	180 mm	157 mm	12	10

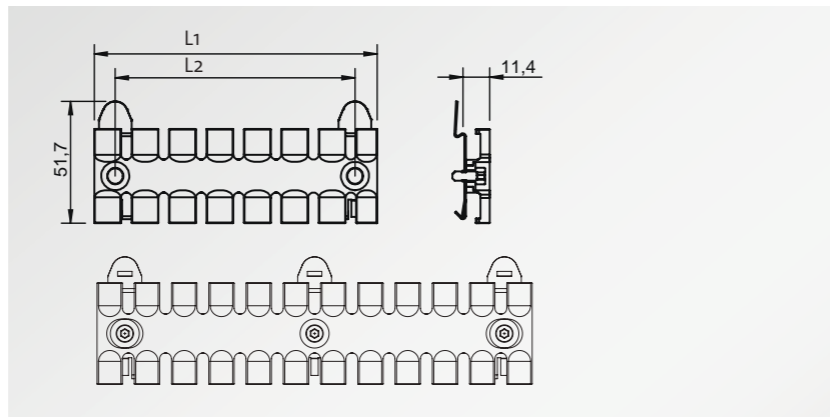

SF|ZL 180

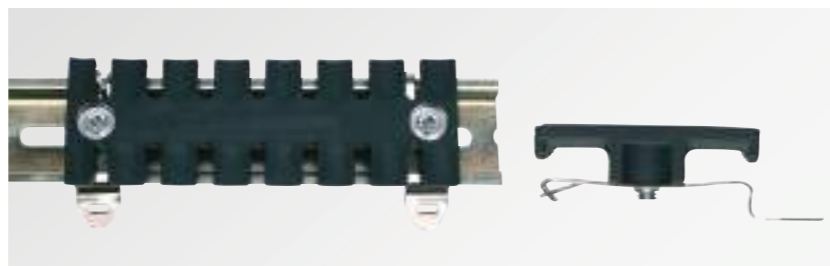

Typical applications



ZL 180
Packaging machines



ZL
Automation



ZL 180
Machine tools

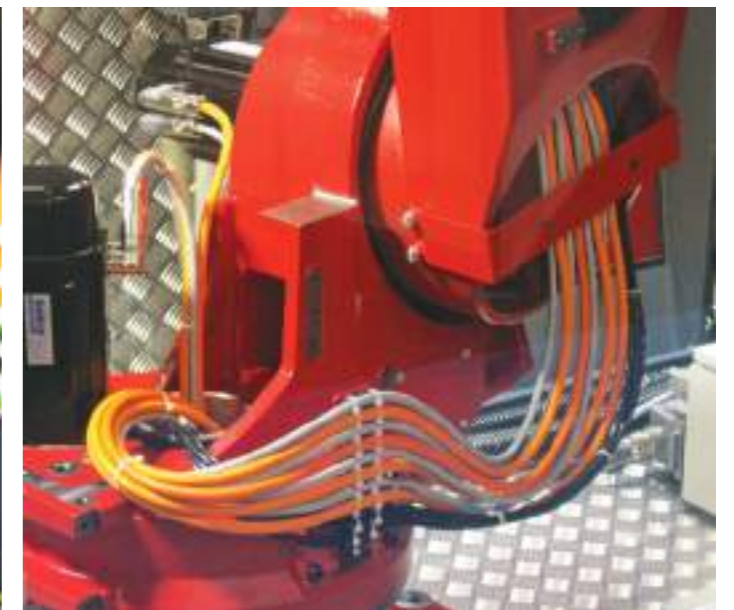

ZL 180
Robotics

3.2 systems for cable management

Organise, bundle, fix:
Hook-and-loop fasteners,
holders for hook-and-loop fasteners

Cable ties with hook-and-loop fasteners are an increasingly common fixing mode for cables. They are used instead of standard cable ties, because they can be easily closed and opened several times. The soft material is gentle on cables, especially where vibrations are present.

Various holders serve as holders for hook-and-loop fasteners, which can be mounted quickly and easily in a variety of ways.



High cable density, multilayer mounting possible



Gentle on cables, especially during vibrations
No sharp edges, no risk of injury



Subsequent removal or addition of cables is easily possible



Available for numerous aluminium profiles and construction profiles

Very quick assembly thanks to 90° rotation lock

Different routing directions of the cables are possible



Available in three sizes: 12, 24 and 36 mm

Very fast assembly, screwable



Holders for hook-and-loop cable ties
various mounting types: screwable, pluggable, available for numerous profiles: Rittal punched section and punched rail, MiniTec profile, Item profile, Bosch Rexroth profile, Maytec profile, Top-hat rail, C-rail, 19" system punchings, suitable for hook-and-loop tape KLB and hook-and-loop fastener KLKB

KBH-S / KBH-R / KBH-SB / KBH-RBA / KBH-RBB

179 – 186



KBH ServiceBox
Service boxes for hook-and-loop tape holders, various mounting types: screwable, pluggable, available for numerous profiles

KBH-S ServiceBox / KBH-R ServiceBox

184 – 185



Hook-and-loop cable ties
for cable management, resealable, re-usable, available in four sizes or as a continuous roll

KLKB / KLB

187

Holders for hook-and-loop cable ties KBH

The holders for hook-and-loop fasteners KBH-S and KBH-R serve as universal holders and as cable routing systems for the hook-and-loop tape KLB and the hook-and-loop fastener KLKB.

With the KBH-R holder, cables can be routed in different directions. The 90° twist lock makes it very easy to mount.

Due to the two-part design of the KBH-R hook-and-loop holder, the cable plate (upper part) can be fixed parallel or at an angle to the profile, depending on the desired cable routing direction. If cables are added or removed later, the cable plate sizes can be changed flexibly.

Advantages & benefits KBH-S

- Available in three sizes: 12, 24 and 36 mm
- Very fast assembly, screwable
- Suitable for hook-and-loop tape KLB and hook-and-loop fastener KLKB

Advantages & benefits KBH-R

- Available in three sizes: 12, 24 and 36 mm
- Very fast assembly due to 90° twist lock
- Suitable for hook-and-loop tape KLB and hook-and-loop fastener KLKB
- Available for numerous aluminium profiles and construction profiles
- Four different guiding directions of the cables possible
- Subsequent removal or addition of cables is easily possible

Specifications KBH-S, KBH-R

Material	Polyamide (PA)
Colour	Black
Flame class	UL 94 V-0, self-extinguishing
Temperature	-40°C to +140°C

Compatible with

KLKB/KLB Cable ties
 with hook-and-loop fastener 187

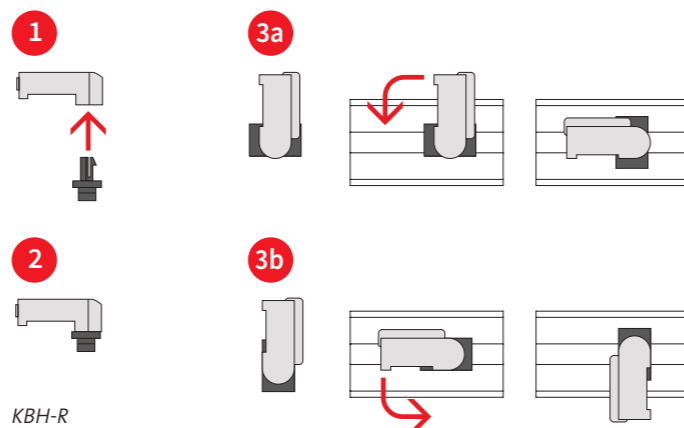

KBH Holders for hook-and-loop cable ties KBH-S, KBH-R

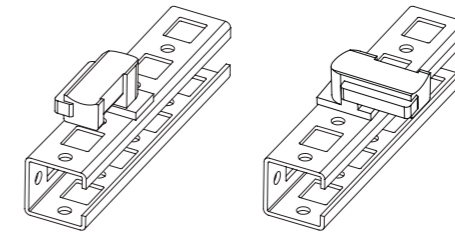

Type	Order No.	fits KLKB KLB	compatible with	PU
Holder for hook-and-loop fastener, assembly with screws				
KBH-S 12 M5	61030	KLKB 200 x 13 KLB 10	universal	10
	61030.9005	KLB 15		50
KBH-S 24 M5	61031	KLKB 200 x 13 KLB 10	universal	10
	61031.9005	KLB 15 KLB 20		50
KBH-S 36-1 M5	61032	KLKB 300 x 17 KLB 15	universal	10
	61032.9005	KLB 20 KLB 25		50
KBH-S 36-2 M5	61033	KLKB 300 x 17 KLB 15	universal	10
	61033.9005	KLB 20 KLB 25		50
Holder for hook-and-loop fastener for Rittal punched section and punched rail				
KBH-R 12 R MS Holder for hook-and-loop fastener, pluggable	61045	KLKB 200 x 13 KLB 10	Rittal punched section and punched rail	10
	61045.9005	KLB 15		50
KBH-R 24 R MS Holder for hook-and-loop fastener, pluggable	61046	KLKB 200 x 13 KLB 10	Rittal punched section and punched rail	10
	61046.9005	KLB 15 KLB 20		50
KBH-R 36-1 R MS Holder for hook-and-loop fastener, pluggable	61047	KLKB 300 x 17 KLB 15	Rittal punched section and punched rail	10
	61047.9005	KLB 20 KLB 25		50

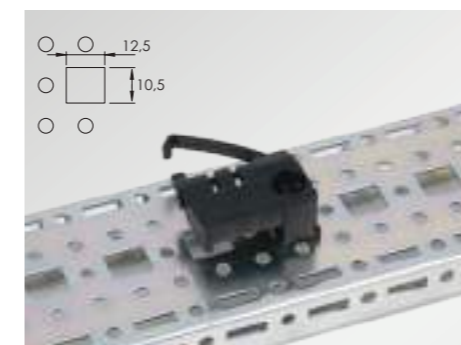

Rittal punched section



KBH
 Holders for
 hook-and-loop cable ties
 KBH-R

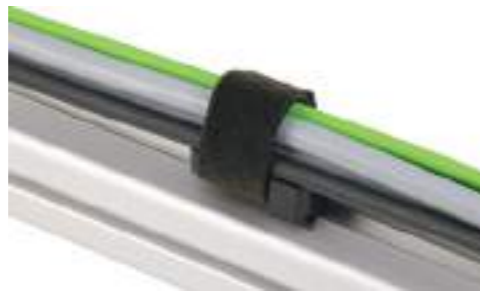

Type	Order No.	fits KLKB KLB	compatible with	PU
Holder for hook-and-loop fastener for MiniTec				
	KBH-R 12 M G8 Holder for hook-and-loop fastener, pluggable	KLKB 200 x 13 KLB 10 KLB 15	MiniTec with 8 mm groove	61048
	61048.9005			
	KBH-R 24 M G8 Holder for hook-and-loop fastener, pluggable	KLKB 200 x 13 KLB 10 KLB 15 KLB 20	MiniTec with 8 mm groove	61049
	61049.9005			
	KBH-R 36-1 M G8 Holder for hook-and-loop fastener, pluggable	KLKB 300 x 17 KLB 15 KLB 20 KLB 25	MiniTec with 8 mm groove	61050
	61050.9005			
Holder for hook-and-loop fastener for Minitec and Item				
	KBH-R 12 M-I G8 Holder for hook-and-loop fastener, pluggable	KLKB 200 x 13 KLB 10 KLB 15	MiniTec, Item with 8 mm groove	61051
	61051.9005			
	KBH-R 24 M-I G8 Holder for hook-and-loop fastener, pluggable	KLKB 200 x 13 KLB 10 KLB 15 KLB 20	MiniTec, Item with 8 mm groove	61052
	61052.9005			
	KBH-R 36-1 M-I G8 Holder for hook-and-loop fastener, pluggable	KLKB 300 x 17 KLB 15 KLB 20 KLB 25	MiniTec, Item with 8 mm groove	61053
	61053.9005			



KBH
 Holders for
 hook-and-loop cable ties
 KBH-R



Type	Order No.	fits KLKB KLB	compatible with	PU
Holder for hook-and-loop fastener for Bosch Rexroth				
	KBH-R 12 B-R G8 Holder for hook-and-loop fastener, pluggable	KLKB 200 x 13 KLB 10 KLB 15	Bosch Rexroth with 8 mm groove	61054
	61054.9005			
	KBH-R 24 B-R G8 Holder for hook-and-loop fastener, pluggable	KLKB 200 x 13 KLB 10 KLB 15 KLB 20	Bosch Rexroth with 8 mm groove	61055
	61055.9005			
	KBH-R 36-1 B-R G8 Holder for hook-and-loop fastener, pluggable	KLKB 300 x 17 KLB 15 KLB 20 KLB 25	Bosch Rexroth with 8 mm groove	61056
	61056.9005			
	KBH-R 12 B-R G10 Holder for hook-and-loop fastener, pluggable	KLKB 200 x 13 KLB 10 KLB 15	Bosch Rexroth with 10 mm groove	61057
	61057.9005			
	KBH-R 24 B-R G10 Holder for hook-and-loop fastener, pluggable	KLKB 200 x 13 KLB 10 KLB 15 KLB 20	Bosch Rexroth with 10 mm groove	61058
	61058.9005			
	KBH-R 36-1 B-R G10 Holder for hook-and-loop fastener, pluggable	KLKB 300 x 17 KLB 15 KLB 20 KLB 25	Bosch Rexroth with 10 mm groove	61059
	61059.9005			

KBH
 Holders for
 hook-and-loop cable ties
 KBH-R



Type	Order No.	fits KLKB KLB	compatible with	PU	
Holder for hook-and-loop fastener for item (6 mm groove)					
	KBH-R 12 I G6 Holder for hook-and-loop fastener, pluggable	61061	KLKB 200 x 13 KLB 10 KLB 15	item with 6 mm groove	10 50
	61061.9005				
	KBH-R 24 I G6 Holder for hook-and-loop fastener, pluggable	61062	KLKB 200 x 13 KLB 10 KLB 15 KLB 20	item with 6 mm groove	10 50
	61062.9005				
Holder for hook-and-loop fastener for Maytec					
	KBH-R 12 May-G8 Holder for hook-and-loop fastener, pluggable	61065	KLKB 200 x 13 KLB 10 KLB 15	Maytec PG40 with 8 mm groove	10 50
	61065.9005				
	KBH-R 24 May-G8 Holder for hook-and-loop fastener, pluggable	61066	KLKB 200 x 13 KLB 10 KLB 15 KLB 20	Maytec PG40 with 8 mm groove	10 50
	61066.9005				
KBH-R 36-1 I G6 Holder for hook-and-loop fastener, pluggable		61063	KLKB 300 x 17 KLB 15 KLB 20 KLB 25	item with 6 mm groove	10 50
		61063.9005			
KBH-R 36-1 May-G8 Holder for hook-and-loop fastener, pluggable		61067	KLKB 300 x 17 KLB 15 KLB 20 KLB 25	Maytec PG40 with 8 mm groove	10 50
		61067.9005			

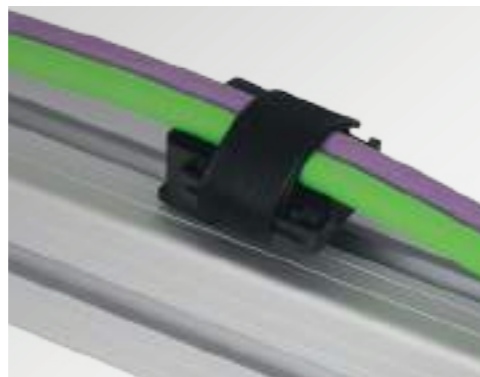

KBH
 Holders for
 hook-and-loop cable ties
 KBH-R



Type	Order No.	fits KLKB KLB	compatible with	PU	
Holder for hook-and-loop fastener for assembly on 35 mm top hat DIN rails					
	KBH-R 12-SF-M4 Holder for hook-and-loop fastener, pluggable	61068	KLKB 200 x 13 KLB 10 KLB 15	35 mm top hat DIN rails	10 50
	61068.9005				
	KBH-R 24-SF-M4 Holder for hook-and-loop fastener, pluggable	61069	KLKB 200 x 13 KLB 10 KLB 15 KLB 20	35 mm top hat DIN rails	10 50
	61069.9005				
Holder for hook-and-loop fastener for assembly on C-rails					
	KBH-R 12-SC Holder for hook-and-loop fastener, assembly with screws	61070	KLKB 200 x 13 KLB 10 KLB 15	C-rails with an opening dimension of 16–17 mm	10 50
	61070.9005				
	KBH-R 24-SC Holder for hook-and-loop fastener, assembly with screws	61071	KLKB 200 x 13 KLB 10 KLB 15 KLB 20	C-rails with an opening dimension of 16–17 mm	10 50
	61071.9005				
Holder for hook-and-loop fastener for assembly on 19" system punching					
	KBH-R 12 9,5 Holder for hook-and-loop fastener, pluggable	61073	KLKB 200 x 13 KLB 10 KLB 15	19" system punching 9,5 x 9,5 mm	10 50
	61073.9005				
	KBH-R 24 9,5 Holder for hook-and-loop fastener, pluggable	61074	KLKB 200 x 13 KLB 10 KLB 15 KLB 20	19" system punching 9,5 x 9,5 mm	10 50
	61074.9005				



3.2

3.2

KBH ServiceBox

Service case with assortment of holders for hook-and-loop fasteners

Convenient – everything available right away!

The KBH service cases are ideal for installation or maintenance work, but the range also provides useful services for new developments.

With the KBH-S and KBH-R service cases, the required holders are always available.

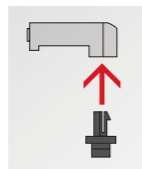

The pluggable holders for hook-and-loop fasteners are created by combining KBH-S screw-on cable plates and bases matched to the respective profile.



KBH-S ServiceBox for assembly with screws

Content *
 50× KBH-S 12 M5
 25× KBH-S 24 M5
 25× KBH-S 36-2 M5
 1× KEL-DPZ 25 cable entry plate
 1× icotek screwdriver

Order No. 88031



KBH-R ServiceBox for Rittal punched section and punched rail

Content *
 50× KBH-S 12 M5
 30× KBH-S 24 M5
 20× KBH-S 36-1 M5
 100× RS M5 base for Rittal punched section and punched rail
 1× KEL-DP 32 cable entry plate
 1× QVT 20 cable gland
 1× icotek screwdriver

Order No. 88032



KBH-R ServiceBox for MiniTec and item profiles with 8 mm groove

Content *
 40× KBH-S 12 M5
 20× KBH-S 24 M5
 30× KBH-S 36-1 M5
 90× RS M-I G8 base for MiniTec and item profiles with 8 mm groove
 1× KEL-DP 20 cable entry plate
 1× icotek screwdriver

Order No. 88033

* Subject to alterations



KBH-R ServiceBox for BoschRexroth profiles with 8 mm groove

Content *
 30× KBH-S 12 M5
 30× KBH-S 24 M5
 20× KBH-S 36-1 M5
 80× RS B-R G8 base for BoschRexroth profiles with 8 mm groove
 1× KEL-SCDP-TR 32 cable entry plate
 1× icotek screwdriver

Order No. 88034



KBH-R ServiceBox for item profiles with 6 mm groove

Content *
 40× KBH-S 12 M5
 20× KBH-S 24 M5
 30× KBH-S 36-1 M5
 90× RS item G6 base for item profiles with 6 mm groove
 1× KEL-DPZ 25|4 grey cable entry plate
 1× icotek screwdriver

Order No. 88035



KBH-R ServiceBox for MayTec profiles with 8 mm groove

Content *
 40× KBH-S 12 M5
 20× KBH-S 24 M5
 30× KBH-S 36-1 M5
 90× MT G8.3 base for MayTec PG40 profiles with 8 mm groove
 1× KEL-DPZ 25|4 grey cable entry plate
 1× icotek screwdriver

Order No. 88036



KBH-R ServiceBox for 19" system punching

Content *
 50× KBH-S 12 M5
 30× KBH-S 24 M5
 100× RS R G9.5 base for 19" system punching 9,5 × 9,5 mm
 1× KEL-DP 32|7 grey cable entry plate
 1× QVT 20 cable gland, QT 4
 1× icotek screwdriver

Order No. 88037

* Subject to alterations

KBH Holders for hook-and-loop cable ties



These holders can be used in combination with cable ties with hook-and-loop fastener KLKB and hook-and-loop tape KLB.

Large variety of holders provides unique and numerous mounting possibilities.

The KBH-R hook-and-loop tape holder is particularly suitable for tool-free mounting in the VX25 enclosure from Rittal.

Advantages & benefits

- Assembly within seconds
- Secure hold
- Flexible usage

Specifications KBH-S / KBH-R

Material Polyamide (PA)
 Colour ■ black
 Flame class UL 94 V-0, self-extinguishing
 Temperature -40°C to +110°C
 Properties Halogen-free, silicone-free

Specifications KBH-SB / KBH-RBA





Material Polyamide (PA)
 Colour ■ black (KBH-SB) □ nc (KBH-RBA)
 Flame class UL 94 V-2
 Temperature -40°C to +85°C (short-term to 110°C)

Specifications KBH-RBB

Material Polyamide (PA)
 Colour ■ black
 Temperature -40°C to +120°C

Compatible with

KLKB/KLB Cable ties with hook-and-loop fastener 187

Description	Type	Order No.	fits KLKB KLB	compatible with	PU
Holder for hook-and-loop fastener, screwable					
	KBH-S	■ 61019	KLKB 200×7 KLKB 200×13 KLB10	23 × 23 mm mounting rail	100
	KBH-SB	■ 61002	KLKB 200×7	universal	100
Holder for hook-and-loop fastener, pluggable					
	KBH-R	■ 61018	KLKB 200×7 KLKB 200×13 KLB10	23 × 23 mm mounting rail systems for Rittal VX25	100
	KBH-RBA nc	□ 61003	KLKB 200×7	drill-hole Ø 6 mm	100
	KBH-RBB	■ 61004	KLKB 200×7	drill-hole Ø 6.5 mm	100

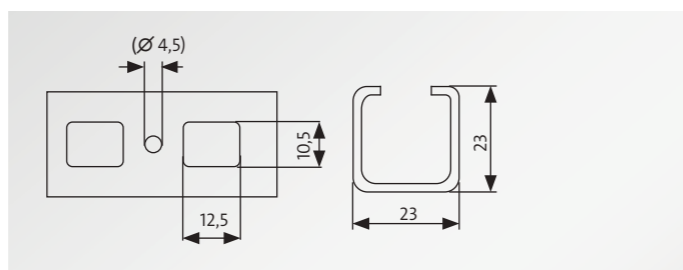

23 × 23 mm mounting rail

* Only KBH-S / KBH-R

KLKB | KLB Hook-and-loop cable ties



Type	Size [mm]			Order No.	PU
	L	W1	W2		
KLKB 200 × 7 bk (PU 100 = 1 reel)	200	13	7	61021	100
KLKB 200 × 7 bk on reel (750 pcs.)	200	13	7	61025	1
KLKB 200 × 13 bk (PU 100 = 1 reel)	200	20	13	61022	100
KLKB 200 × 13 bk on reel (750 pcs.)	200	20	13	61026	1
KLKB 230 × 13 bk (PU 100 = 1 reel)	230	20	13	61023	100
KLKB 230 × 13 bk on reel (650 pcs.)	230	20	13	61027	1
KLKB 300 × 17 bk (PU 100 = 1 reel)	300	25	17	61024	100
KLKB 300 × 17 bk on reel (500 pcs.)	300	25	17	61028	1
KLB 10 bk			10	61011	25 m
KLB 15 bk			15	61012	25 m
KLB 20 bk			20	61013	25 m
KLB 25 bk			25	61014	25 m

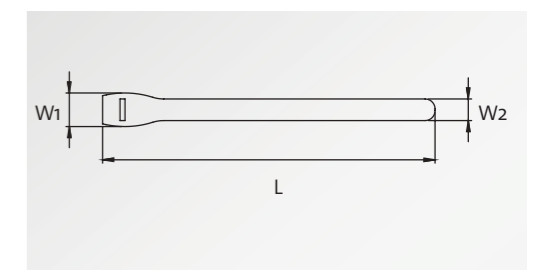
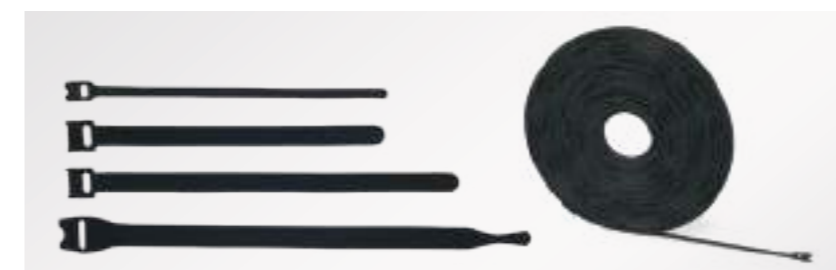

Cable ties with hook-and-loop fasteners are a more and more common fixing mode for cables. They are used instead of standard cable ties, because they can be easily closed and opened several times. The soft material is gentle on cables, especially where vibrations are present.

Hook-and-loop cable ties are available individually (KLKB) in four different sizes or as a continuous roll (KLB) in four different sizes.

Advantages & benefits

- Reusable
- Adaptable
- The cable tie material is gentle on cables, especially if there are vibrations

Specifications

Material Polypropylene + Velours PA
 Colour black
 Temperature -30°C to +80°C

Accessories

KBH Holder for hook-and-loop fastener 179 - 186

4 EMC solutions

Shield clamps & cable entry systems



The icotek EMC shield clamps are characterised by excellent dissipation of high-frequency interference and efficient EMC shielding for cables from 1.5 to 75 mm diameter.

In case of conducted as well as field bound EMI disturbances, our split cable entry system EMC-KEL-DS and our split cable gland EMC-KVT-DS offer an effective way to divert and block those disturbances and provides an alternative to conventional EMC cable glands.

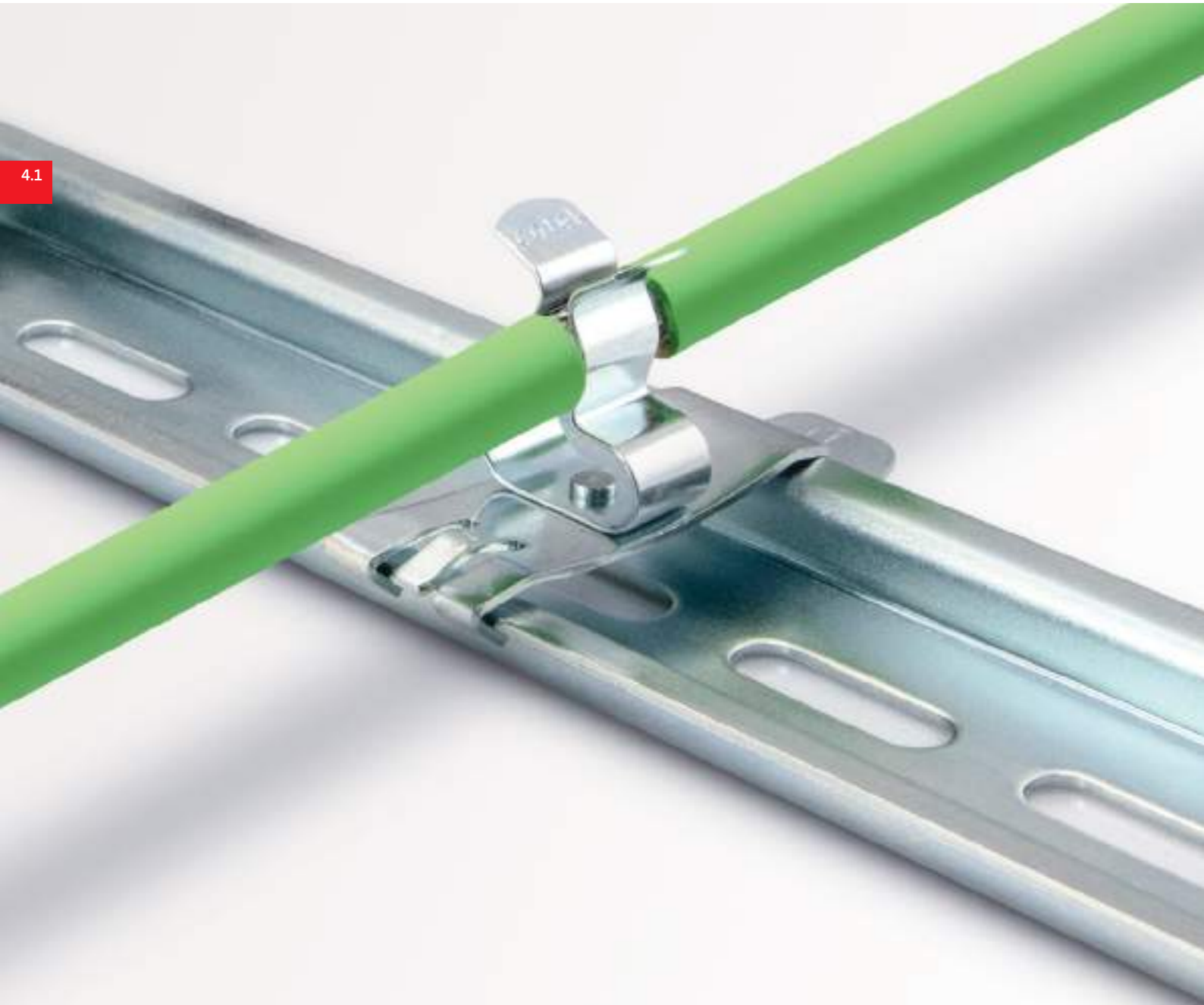

Product range shield clamps	Mounting type	Strain relief	Multi shield clamps	Page
MSKL / SKL	for screw mounting	■		195 – 197
LF	for screw mounting	■		198 – 199
SF	for 35 mm top hat DIN rails	■		200 – 201
PFS	for bus bars	■	■	202 – 205
SC	for C-rails	■		206 – 209
PFK	pluggable	■	■	210 – 213
PCB	for printed circuit boards			214
STFZ	for decentralised bus modules	■	■	215 – 217
RLF	Row solutions	■	■	220 – 223

Product range EMC cable entry frames	IP55	Strain relief	Cable Ø mm min max	For max. no. of cables	Page
EMC-KEL-DS	■	■	1 – 35	10	236 – 237
EMC-KVT-DS	■	■	1 – 35	4	238 – 239
EMC-KEL-U			1 – 35	10	240 – 241

4.1 EMC cable shield earthing

Shield clamps and earthing components



For process measurement and control equipment, an increasingly higher level of protection against failure is required. Earthing of the cable shields is very important. The area where the cable shield is connected to the enclosure earth is a critical point. It is very important that the connection has a low resistance.

icotek EMC products therefore provide a good solution. The SKL shield clamps offer a large contact area to the cable shield (see figure A). In comparison to conventional shield brackets (see figure B) an up to 50% higher

contact area can be achieved when using the SKL line. The specified clamping range can be exceeded up to 10%.

In high frequency fields, the SKL shield clamps provide a low resistance. The effective range is up to 1,000 MHz below 120 Ohms and 10 kHz to 100 MHz significant below 20 Ohms.

Assembly possibilities



Assembly with rivets



Assembly with screws



Assembly on 35 mm top hat DIN rails



Assembly on 10 x 3 mm bus bars



Assembly on 30 mm C-rails



Assembly by clamping onto sheet edges

Advantages of solid rivets



- Vibration resistance according to EN 61373
- Twist protection due to solid rivets
- Stronger contact pressure of the riveted parts

SKL | MSKL | SKZ clamping ranges

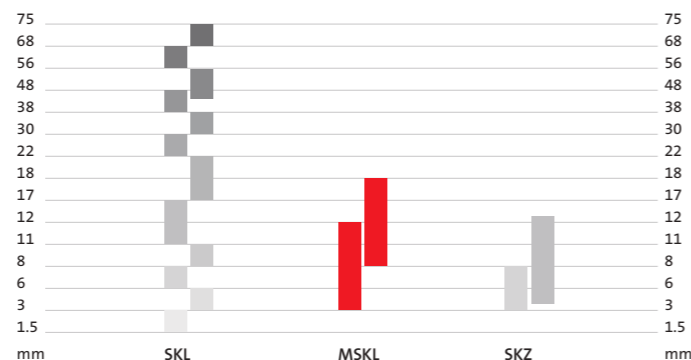

* Shield connections are not certifiable as components according to the requirements of the directive and the standards for electrical equipment in potentially explosive atmospheres. Thus, the use of the shield connections in hazardous areas is possible even without a corresponding approval and marking.

MSKL type with large clamping range

Large contact area to the cable shield. Shield and cable strands will not be squeezed

Available in various sizes

High cable density possible

Vibration resistance and twist protection due to solid rivets

Wide variety in mounting types: top hat DIN rail/C-rail snap mount, screw mount

Secure hold for cable ties and cables, strain relief acc. to EN 62444

Do not use the shield connection as a strain relief location!

Figure A: SKL-line **Figure B: Conventional systems**

EMC shield clamps MSKL

Due to its special design, the clamping ranges of the MSKL are very large while the dimensions are comparatively small. (Example: MSKL 3-12, assembled with a 12 mm cable shield: width 26.25 mm).

Advantages & benefits

- Large clamping areas, therefore less product sizes needed to cover a large cable diameter range
- Space-saving design, even when fully assembled
- Partially with integrated strain relief
- Large cable shield contact area
- Easy assembly
- The spring design requires no adjustments and will permanently maintain contact to the cable shield
- Shock and vibration resistant, maintenance free



More information about the connection between the cable shield and the equipotential bonding bar in PROFINET applications: www.icotek.com/en/profinet

Chapter content



EMC shield clamps for assembly with rivets/screws with/without strain relief function

MSKL, SKL, RCL|MSKL, RCL|SKL, RCLZ|MSKL, MB+MSKL/SKL

195 – 197



EMC shield clamps for assembly with screws with/without strain relief function

LFZ-M|MSKL, LFZ|SKL, LFZ-U|SKL, LFZ-U-AB, LFZ-M(45°)|MSKL, LFZ-M(90°)|MSKL, LF2Z-M|SKL, SKZ, LF|MSKL, LF|SKL, SK

198 – 199

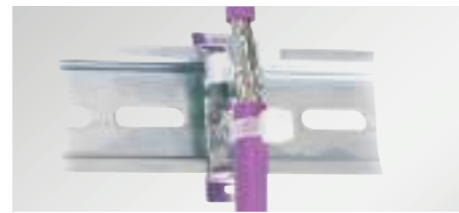

EMC shield clamps for 35 mm top hat DIN rails with/without strain relief function

SFZ-M|MSKL, SFZ|SKL, SF2Z-M|MSKL, SF2Z|SKL, SF|SKZ, SF-M|MSKL, SF|SKL, SFS|SKL, SF|SK

200 – 201



EMC Shield clamp assemblies

RLFZ(-M) - clamp assembly for screw mount
SC|RLFZ(-M) - clamp assembly for C-rails
SF|RLFZ - clamp assembly for top hat rails
RLF - clamp assembly without strain relief

220 – 223



EMC cable assemblies as accessories for cable entry components with/without strain relief function

KEL-EMC-Z / KEL-EMC-PF / KEL-EMC / KVT-EMC

224 – 227



EMC strain relief plates various mounting types

KAFM

228 – 229



EMC shield clamps for 10 x 3 mm bus bars with/without strain relief function, single and double

PFSZ-M|MSKL, PFSZ|SKL, PFS2Z-M|MSKL, PFS2Z|SKL, SS|SKZ, PFS|SKL, PFS|SCL, SS|SK, SKS, PFS2Z|SKL, PFS2|SKL

202 – 205



EMC shield clamps for 30 mm C-rails with/without strain relief function

SC|LFZ-M|MSKL, SC|LFZ|SKL, SC|LF2Z-M|MSKL, SC|SKZ, SC|LF|MSKL, SC|LF|SKL, SC|SK, LFC, CC-LFC

206 – 209



EMC shield clamps for assembly on sheet edges with/without strain relief function, single and double

PFKZ-M|MSKL, PFKZ|SKL, PFK|SKL, PFKZ2|SKL, PFK2|SKL

210 – 213



Earthing tapes for assembly with screws

MB

230 – 232



EMC Split cable entry frames for cable diameters up to 35 mm

EMC-KEL-DS

236 – 237



EMC Split cable gland for screw-on assembly with a locknut M32, M63 for cable diameters up to 35 mm

EMC-KVT-DS

238 – 239



Shield clamps for printed circuit boards

PCB|SKL

214



Shield clamps for decentralised bus modules

STFZ|SKL / STFZ2|SKL / STFZ-U|SKL / STFZ-SP|SKL / STFZ2-SP|SKL

215 – 217



Assortment of SKL shield clamps

EMC ServiceBox multi
EMC ServiceBox

218 – 219



EMC Configurator
www.icotek.com/emc

4.1

4.1

IP55

IP55



Leakage and Impedance

All icotek shield clamps have been tested utilising various frequency ranges and in all tests there was minimal leakage resistance.

icotek EMC shield clamps are proven to absorb electromagnetic interferences.

Electrical impedance values:
- from 10 kHz to 100 MHz under 20 Ohm
- up to 1.000 MHz under 120 Ohm

The unique design of icotek shield clamps effectively reduce high frequency interferences.

Contact area

The SKL shield clamps offer a large contact area to the cable shield (see figure A).

In comparison to conventional shield clamps, an up to 50% higher contact area is achieved when using the SKL product line.

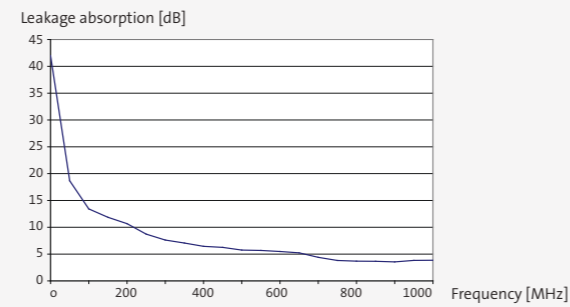
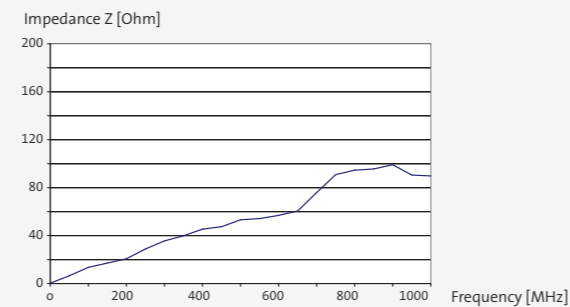

Figure A: SKL-line

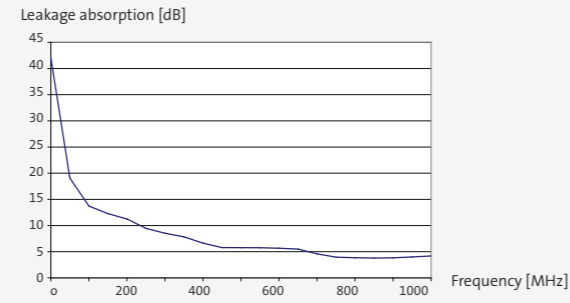
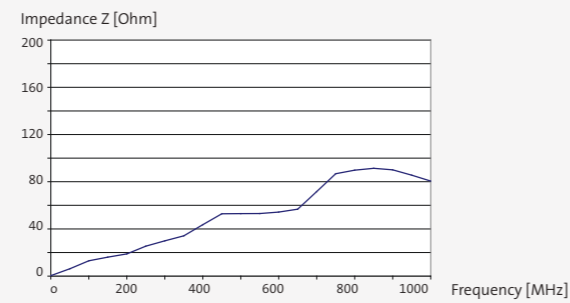

Figure B: Conventional systems

LF|SKL 8-11



SF|SKL 6-8



EMC shield clamps for assembly with rivets



	MSKL single	SKL single	
Clamping range	Order No.	Order No.	
MSKL	3 – 12 mm	37600	–
	8 – 18 mm	37602	–
SKL	1.5 – 3 mm	–	36200
	3 – 6 mm	–	36202
	6 – 8 mm	–	36204
	8 – 11 mm	–	36205
	11 – 17 mm	–	36206
	17 – 22 mm	–	36207
	22 – 30 mm	–	36208
	30 – 38 mm **	–	36209 *
	38 – 48 mm **	–	36213 *
	44 – 56 mm	–	36216 *
56 – 68 mm	–	36217 *	
68 – 75 mm	–	36218 *	
PU	50	50 * 5	

SF single | SFS single | SC single

Type	Order No.	PU	
SF single M4	36230	Mounting foot, single with screw thread M4	10
SF single M5	36221	Mounting foot, single with screw thread M5	10
SFS single	36229	Mounting foot, single	10
SC single	36231	Screw-foot single, for 30 mm DIN-rail shape C (width of mouth: 16 mm) with twist protection notch	10



MSKL

Whenever a cable shielding is required with the possibility of grounding, EMC shield clamps can be used. Shield clamps are easy to use and effective in dissipating conducted disturbances.

Due to its special design, the clamping ranges of the MSKL are very large while the dimensions are comparatively small. (Example: MSKL 3-12, assembled with a 12 mm cable shield: width 26.25 mm).

Assembly

The shield clamps can be mounted using rivets.

Advantages & benefits

- Large clamping areas, therefore less product sizes needed to cover a large cable diameter range
- Space-saving design, even when fully assembled
- Partially with integrated strain relief
- Large cable shield contact area
- Easy assembly
- The spring design requires no adjustments and will permanently maintain contact to the cable shield
- Shock and vibration resistant, maintenance free

Specifications

Material
MSKL clamp, SK clamp Spring steel, galvanised
** SKL 30–38 mm, SKL 38–48 mm Stainless steel



SF single

SFS single

SC single

EMC shield clamps on cable lugs for assembly with rivets



Whenever a cable shielding is required with the possibility of grounding, EMC shield clamps can be used. Shield clamps are easy to use and effective in dissipating conducted disturbances.

Assembly

The shield clamps can be mounted using rivets.

Advantages & benefits

- Large contact area
- Simple and tool-free mounting, easy assembly
- The spring design requires no adjustments and will permanently maintain contact to the cable shield
- Shock and vibration resistant, maintenance free
- Designed for high density applications

Specifications

Material
MSKL clamp, SK clamp Spring steel, galvanised
Cable lug UL listed

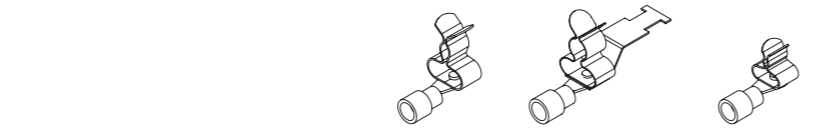

	RCL MSKL	RCLZ MSKL with cable fixation	RCL SKL		
Clamping range	RCL	Order No.	Order No.		
MSKL	3 – 12 mm	0.5 – 1.5 mm ²	36296.2	36301.2	–
	3 – 12 mm	1.0 – 2.5 mm ²	36297.2	36302.2	–
	3 – 12 mm	4 – 6 mm ²	36298.2	36303.2	–
SKL	1.5 – 3 mm	0.5 – 1.5 mm ²	–	–	36296.1
	1.5 – 3 mm	1.0 – 2.5 mm ²	–	–	36297.1
	1.5 – 3 mm	4 – 6 mm ²	–	–	36298.1
	3 – 6 mm	1.0 – 2.5 mm ²	–	–	36297.3
	6 – 8 mm	1.0 – 2.5 mm ²	–	–	36297.4
	8 – 11 mm	1.0 – 2.5 mm ²	–	–	36297.5
PU			25	25	25



Applications in which both cable shields must be brought to the same potential



Example for an application with RCL|MSKL 3-12

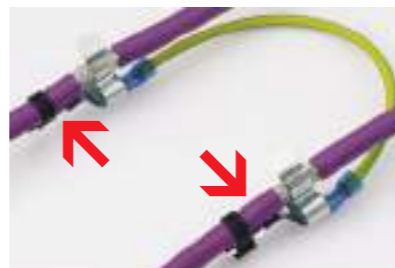

Example for an application with RCLZ|MSKL 3-12. The contacted electrical cables are also fixed.

MB|MSKL Earthing tapes with fitted shield clamps with/without cable fixation



Type	Order No.	Length L [mm]	Cross-section mm ²	Hole size	Clamping range [mm]	PU
Cross-section 6 mm²						
MB 100 6 M4+M4 MSKL 3-12	32695.01	100	6	M4	3 – 12	10
MB 100 6 M4+M4 MSKL 8-18	32695.02	100	6	M4	8 – 18	10
MB 100 6 M4+M4 Z-MSKL 3-12*	32695.011	100	6	M4	3 – 12	10
MB 100 6 M4+M4 Z-MSKL 8-18*	32695.021	100	6	M4	8 – 18	10
MB 150 6 M4+M4 MSKL 3-12	39710.01	150	6	M4	3 – 12	10
MB 150 6 M4+M4 MSKL 8-18	39710.02	150	6	M4	8 – 18	10
MB 150 6 M4+M4 Z-MSKL 3-12*	39710.011	150	6	M4	3 – 12	10
MB 150 6 M4+M4 Z-MSKL 8-18*	39710.021	150	6	M4	8 – 18	10
MB 200 6 M4+M4 MSKL 3-12	32707.01	200	6	M4	3 – 12	10
MB 200 6 M4+M4 MSKL 8-18	32707.02	200	6	M4	8 – 18	10
MB 200 6 M4+M4 Z-MSKL 3-12*	32707.011	200	6	M4	3 – 12	10
MB 200 6 M4+M4 Z-MSKL 8-18*	32707.021	200	6	M4	8 – 18	10
Cross-section 10 mm²						
MB 100 10 M6+M4 MSKL 3-12	39711.01	100	10	M6	3 – 12	10
MB 100 10 M6+M4 MSKL 8-18	39711.02	100	10	M6	8 – 18	10
MB 100 10 M6+M4 Z-MSKL 3-12*	39711.011	100	10	M6	3 – 12	10
MB 100 10 M6+M4 Z-MSKL 8-18*	39711.021	100	10	M6	8 – 18	10

The earthing tapes are fitted with a shield clamp at one end. This solution is used where space is limited.

The earthing tapes are available with M4 or M6 holes.

Advantages & benefits

- Very flexible assembly
- Installation even in places that are difficult to access
- Earthing tapes with pressed-on connecting end pads
- Standard products, short delivery times
- UL listed earthing tapes

Specifications

Material Earthing tape: Copper tin-plated
with pressed-on connecting end pads
Shield clamp MSKL: Spring steel galvanised

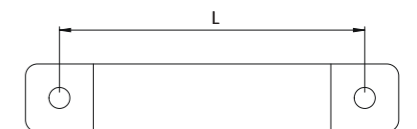

Earthing tape with shield clamp MSKL



Earthing tape with shield clamp MSKL and cable fixation

* with cable fixation

EMC shield clamps for assembly with screws with strain relief function



LFZ-U|SKL

Whenever a cable shielding is required with the possibility of grounding, EMC shield clamps can be used. Shield clamps are easy to use and effective in dissipating conducted disturbances.

Optional strain relief function: the cable is fixed via the cable jacket using cable ties.

Shield clamps are easily attached to mounting plates via screw. The shield clamp LFZ-U|SKL is available for M4 or M5 screws. During assembly it is sufficient to loosen the existing screw slightly to be able to slide the clamp underneath before re-tightening the screw.

Assembly

The shield clamps can be mounted using screws, e.g. on a mounting plate.

Advantages & benefits

- Integrated strain relief function
- Large cable shield contact area
- Easy, tool-free assembly
- The spring design requires no adjustments and will permanently maintain contact to the cable shield
- Designed for high density applications
- Shock and vibration resistant, maintenance free
- Double strain relief: acc. to PROFINET installation guidelines

Specifications

Material	
MSKL clamp, SKL clamp	Spring steel, zinc plated
LF/LFZ foot	Steel, galvanically zinc plated fixing hole 4.2 mm/5.2 mm
SK bracket	Steel, galvanically zinc plated

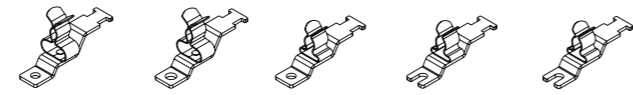

	LFZ-M MSKL Fixing hole M4	LFZ-M MSKL Fixing hole M6	LFZ SKL Fixing hole M4	LFZ-U SKL Fixing hole M4	LFZ-U SKL Fixing hole M5	
	Order No.	Order No.	Order No.	Order No.	Order No.	
MSKL	Clamping range					
	3 – 12 mm	37612	37373	–	–	
	8 – 18 mm	37614	37388	–	–	
SKL	1.5 – 3 mm	–	–	36910	36886.1	
	3 – 6 mm	–	–	36915	36886.2	
	6 – 8 mm	–	–	36920	36886.3	
	8 – 11 mm	–	–	36925	36886.4	
	11 – 17 mm	–	–	36930	36886.5	
	17 – 22 mm	–	–	36935	–	
	22 – 30 mm	–	–	36940	–	
	30 – 38 mm	–	–	36941	–	
	PU	10	10	10	10	10

EMC shield clamps for assembly with screws with/without strain relief function

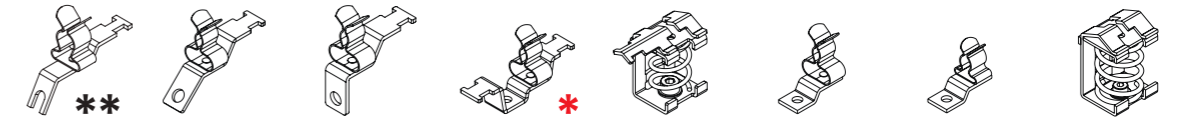

	LFZ-U-AB Fixing hole M4	LFZ-M(45°) MSKL Fixing hole M5	LFZ-M(90°) MSKL Fixing hole M5	LF2Z-M MSKL* Fixing hole M4	SKZ Fixing hole M4	LF MSKL Fixing hole M4	LF SKL Fixing hole M4	SK Fixing hole M4	
	Order No.	Order No.	Order No.	Order No.	Order No.	Order No.	Order No.	Order No.	
MSKL	Clamping range								
	3 – 12 mm	–	37660.1	37661.1	37665.150	–	37608	–	
	8 – 18 mm	–	37660.2	37661.2	37666.150	–	37610	–	
SKL	1.5 – 3 mm	–	–	–	–	–	–	36251	
	3 – 6 mm	–	–	–	–	–	–	36253	
	6 – 8 mm	36948.3	–	–	–	–	–	36255	
	8 – 11 mm	36948.4	–	–	–	–	–	36256	
	11 – 17 mm	–	–	–	–	–	–	36257	
	17 – 22 mm	–	–	–	37590.150	–	–	36258	
	22 – 30 mm	–	–	–	37591.150	–	–	36259	
	3 – 8 mm	–	–	–	–	36222	–	–	36222.002
SK/SKZ	4 – 13.5 mm	–	–	–	36224	–	–	–	36224.002
	10 – 20 mm	–	–	–	–	–	–	–	36226
	15 – 32 mm	–	–	–	–	–	–	–	36228
	PU	10	10	10	10	10	10	10	10

* with double strain relief function

** LFZ-U-AB are especially suitable for mounting on Allen Bradley Powerflex 525/527 frequency inverters. Direct contacting on the converter saves space and interference signals are picked up directly at the interference source.



EMC shield clamps for 35 mm top hat DIN rails with strain relief function



SFZ-M|MSKL

Whenever a cable shielding is required with the possibility of grounding, EMC shield clamps can be used. Shield clamps are easy to use and effective in dissipating conducted disturbances.

Optional strain relief function: the cable is fixed via the cable jacket using cable ties.

Assembly

The shield clamps can be mounted on 35 mm top hat DIN rails.

Advantages & benefits

- Integrated strain relief function
- Large cable shield contact area
- Easy, tool-free assembly
- The spring design requires no adjustments and will permanently maintain contact to the cable shield
- Designed for high density applications
- Shock and vibration resistant, maintenance free
- Double strain relief: acc. to PROFINET installation guidelines

Specifications

Material
 MSKL clamp, SKL clamp Spring steel, zinc plated
 SF/SFZ foot Spring steel
 SK bracket Steel, galvanically zinc plated

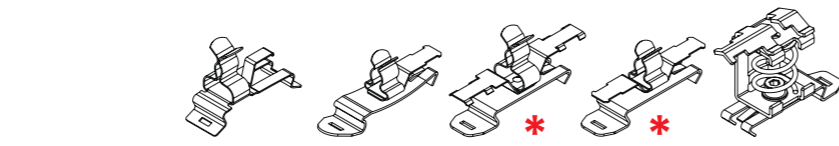

	SFZ-M MSKL	SFZ SKL	SF2Z-M MSKL	SF2Z SKL	SF SKZ
Clamping range	Order No.	Order No.	Order No.	Order No.	Order No.
MSKL	3 – 12 mm	37620	–	37620.150	–
	8 – 18 mm	37622	–	37622.150	–
SKL	1.5 – 3 mm	–	36850	–	36850.150
	3 – 6 mm	–	36855	–	36855.150
	6 – 8 mm	–	36860	–	36860.150
	8 – 11 mm	–	36865	–	36865.150
	11 – 17 mm	–	36870	–	36870.150
	17 – 22 mm	–	36875	–	36875.150
	22 – 30 mm	–	36880	–	36880.150
SKZ	3 – 8 mm	–	–	–	36500
	4 – 13.5 mm	–	–	–	36502
PU	10	10	10	10	10

* with double strain relief function

EMC shield clamps for 35 mm top hat DIN rails without strain relief



SFS|SKL

Whenever a cable shielding is required with the possibility of grounding, EMC shield clamps can be used. Shield clamps are easy to use and effective in dissipating conducted disturbances.

Assembly

The shield clamps can be mounted on 35 mm top hat DIN rails.

Advantages & benefits

- Large cable shield contact area
- Easy, tool-free assembly
- The spring design requires no adjustments and will permanently maintain contact to the cable shield
- Designed for high density applications
- Shock and vibration resistant, maintenance free

Specifications

Material
 MSKL clamp, SKL clamp Spring steel, zinc plated
 SF/SFZ foot Spring steel
 SK bracket Steel, galvanically zinc plated

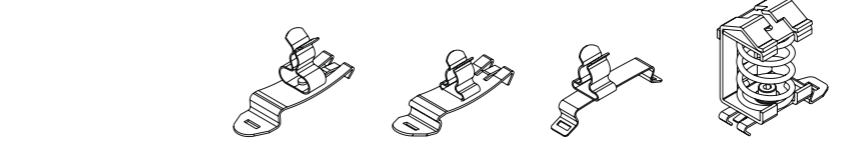

	SF-M MSKL	SF SKL	SFS SKL	SF SK
Clamping range	Order No.	Order No.	Order No.	Order No.
MSKL	3 – 12 mm	37616	–	–
	8 – 18 mm	37618	–	–
SKL	1.5 – 3 mm	–	36243	36810
	3 – 6 mm	–	36244	36815
	6 – 8 mm	–	36245	36820
	8 – 11 mm	–	36246	–
	11 – 17 mm	–	36247	–
	17 – 22 mm	–	36248	–
	22 – 30 mm	–	36249	–
SK	30 – 38 mm	–	36250	–
	38 – 48 mm	–	36252	–
	3 – 8 mm	–	–	36500.002
SK	4 – 13.5 mm	–	–	36502.002
	10 – 20 mm	–	–	36504
	15 – 32 mm	–	–	36506
PU	10	10	10	10

EMC shield clamps for 10 × 3 mm bus bars with strain relief function



PFSZ-M|MSKL

Whenever a cable shielding is required with the possibility of grounding, EMC shield clamps can be used. Shield clamps are easy to use and effective in dissipating conducted disturbances.

Optional strain relief function: the cable is fixed via the cable jacket using cable ties.

Assembly

The shield clamps can be mounted on 10 × 3 mm bus bars.

Advantages & benefits

- Integrated strain relief function
- Large cable shield contact area
- Easy, tool-free assembly
- The spring design requires no adjustments and will permanently maintain contact to the cable shield
- Designed for high density applications
- Shock and vibration resistant, maintenance free
- Double strain relief: acc. to PROFINET installation guidelines

Specifications

Material

MSKL-clamp,	
SKL-clamp	Spring steel, zinc plated
PFS-foot	Spring steel
SK-bracket	Sheet steel, galvanically zinc plated
Bus bar	Cu, tin plated, current load 140 A

Suitable for

KEL-EMV-PF cable assembly bracket	225
MF Supports for bus bars	293

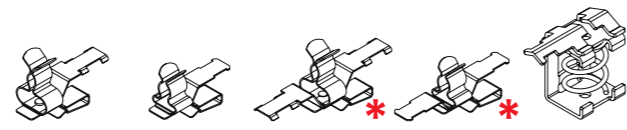

	PFSZ-M MSKL	PFSZ SKL	PFS2Z-M MSKL	PFS2Z SKL	SS SKZ
Clamping range	Order No.	Order No.	Order No.	Order No.	Order No.
MSKL	3 – 12 mm	37630	–	37630.150	–
	8 – 18 mm	37632	–	37632.150	–
SKL	1.5 – 3 mm	–	36787.1	–	36787.151
	3 – 6 mm	–	36787.2	–	36787.152
	6 – 8 mm	–	36787.3	–	36787.153
	8 – 11 mm	–	36787.4	–	36787.154
	11 – 17 mm	–	36787.5	–	36787.155
	17 – 22 mm	–	36787.6	–	36787.156
SKZ	3 – 8 mm	–	–	–	36235
	4 – 13.5 mm	–	–	–	36236
PU	10	10	10	10	10

* with double strain relief function

Bus bar 10 × 3 mm

Type	Order No.	PU
Bus bar 10 × 3 mm	10 × 3 × 1000 mm*	36100

* Other lengths available on request

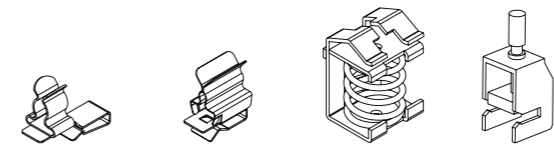

	PFS SKL	PFS SCL	SS SK	SKS	
Clamping range	Order No.	Order No.	Order No.	Order No.	
SKL	1.5 – 3 mm	36786.1	36611	–	
	3 – 6 mm	36786.2	36612	–	
	6 – 8 mm	36786.3	–	–	
	8 – 11 mm	36786.4	–	–	
	11 – 17 mm	36786.5	–	–	
	17 – 22 mm	36786.6	–	–	
SK	3 – 8 mm	–	–	36235.002	
	4 – 13.5 mm	–	–	36236.002	
	10 – 20 mm	–	–	36237	
	15 – 32 mm	–	–	36238	
SKS	2 – 5 mm	–	–	–	36282
	3 – 8 mm	–	–	–	36283
	3 – 14 mm	–	–	–	36284
	3 – 20 mm	–	–	–	36285
	5 – 28 mm	–	–	–	36286
	20 – 35 mm	–	–	–	36287
PU	10	10	10	10	

EMC shield clamps for 10 × 3 mm bus bars without strain relief function



PFS|SKL

Whenever a cable shielding is required with the possibility of grounding, EMC shield clamps can be used. Shield clamps are easy to use and effective in dissipating conducted disturbances.

Assembly

The shield clamps can be mounted on 10 × 3 mm bus bars.

Advantages & benefits

- Large cable shield contact area
- Easy, tool-free assembly
- The spring design requires no adjustments and will permanently maintain contact to the cable shield
- Designed for high density applications
- Shock and vibration resistant, maintenance free

Specifications

Material

MSKL-clamp,	
SKL-clamp	Spring steel, zinc plated
PFS-foot	Spring steel
SK-bracket	Sheet steel, galvanically zinc plated
Bus bar	Cu, tin plated, current load 140 A

Suitable for

KEL-EMV-PF cable assembly bracket	225
MF Supports for bus bars	293

EMC double shield clamps for 10 × 3 mm bus bars with strain relief function



PFSZ2|SKL

Whenever a cable shielding is required with the possibility of grounding, EMC shield clamps can be used. Shield clamps are easy to use and effective in dissipating conducted disturbances.

Optional strain relief function: the cable is fixed via the cable jacket using cable ties.

Assembly

The shield clamps can be mounted on 10 × 3 mm bus bars.

Advantages & benefits

- Integrated strain relief function
- Large cable shield contact area
- Easy, tool-free assembly
- The spring design requires no adjustments and will permanently maintain contact to the cable shield
- Designed for high density applications
- Shock and vibration resistant, maintenance free

Specifications

Material	
MSKL-clamp,	Spring steel, zinc plated
SKL-clamp	Spring steel
PFS-foot	Spring steel
Bus bar	Cu, tin plated, current load 140 A

Accessories

Bus bar	202
MF Supports for bus bars	293

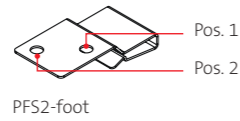

PFS2-foot

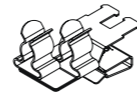

PFSZ2|SKL

Clamping range Pos. 1	Clamping range Pos. 2	Order No.
blank	1.5 – 3 mm	36789.01
blank	3 – 6 mm	36789.02
blank	6 – 8 mm	36789.03
blank	8 – 11 mm	36789.04
1.5 – 3 mm	blank	36789.10
1.5 – 3 mm	1.5 – 3 mm	36789.11
1.5 – 3 mm	3 – 6 mm	36789.12
1.5 – 3 mm	6 – 8 mm	36789.13
1.5 – 3 mm	8 – 11 mm	36789.14
3 – 6 mm	blank	36789.20
3 – 6 mm	1.5 – 3 mm	36789.21
3 – 6 mm	3 – 6 mm	36789.22
3 – 6 mm	6 – 8 mm	36789.23
3 – 6 mm	8 – 11 mm	36789.24
6 – 8 mm	blank	36789.30
6 – 8 mm	1.5 – 3 mm	36789.31
6 – 8 mm	3 – 6 mm	36789.32
6 – 8 mm	6 – 8 mm	36789.33
6 – 8 mm	8 – 11 mm	36789.34
8 – 11 mm	blank	36789.40
8 – 11 mm	1.5 – 3 mm	36789.41
8 – 11 mm	3 – 6 mm	36789.42
8 – 11 mm	6 – 8 mm	36789.43
PU		10

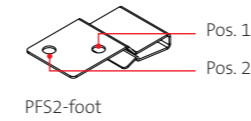

PFS2-foot



PFS2|SKL

Clamping range Pos. 1	Clamping range Pos. 2	Order No.
blank	1.5 – 3 mm	36788.01
blank	3 – 6 mm	36788.02
blank	6 – 8 mm	36788.03
blank	8 – 11 mm	36788.04
1.5 – 3 mm	blank	36788.10
1.5 – 3 mm	1.5 – 3 mm	36788.11
1.5 – 3 mm	3 – 6 mm	36788.12
1.5 – 3 mm	6 – 8 mm	36788.13
1.5 – 3 mm	8 – 11 mm	36788.14
3 – 6 mm	blank	36788.20
3 – 6 mm	1.5 – 3 mm	36788.21
3 – 6 mm	3 – 6 mm	36788.22
3 – 6 mm	6 – 8 mm	36788.23
3 – 6 mm	8 – 11 mm	36788.24
6 – 8 mm	blank	36788.30
6 – 8 mm	1.5 – 3 mm	36788.31
6 – 8 mm	3 – 6 mm	36788.32
6 – 8 mm	6 – 8 mm	36788.33
6 – 8 mm	8 – 11 mm	36788.34
8 – 11 mm	blank	36788.40
8 – 11 mm	1.5 – 3 mm	36788.41
8 – 11 mm	3 – 6 mm	36788.42
8 – 11 mm	6 – 8 mm	36788.43
PU		10

EMC double shield clamps for 10 × 3 mm bus bars without strain relief function



PFS2|SKL

Whenever a cable shielding is required with the possibility of grounding, EMC shield clamps can be used. Shield clamps are easy to use and effective in dissipating conducted disturbances.

Assembly

The shield clamps can be mounted on 10 × 3 mm bus bars.

Advantages & benefits

- Large cable shield contact area
- Easy, tool-free assembly
- The spring design requires no adjustments and will permanently maintain contact to the cable shield
- Designed for high density applications
- Shock and vibration resistant, maintenance free

Specifications

Material	
MSKL-clamp,	Spring steel, zinc plated
SKL-clamp	Spring steel
PFS-foot	Spring steel
Bus bar	Cu, tin plated, current load 140 A

Accessories

Bus bar	202
MF Supports for bus bars	293

EMC shield clamps for 30 mm C-rails with strain relief function

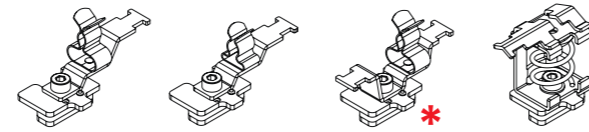

	SC LFZ-M MSKL Fixing hole M4	SC LFZ SKL Fixing hole M4	SC LFZ2-M MSKL Fixing hole M4	SC SKZ
	Order No.	Order No.	Order No.	Order No.
MSKL	Clamping range 3 – 12 mm	37612.100	–	37612.150
	8 – 18 mm	37614.100	–	37614.150
SKL	1.5 – 3 mm	–	36910.100	–
	3 – 6 mm	–	36915.100	–
	6 – 8 mm	–	36920.100	–
	8 – 11 mm	–	36925.100	–
	11 – 17 mm	–	36930.100	–
	17 – 22 mm	–	36935.100	37594.150
	22 – 30 mm	–	36940.100	37595.150
SKZ	3 – 8 mm	–	–	36696
	4 – 13.5 mm	–	–	36700
PU	10	10	10	10

* with double strain relief function

Whenever a cable shielding is required with the possibility of grounding, EMC shield clamps can be used. Shield clamps are easy to use and effective in dissipating conducted disturbances.

Optional strain relief function: the cable is fixed via the cable jacket using cable ties.

Assembly

The shield clamps can be mounted on 30 mm C-rails using the SC mounting foot (included in the shipment).

Advantages & benefits

- Integrated strain relief function
- Large cable shield contact area
- Easy, tool-free assembly
- The spring design requires no adjustments and will permanently maintain contact to the cable shield
- Designed for high density applications
- Shock and vibration resistant, maintenance free
- Double strain relief: acc. to PROFINET installation guidelines
- For mounting on all common C-rails with an opening dimension of 16–17 mm

Specifications

Material	
MSKL-clamp	Spring steel, zinc plated
SKL-clamp	Sheet steel, galvanically zinc plated
LFZ foot	Sheet steel, galvanically zinc plated Fixing hole M4
SC foot	Sheet steel, galvanically zinc plated
SK-bracket	Sheet steel, galvanically zinc plated



SC foot single for C-rail
PU: 10, Order No. 36220



Screw-foot loose, for 30 mm DIN-rail shape C (width of mouth: 16 – 17 mm) with twist protection notch
PU: 10, Order No. 36231

SC-foot: space-saving design enables high cable density. Mounting foot adjusts itself when tightening the screw.

EMC shield clamps for 30 mm C-rails without strain relief function

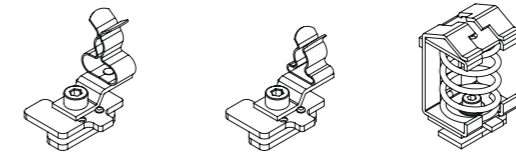

	SC LF MSKL Fixing hole M4	SC LF SKL Fixing hole M4	SC SK
	Order No.	Order No.	Order No.
MSKL	Clamping range 3 – 12 mm	37608.100	–
	8 – 18 mm	37610.100	–
SKL	1.5 – 3 mm	–	36251.100
	3 – 6 mm	–	36253.100
	6 – 8 mm	–	36255.100
	8 – 11 mm	–	36256.100
	11 – 17 mm	–	36257.100
	17 – 22 mm	–	36258.100
	22 – 30 mm	–	36259.100
SK	3 – 8 mm	–	36696.002
	4 – 13.5 mm	–	36700.002
	10 – 20 mm	–	36704
	15 – 32 mm	–	36708
PU	10	10	10

Whenever a cable shielding is required with the possibility of grounding, EMC shield clamps can be used. Shield clamps are easy to use and effective in dissipating conducted disturbances.

Assembly

The shield clamps can be mounted on 30 mm C-rails using the SC mounting foot (included in the shipment).

Advantages & benefits

- Large cable shield contact area
- Easy, tool-free assembly
- The spring design requires no adjustments and will permanently maintain contact to the cable shield
- Designed for high density applications
- Shock and vibration resistant, maintenance free

Specifications

Material	
MSKL-clamp	Spring steel, zinc plated
SKL-clamp	Sheet steel, galvanically zinc plated
LF foot	Sheet steel, galvanically zinc plated Fixing hole M4
SC foot	Sheet steel, galvanically zinc plated
SK-bracket	Sheet steel, galvanically zinc plated

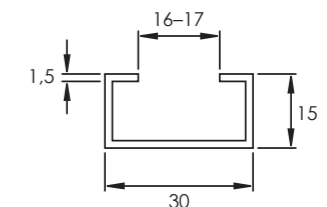

C-rail dimensions (mm)

EMC shield clamps for cable clamps for 30 mm C-rails



LFC|MSKL

The LFC shield clamp offers a space-saving solution for mounting on the C-rail.

The shield clamp LFC contacts the cable shield directly on the C-rail while the use of the existing cable clamp provides the strain relief.

4.1 Whenever a cable shielding is required with the possibility of grounding, EMC shield clamps can be used. Shield clamps are easy to use and effective in dissipating conducted disturbances.

Advantages & benefits

- Suitable for clamps that are mounted on C-rails
- Easy, tool-free assembly
- Space-saving assembly
- Large clamping range 3 – 30 mm
- Large cable shield contact area
- Shield contacting and strain relief are separated from each other
- For mounting on all common C-rails with an opening dimension of 16–17 mm

Specifications

Material Spring steel galvanised

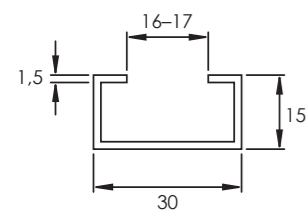

C-rail dimensions (mm)

	LFC MSKL	LFC SKL
Clamping range	Order No.	Order No.
MSKL	3 – 12 mm	37670.100
	8 – 18 mm	37671.100
SKL	17 – 22 mm	37672.100
	22 – 30 mm	37673.100
PU	10	10

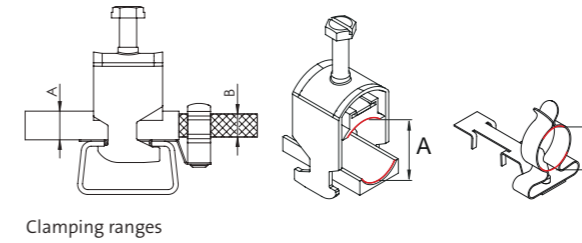

Type	Clamping range A Cable clamp (Ø on the cable sheath)	Clamping range B Shield clamp (Ø on the cable shield)	Order No.	PU
CC-LFC 6-13 MSKL 3-12	6 – 13 mm	3 – 12 mm	37680	10
CC-LFC 12-19 MSKL 8-18	12 – 19 mm	8 – 18 mm	37681	10
CC-LFC 18-23 SKL 17-22	18 – 23 mm	17 – 22 mm	37682	10
CC-LFC 23-32 SKL 22-30	23 – 32 mm	22 – 30 mm	37683	10
CC-LFC 32-38 SKL 30-38	32 – 38 mm	30 – 38 mm	37688	10
CC-LFC 38-42 SKL 30-38	38 – 42 mm	30 – 38 mm	37684	10
CC-LFC 42-50 SKL 38-48	42 – 50 mm	38 – 48 mm	37685	10
CC-LFC 50-64 SKL 44-56	50 – 64 mm	44 – 56 mm	37686	10
CC-LFC 50-64 SKL 56-68	50 – 64 mm	56 – 68 mm	37687	10



Product set of EMC shield clamps and cable clamps for 30 mm C-rails



CC-LFC|MSKL

Convenient product set consisting of the LFC EMC shield clamp for contacting the cable shield and discharging interference currents in combination with the matching CCL cable clamp for strain relief on the cable jacket.

The combination of two products helps to save space and material in the enclosure. The EMC connection of the cables no longer has to be made via an additional top hat DIN rail or bus bar.

Advantages & benefits

- Space-saving due to the combination of the LFC shield clamp with the CCL cable clamp
- Quick and easy assembly
- Large variety of clamping areas
- Large cable shield contact area
- Shield contacting and strain relief are separated from each other
- For mounting on all common C-rails with an opening dimension of 16–17 mm

Specifications

Material LFC: Spring steel galvanised
 Cable clamp: Steel galvanised

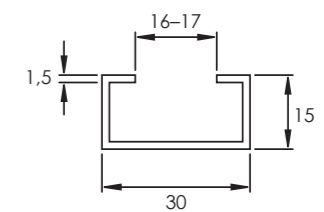

C-rail dimensions (mm)

EMC shield clamps for assembly on sheet edges with strain relief function



Whenever a cable shielding is required with the possibility of grounding, EMC shield clamps can be used. Shield clamps are easy to use and effective in dissipating conducted disturbances.

Optional strain relief function: the cable is fixed via the cable jacket using cable ties.

Assembly

The shield clamps are used where a screw connection is either not possible or wanted. It is simply clamped onto the sheet edge. The claws provide a secure grip, even in case of vibrations.

Advantages & benefits

- Integrated strain relief function
- Large cable shield contact area
- Easy, tool-free assembly
- The spring design requires no adjustments and will permanently maintain contact to the cable shield
- Designed for high density applications
- Maintenance free

Specifications

Material
SKL-clamp Spring steel, zinc plated
PFKZ foot Spring steel

Type A: For wall/sheet thickness 1.5 – 2 mm
Type B: For wall/sheet thickness 2 – 3 mm

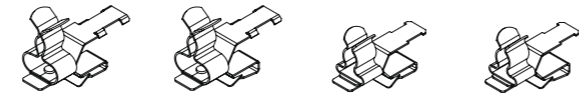

	PFKZ-A-M MSKL for sheet thickness 1.5 – 2 mm	PFKZ-B-M MSKL for sheet thickness 2 – 3 mm	PFKZ-A SKL for sheet thickness 1.5 – 2 mm	PFKZ-B SKL for sheet thickness 2 – 3 mm
Clamping range	Order No.	Order No.	Order No.	Order No.
MSKL	3 – 12 mm	37640	37650	–
	8 – 18 mm	37642	37652	–
SKL	1.5 – 3 mm	–	–	36779.1
	3 – 6 mm	–	–	36779.2
	6 – 8 mm	–	–	36779.3
	8 – 11 mm	–	–	36779.4
	11 – 17 mm	–	–	36779.5
	17 – 22 mm	–	–	36779.6
	22 – 30 mm	–	–	36779.7
PU	10	10	10	10

EMC shield clamps for assembly on sheet edges without strain relief function



Whenever a cable shielding is required with the possibility of grounding, EMC shield clamps can be used. Shield clamps are easy to use and effective in dissipating conducted disturbances.

Assembly

The shield clamps are used where a screw connection is either not possible or wanted. It is simply clamped onto the sheet edge. The claws provide a secure grip, even in case of vibrations.

Advantages & benefits

- Large cable shield contact area
- Easy, tool-free assembly
- The spring design requires no adjustments and will permanently maintain contact to the cable shield
- Designed for high density applications
- Maintenance free

Specifications

Material
SKL-clamp Spring steel, zinc plated
PFKZ foot Spring steel

Type A: For wall/sheet thickness 1.5 – 2 mm
Type B: For wall/sheet thickness 2 – 3 mm



	PFK-A SKL for sheet thickness 1.5 – 2 mm	PFK-B SKL for sheet thickness 2 – 3 mm
Clamping range	Order No.	Order No.
SKL	1.5 – 3 mm	36778.1
	3 – 6 mm	36778.2
	6 – 8 mm	36778.3
	8 – 11 mm	36778.4
	11 – 17 mm	36778.5
	17 – 22 mm	36778.6
	22 – 30 mm	36778.7
PU	10	10



Secure grip on metal sheets due to mounting claws

EMC double shield clamps for assembly on sheet edges with strain relief function



PFKZ2-foot

PFKZ2-A|SKL for sheet thickness 1.5 – 2 mm

PFKZ2-B|SKL for sheet thickness 2 – 3 mm

Clamping range Pos. 1	Clamping range Pos. 2	Order No.	Order No.
blank	1.5 – 3 mm	36781.01	36785.01
blank	3 – 6 mm	36781.02	36785.02
blank	6 – 8 mm	36781.03	36785.03
blank	8 – 11 mm	36781.04	36785.04
1.5 – 3 mm	blank	36781.10	36785.10
1.5 – 3 mm	1.5 – 3 mm	36781.11	36785.11
1.5 – 3 mm	3 – 6 mm	36781.12	36785.12
1.5 – 3 mm	6 – 8 mm	36781.13	36785.13
1.5 – 3 mm	8 – 11 mm	36781.14	36785.14
3 – 6 mm	blank	36781.20	36785.20
3 – 6 mm	1.5 – 3 mm	36781.21	36785.21
3 – 6 mm	3 – 6 mm	36781.22	36785.22
3 – 6 mm	6 – 8 mm	36781.23	36785.23
3 – 6 mm	8 – 11 mm	36781.24	36785.24
6 – 8 mm	blank	36781.30	36785.30
6 – 8 mm	1.5 – 3 mm	36781.31	36785.31
6 – 8 mm	3 – 6 mm	36781.32	36785.32
6 – 8 mm	6 – 8 mm	36781.33	36785.33
6 – 8 mm	8 – 11 mm	36781.34	36785.34
8 – 11 mm	blank	36781.40	36785.40
8 – 11 mm	1.5 – 3 mm	36781.41	36785.41
8 – 11 mm	3 – 6 mm	36781.42	36785.42
8 – 11 mm	6 – 8 mm	36781.43	36785.43
PU		10	10

Whenever a cable shielding is required with the possibility of grounding, EMC shield clamps can be used. Shield clamps are easy to use and effective in dissipating conducted disturbances.

Optional strain relief function: the cable is fixed via the cable jacket using cable ties.

Assembly

The shield clamps are used where a screw connection is either not possible or wanted. It is simply clamped onto the sheet edge. The claws provide a secure grip, even in case of vibrations.

Advantages & benefits

- Integrated strain relief function
- Large cable shield contact area
- Easy, tool-free assembly
- The spring design requires no adjustments and will permanently maintain contact to the cable shield
- Designed for high density applications
- Maintenance free

Specifications

Material
SKL-clamp Spring steel, zinc plated
PFKZ2 foot Spring steel

Type A: For wall/sheet thickness 1.5 – 2 mm
Type B: For wall/sheet thickness 2 – 3 mm

EMC double shield clamps for assembly on sheet edges without strain relief function



PFK2-foot

PFK2-A|SKL for sheet thickness 1.5 – 2 mm

PFK2-B|SKL for sheet thickness 2 – 3 mm

Clamping range Pos. 1	Clamping range Pos. 2	Order No.	Order No.
blank	1.5 – 3 mm	36780.01	36784.01
blank	3 – 6 mm	36780.02	36784.02
blank	6 – 8 mm	36780.03	36784.03
blank	8 – 11 mm	36780.04	36784.04
1.5 – 3 mm	blank	36780.10	36784.10
1.5 – 3 mm	1.5 – 3 mm	36780.11	36784.11
1.5 – 3 mm	3 – 6 mm	36780.12	36784.12
1.5 – 3 mm	6 – 8 mm	36780.13	36784.13
1.5 – 3 mm	8 – 11 mm	36780.14	36784.14
3 – 6 mm	blank	36780.20	36784.20
3 – 6 mm	1.5 – 3 mm	36780.21	36784.21
3 – 6 mm	3 – 6 mm	36780.22	36784.22
3 – 6 mm	6 – 8 mm	36780.23	36784.23
3 – 6 mm	8 – 11 mm	36780.24	36784.24
6 – 8 mm	blank	36780.30	36784.30
6 – 8 mm	1.5 – 3 mm	36780.31	36784.31
6 – 8 mm	3 – 6 mm	36780.32	36784.32
6 – 8 mm	6 – 8 mm	36780.33	36784.33
6 – 8 mm	8 – 11 mm	36780.34	36784.34
8 – 11 mm	blank	36780.40	36784.40
8 – 11 mm	1.5 – 3 mm	36780.41	36784.41
8 – 11 mm	3 – 6 mm	36780.42	36784.42
8 – 11 mm	6 – 8 mm	36780.43	36784.43
PU		10	10

Whenever a cable shielding is required with the possibility of grounding, EMC shield clamps can be used. Shield clamps are easy to use and effective in dissipating conducted disturbances.

Assembly

The shield clamps are used where a screw connection is either not possible or wanted. It is simply clamped onto the sheet edge. The claws provide a secure grip, even in case of vibrations.

Advantages & benefits

- Large cable shield contact area
- Easy, tool-free assembly
- The spring design requires no adjustments and will permanently maintain contact to the cable shield
- Designed for high density applications
- Maintenance free

Specifications

Material
SKL-clamp Spring steel, zinc plated
PFK2 foot Spring steel

Type A: For wall/sheet thickness 1.5 – 2 mm
Type B: For wall/sheet thickness 2 – 3 mm



Secure grip on metal sheets due to mounting claws

PCB|SKL EMC Shield clamps for printed circuit boards



PCB|SKL shield clamps are easy to use and effective in earthing single cable shields.

PCB|SKL consist of SKL clamps, fixed on a soldering foot that enables assembly on printed circuit boards. There are various designs to choose from.

4.1 Advantages & benefits

- The spring design requires no adjustments and will permanently maintain contact to the cable shield
- Large contact area

Specifications

Material	
SKL-clamp	Spring steel, zinc plated
PCB-foot	Brass, tin plated

SKL-clamp	
PCB-ET-4-V-4,1 SKL 3-6	Spring steel, tin plated

Type	Order No.	Height H [mm]	Height h1 [mm]	Width s [mm]	Pin h [mm]	Pin S [mm]	Grid a x b [mm]	Drill-hole d [mm]	PU
NEW PCB-4-V-6,8 MSKL 3-12 Clamping range 3–12 mm	37306	27	6.8	0.8	2.6	1.6	5 x 7.2	Ø 1.8	10
PCB-4-V-6,8 SKL 1.5-3 Clamping range 1.5 - 3 mm	36650.1	20	6.8	0.8	2.6	1.6	5 x 7.2	Ø 1.8	10
PCB-4-V-6,8 SKL 3-6 Clamping range 3 - 6 mm	36650.2	20	6.8	0.8	2.6	1.6	5 x 7.2	Ø 1.8	10
PCB-4-V-6,8 SKL 6-8 Clamping range 6 - 8 mm	36650.3	22	6.8	0.8	2.6	1.6	5 x 7.2	Ø 1.8	10
NEW PCB-4-V-6,8 SKL 8-11 Clamping range 8–11 mm	36650.4	27	6.8	0.8	2.6	1.6	5 x 7.2	Ø 1.8	10
PCB-4-V-12,5 SKL 1.5-3 Clamping range 1.5 - 3 mm	36656.1	25	12.5	1	4	1.6	5 x 10.1	Ø 1.8	10
PCB-4-V-12,5 SKL 3-6 Clamping range 3 - 6 mm	36656.2	26	12.5	1	4	1.6	5 x 10.1	Ø 1.8	10
PCB-4-V-12,5 SKL 6-8 Clamping range 6 - 8 mm	36656.3	27	12.5	1	4	1.6	5 x 10.1	Ø 1.8	10
PCB-ET-4-V-4,1 SKL 3-6 Clamping range 3 - 6 mm (one-piece)	36653.1	17.5	4.4	0.3	2.6	1.6	5 x 7.2	Ø 1.8	25

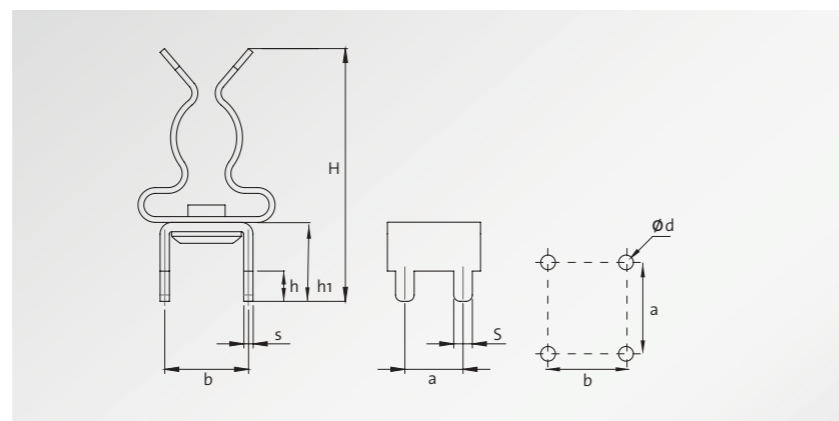

PCB-ET-4-V-4,1|SKL 3-6

STFZ|SKL EMC Terminal clamp for peripheral modules



STFZ-U|SKL

Application terminal clamp

STFZ|SKL

- Bosch Rexroth IP20 Inline Module
- PHOENIX CONTACT All terminals of the INLINE range. The terminals 1.4 and 2.4 must not be used for signal I/O.
- Pilz All PSSu-Modules with shield terminals 13 and 23
- Siemens All terminals of the ET200s range. Terminals 4 and 8 must not be used for signal I/O.
- TURCK For terminals of the BL20 I/O system.
- VIPA SLIO All terminals of the SLIO range. Terminals 4+8 must not be used for signal I/O.
- WAGO All terminals of the WAGO I/O Systems 750. Terminals 4 and 8 must not be used for signal I/O.
- Rockwell Automation / Allen-Bradley Series 1734

Further manufacturers upon request.

STFZ-U|SKL

- BECKHOFF EL 3122, ES 3122, ES 9100, ES 9410, KL 1114, KS 2134
- OMRON Series NX

STFZ-SP|SKL

- Siemens SIMATIC ET 200SP

The EMC terminal clamps STFZ|SKL combine the functions strain relief, cable guidance and earthing of signal cables. Available in two versions for 1 or 2 lines.

The STFZ2|SKL is used for analogue I/O modules using two actuators/sensors.

The STFZ EMC terminal clamp is compatible to bus modules listed on the left side.

For the SIMATIC ET 200SP module by Siemens icotek has developed a special terminal clamp STFZ-SP for 1 or 2 lines.



STFZ I/O Insert Tool

STFZ I/O Insert Tool for quick and easy mounting of STFZ terminal clamps.

Order No. 61430



STFZ-SP|SKL

STFZ-U|SKL

STFZ|SKL

STFZ | STFZ2

EMC Terminal clamp, single and double for various brands



The STFZ|SKL EMC terminal clamp provides strain relief, cable guidance and earthing for decentralised bus modules (see compatibility table page 212).

The STFZ2|SKL is used for analogue I/O modules using two actuators / sensors.

4.1 The EMC shield clamps as listed below are available to mount:
SKL 1.5-3 | SKL 3-6 | SKL 6-8

Advantages & benefits

- Earthing of signal cables close to the terminal
- Strain relief and cable management directly on the bus module

Specifications

Material
SKL-clamp Spring steel, zinc plated
STFZ-foot Spring steel

Accessories

STFZ I/O Insert Tool 215

Type	Shield diameter Pos. 1	Shield diameter Pos. 2	Order No.	PU
STFZ SKL with one shield clamp:				
STFZ SKL 1.5-3	1.5 - 3 mm	-	37510.1	10
STFZ SKL 3-6	3 - 6 mm	-	37510.2	10
STFZ SKL 6-8	6 - 8 mm	-	37510.3	10
STFZ2 SKL with two shield clamps:				
STFZ2 01	blank	1.5 - 3 mm	37505.01	10
STFZ2 02	blank	3 - 6 mm	37505.02	10
STFZ2 03	blank	6 - 8 mm	37505.03	10
STFZ2 10	1.5 - 3 mm	blank	37505.10	10
STFZ2 11	1.5 - 3 mm	1.5 - 3 mm	37505.11	10
STFZ2 12	1.5 - 3 mm	3 - 6 mm	37505.12	10
STFZ2 13	1.5 - 3 mm	6 - 8 mm	37505.13	10
STFZ2 20	3 - 6 mm	blank	37505.20	10
STFZ2 21	3 - 6 mm	1.5 - 3 mm	37505.21	10
STFZ2 22	3 - 6 mm	3 - 6 mm	37505.22	10
STFZ2 23	3 - 6 mm	6 - 8 mm	37505.23	10
STFZ2 30	6 - 8 mm	blank	37505.30	10
STFZ2 31	6 - 8 mm	1.5 - 3 mm	37505.31	10
STFZ2 32	6 - 8 mm	3 - 6 mm	37505.32	10
STFZ2 33	6 - 8 mm	6 - 8 mm	37505.33	10



STFZ2

STFZ-U | STFZ-SP | STFZ2-SP

EMC Terminal clamp, single and double for Siemens & Beckhoff modules



STFZ-SP|SKL

STFZ2-SP|SKL

The STFZ-SP|SKL EMC terminal clamp provides strain relief, cable guidance and earthing for decentralised bus modules SIMATIC ET 200SP by Siemens. STFZ2-SP|SKL is a version for analogue I/O modules using two actuators/sensors. STFZ-U terminal clamps for various Beckhoff modules.

4.1 The EMC shield clamps as listed below are available to mount:
SKL 1.5-3 | SKL 3-6 | SKL 6-8

Advantages & benefits

- Earthing of signal cables close to the terminal
- Strain relief and cable management directly on the bus module

Specifications

Material
SKL-clamp Spring steel, zinc plated
STFZ-SP-foot Spring steel

Accessories

STFZ I/O Insert Tool 215

Type	Shield diameter Pos. 1	Shield diameter Pos. 2	Order No.	PU
STFZ-SP SKL / STFZ-U SKL with one shield clamp:				
STFZ-SP SKL 1.5-3	1.5 - 3 mm	-	37512.1	10
STFZ-U SKL 1.5-3	1.5 - 3 mm	-	37514.1	10
STFZ-SP SKL 3-6	3 - 6 mm	-	37512.2	10
STFZ-U SKL 3-6	3 - 6 mm	-	37514.2	10
STFZ-SP SKL 6-8	6 - 8 mm	-	37512.3	10
STFZ-U SKL 6-8	6 - 8 mm	-	37514.3	10
STFZ2-SP with two shield clamps:				
STFZ2-SP 01	blank	1.5 - 3 mm	37507.01	10
STFZ2-SP 02	blank	3 - 6 mm	37507.02	10
STFZ2-SP 03	blank	6 - 8 mm	37507.03	10
STFZ2-SP 10	1.5 - 3 mm	blank	37507.10	10
STFZ2-SP 11	1.5 - 3 mm	1.5 - 3 mm	37507.11	10
STFZ2-SP 12	1.5 - 3 mm	3 - 6 mm	37507.12	10
STFZ2-SP 13	1.5 - 3 mm	6 - 8 mm	37507.13	10
STFZ2-SP 20	3 - 6 mm	blank	37507.20	10
STFZ2-SP 21	3 - 6 mm	1.5 - 3 mm	37507.21	10
STFZ2-SP 22	3 - 6 mm	3 - 6 mm	37507.22	10
STFZ2-SP 23	3 - 6 mm	6 - 8 mm	37507.23	10
STFZ2-SP 30	6 - 8 mm	blank	37507.30	10
STFZ2-SP 31	6 - 8 mm	1.5 - 3 mm	37507.31	10
STFZ2-SP 32	6 - 8 mm	3 - 6 mm	37507.32	10
STFZ2-SP 33	6 - 8 mm	6 - 8 mm	37507.33	10



STFZ2-SP



STFZ-U|SKL

EMC ServiceBox multi

Service box with assorted MSKL shield clamp



90% of all cable shields are contacted



The suitable EMC clamp is always readily available!

The EMC ServiceBox multi is very universal, especially when the cable diameter is unknown in advance. With the new ServiceBox multi you always have the right size on hand.

4.1 The EMC ServiceBox multi is perfect for installations and service calls. Retrofitting and maintenance can be carried out easily and quickly.

Order No. 88006

Content*

- MSKL / SKL for top hat DIN rails:**
 - Type SFZ-M|MSKL - sizes: 8 - 18 mm 10 × MSKL
 - Type SFZ-M|MSKL - sizes: 3 - 12 mm 20 × MSKL
 - Type SFZ|SKL - sizes: 1.5 - 3 mm 10 × SKL
- MSKL / SKL for assembly via screws:**
 - Type LFZ-M|MSKL - sizes: 8 - 18 mm 10 × MSKL
 - Type LFZ-M|MSKL - sizes: 3 - 12 mm 20 × MSKL
 - Type LFZ|SKL - sizes: 1.5 - 3 mm 10 × SKL
- MSKL for 10 × 3 mm bus bar:**
 - Type PFSZ-M|MSKL - sizes: 3 - 12 mm 10 × MSKL
- MSKL / SKL for clipping on metal sheets:**
 - Type PFKZ-B-M|MSKL - sizes: 1.5 - 8 mm 10 × MSKL
 - Type PFKZ-B|SKL 22 2 × SKL
- SKL for decentralised bus modules:**
 - Type STFZ|SKL - sizes: 3 - 6 mm 6 × SKL
- SKL for clipping on metal sheets**
 - Typ PFKZ-B|SKL 1,5-3 mm 3 × SKL
 - Typ PFKZ-B|SKL 3-6 mm 3 × SKL
 - Typ PFKZ-B|SKL 6-8 mm 3 × SKL
- EMC - Accessories:**
 - RLFZ - Clamp assembly 5× SKL 1 piece

* Subject to alterations

EMC ServiceBox

Service box with assorted SKL shield clamps



Exact gradations of the shield clamps



The suitable EMC clamp is always readily available!

The EMC ServiceBox is perfect for installations and service calls. Retrofitting and maintenance can be carried out easily and quickly

Order No. 88002

Content*

- SKL for top hat DIN rails:**
 - Type SFZ|SKL - sizes: 1.5 - 17 mm 15 × SKL
 - Type SFS|SKL - sizes: 1.5 - 8 mm 6 × SKL
 - SFZ-M|MSKL - sizes: 3-18 mm 4 × SKL
- SKL for assembly via screws:**
 - Type LFZ|SKL - sizes: 1.5 - 17 mm 21 × SKL
 - Type LFZ-U4|SKL - sizes: 1.5-11 mm 8 × SKL
 - Type LFZ-M|MSKL - sizes: 3-18 mm 4 × SKL
- SKL for 10 × 3 bus bar:**
 - Type PFSZ2|SKL 11 1 × SKL
 - Type PFSZ2|SKL 22 1 × SKL
 - Type PFSZ2|SKL 33 1 × SKL
- SKL for clipping on metal sheets:**
 - Type PFSZ|SKL - sizes: 1.5 - 11 mm 15 × SKL
 - Type PFSZ-M|MSKL - sizes: 3-18 mm 4 × SKL
- SKL for decentralised bus modules:**
 - STFZ|SKL - sizes: 3 - 6 mm 1 × SKL
 - STFZ2|SKL 23 1 × SKL
- SKL for Siemens module ET 200 SP:**
 - STFZ-SP|SKL - sizes: 3-6 mm 1 × SKL
 - STFZ2-SP|SKL 23 1 × SKL

* Subject to alterations

4.1

RLFZ-M | SC|RLFZ-M

EMC Clamp assembly with strain relief and a large clamping range



for screw mounting

The RLFZ-M range is a further development of the EMC clamp assembly which enables earthing and strain relief of up to 12 cable shields from 3-12 mm using only one shield clamp size.

There are 10 different carriers available which can be easily user configured with up to 12 MSKL 3-12 shield clamps.

Advantages & benefits

- Easy storage due to large clamping range 3-12 mm
- Designed for high density applications
- Possibility to configure custom specific EMC clamp assemblies
- Separate strain relief and EMC shield earthing
- Online design tool for EMC Clamp assembly on www.icotek.com

Specifications

Material	
MSKL-clamp	Spring steel, zinc plated
RLFZ-M-foot	Sheet steel, galvanically zinc plated
SC-foot	Sheet steel, galvanically zinc plated



Type SC: Mounted on screw-foot for DIN-rail shape C



SC foot single for C-rail
PU: 10, Order No. 36220



Try our EMC configurator: EMC cable shield clamps as single, double or multi solution – individually configurable for your applications on www.icotek.com



Type	Order No. for direct mounting	Order No. for C-rails*	Number of shield clamps	Length	Width	PU
RLFZ-M (x2)	38069.002	–	2× MSKL 3-12	36 mm	54.1 mm	1
RLFZ-M (x3)	38070.002	38070.100	3× MSKL 3-12	52 mm	54.1 mm	1
RLFZ-M (x4)	38071.002	38071.100	4× MSKL 3-12	73 mm	54.1 mm	1
RLFZ-M (x5)	38072.002	38072.100	5× MSKL 3-12	94 mm	54.1 mm	1
RLFZ-M (x6)	38073.002	38073.100	6× MSKL 3-12	115 mm	54.1 mm	1
RLFZ-M (x7)	38074.002	38074.100	7× MSKL 3-12	136 mm	54.1 mm	1
RLFZ-M (x8)	38075.002	38075.100	8× MSKL 3-12	157 mm	54.1 mm	1
RLFZ-M (x9)	38076.002	38076.100	9× MSKL 3-12	178 mm	54.1 mm	1
RLFZ-M (x10)	38077.002	38077.100	10× MSKL 3-12	199 mm	54.1 mm	1
RLFZ-M (x11)	38078.002	38078.100	11× MSKL 3-12	220 mm	54.1 mm	1
RLFZ-M (x12)	38079.002	38079.100	12× MSKL 3-12	241 mm	54.1 mm	1



Type	Order No. for direct mounting	Order No. for C-rails*	Number of shield clamps	Length	Width	PU
RLFZ (x3)	38005	38005.100	3× SKL	41.2 mm	44.4 mm	1
RLFZ (x4)	38010	38010.100	4× SKL	56.8 mm	44.4 mm	1
RLFZ (x5)	38015	38015.100	5× SKL	72.4 mm	44.4 mm	1
RLFZ (x6)	38020	38020.100	6× SKL	88 mm	44.4 mm	1
RLFZ (x7)	38025	38025.100	7× SKL	103.6 mm	44.4 mm	1
RLFZ (x8)	38030	38030.100	8× SKL	119.2 mm	44.4 mm	1
RLFZ (x9)	38035	38035.100	9× SKL	134.8 mm	44.4 mm	1
RLFZ (x10)	38040	38040.100	10× SKL	150.4 mm	44.4 mm	1
RLFZ (x11)	38045	38045.100	11× SKL	166 mm	44.4 mm	1
RLFZ (x12)	38050	38050.100	12× SKL	181.6 mm	44.4 mm	1



Type SC: Mounted on screw-foot for DIN-rail shape C*



Try our EMC configurator: EMC cable shield clamps as single, double or multi solution – individually configurable for your applications on www.icotek.com

RLFZ | SC|RLFZ

EMC Clamp assembly with strain relief

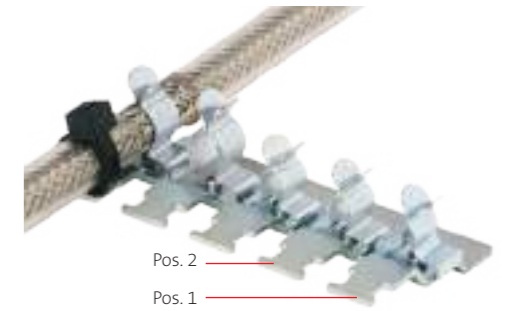

for screw mounting

The RLFZ range enables earthing and strain relief of up to 12 cables in a small space.

The combination of EMC shield earthing and strain relief is the key feature of this system.

There are 10 different carriers available which can be user configured with up to 12 SKL shield clamps.

The EMC shield clamps as listed below are available to mount:
SKL 1.5-3 | SKL 3-6 | SKL 6-8 | SKL 8-11

Advantages & benefits

- Designed for high density applications
- Possibility to configure custom specific EMC clamp assemblies
- Separate strain relief and EMC shield earthing
- Online design tool for EMC Clamp assembly

Specifications

Material	
SKL-clamp	Spring steel, zinc plated
RLFZ-foot	Carbon steel, galvanically zinc plated
SC-foot	Carbon steel, galvanically zinc plated

SF|RLFZ EMC Clamp assembly for 35 mm top hat DIN rail



Pos. 1
Pos. 2



Type	Order No. (unfitted)	Number of shield clamps	Length	Width	PU
SF RLFZ (x3)	38105	3× SKL	41.2 mm	70.7 mm	1
SF RLFZ (x4)	38110	4× SKL	56.8 mm	70.7 mm	1
SF RLFZ (x5)	38115	5× SKL	72.4 mm	70.7 mm	1
SF RLFZ (x6)	38120	6× SKL	88 mm	70.7 mm	1
SF RLFZ (x7)	38125	7× SKL	103.6 mm	70.7 mm	1
SF RLFZ (x8)	38130	8× SKL	119.2 mm	70.7 mm	1
SF RLFZ (x9)	38135	9× SKL	134.8 mm	70.7 mm	1
SF RLFZ (x10)	38140	10× SKL	150.4 mm	70.7 mm	1
SF RLFZ (x11)	38145	11× SKL	166 mm	70.7 mm	1
SF RLFZ (x12)	38150	12× SKL	181.6 mm	70.7 mm	1

The SF|RLFZ range is based upon the RLFZ clamp assembly, which is mounted on snap feet for 35 mm top hat DIN rails.

There are 10 different carriers available, which can be user configured with up to 12 SKL shield clamps.

4.1 The EMC shield clamps as listed below are available to mount:
SKL 1.5-3 | SKL 3-6 | SKL 6-8 | SKL 8-11

Advantages & benefits

- Designed for high density applications
- Possibility to configure custom specific EMC clamp assemblies
- Separate strain relief and EMC shield earthing
- Simple and tool-free mounting, easy assembly
- configure online on www.icotek.com

Specifications

Material
SKL-clamp Spring steel, zinc plated
RLFZ-foot Sheet steel, galvanically zinc plated



Try our EMC configurator: EMC cable shield clamps as single, double or multi solution – individually configurable for your applications on www.icotek.com

RLF EMC Clamp assembly

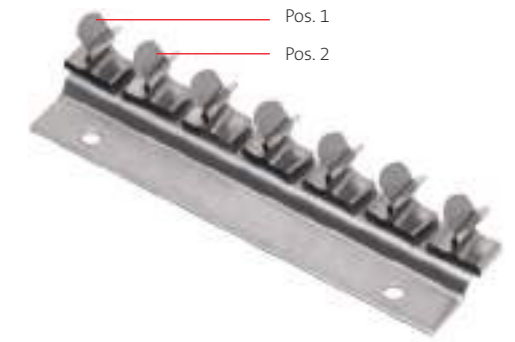

Pos. 1
Pos. 2



Type	Order No. (unfitted)	Number of shield clamps	Length	Width	PU
RLF (x3)	36965	3× SKL	46.2 mm	24 mm	1
RLF (x4)	36984	4× SKL	60.8 mm	24 mm	1
RLF (x5)	36958	5× SKL	72.4 mm	24 mm	1
RLF (x6)	36952	6× SKL	88 mm	24 mm	1
RLF (x7)	36963	7× SKL	103.6 mm	24 mm	1
RLF (x8)	36953	8× SKL	119.2 mm	24 mm	1
RLF (x9)	36985	9× SKL	140.8 mm	24 mm	1
RLF (x10)	36954	10× SKL	150.4 mm	24 mm	1
RLF (x11)	36955	11× SKL	166 mm	24 mm	1
RLF (x12)	36962	12× SKL	181.6 mm	24 mm	1

Comparable with the RLFZ clamp assembly, just without strain relief.

There are 10 different carriers available which can be user configured with up to 12 SKL shield clamps.

The EMC shield clamps as listed below are available to mount:
SKL 1.5-3 | SKL 3-6 | SKL 6-8 | SKL 8-11

Advantages & benefits

- Designed for high density applications
- Possibility to configure custom specific EMC clamp assemblies
- Online design tool for EMC Clamp assembly

Specifications

Material
SKL-clamp Spring steel, zinc plated
RLF-foot Stainless steel



Try our EMC configurator: EMC cable shield clamps as single, double or multi solution – individually configurable for your applications on www.icotek.com

4.1

KEL-EMC-Z

Cable assembly with strain relief



Type	Order No.	No. of teeth	Fastening	Fits with	PU
KEL-EMC-Z 16 4	36525	4	long side	KEL-(ER-)E4 KEL 16 x KEL-FA 16 x KEL-U 16 x KEL-ER 16 x KEL-QUICK 16	1
KEL-EMC-Z 24 5	36527	5	long side	KEL-(ER-)E5 KEL 24 x KEL-FA 24 x KEL-U 24 x KEL-ER 24 x KEL-QUICK 24	1
KEL-EMC-Z 183 4	36528	4	long side	KEL 183	1

Cable entry, EMC shield earthing and strain relief – all in one location!

Cables pass through the KEL cable entry frame and lead directly to the EMC clamps and strain relief.

Simply insert the cable shield into the shield clamp and secure the cable jacket to the strain relief. Two separate functions (according to regulations) carried out quickly and easily!

Custom configurations are available for shield clamps up to 16 mm in diameter with minimal order quantities and lead time.

Advantages & benefits

- Large surface contact between cable shield and housing, especially on conductive coated surfaces
- Sealing by outer cable jacket – EMC earthing by cable shield (in acc. with regulations)
- Easily combines cable routing, EMC and strain relief due to the use of the same mounting holes
- Available without SKL shield clamps if only additional strain relief is required
- Mounting hole for earthing tape or PE connection

Specifications

Material Sheet steel, zinc plated

Compatible with

KEL-FA Cable entry frames	18 - 21
KEL-U Cable entry frames	14 - 16
KEL-ER Cable entry frames	10 - 12
KEL Cable entry frames	22 - 31
KEL-QUICK Cable entry frames	96 - 97
KEL 183 Cable entry frames	32

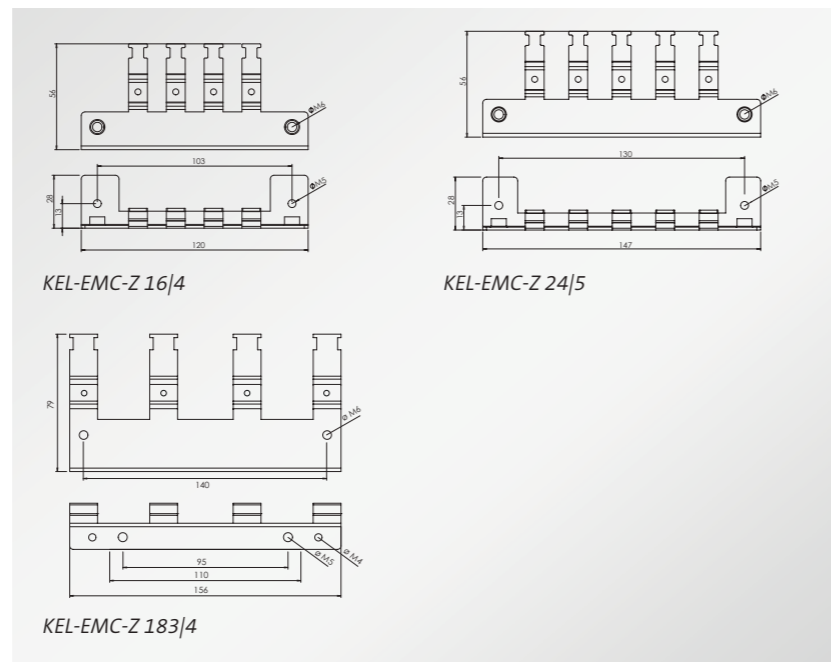

KEL-EMC-PF

Cable assembly, bracket version

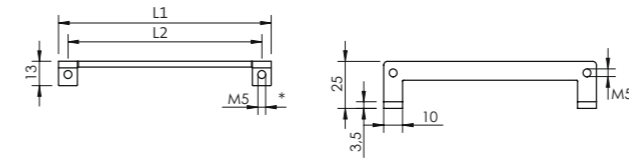

Type	Fits with	Order No.	Length L1	Length L2	PU
KEL-EMC-PFM 10	KEL(-U/-ER) 10 x KEL-FA 10 x KEL-QUICK 10 x	39184	93 mm	83 mm	1
KEL-EMC-PFM 16	KEL(-U/-ER) 16 x KEL-FA 16 x KEL-QUICK 16 x KEL-DPZ 16 x	39183	113 mm	103 mm	1
KEL-EMC-PFM 24	KEL(-U/-ER) 24 x KEL-FA 24 x KEL-QUICK 24 x KEL-DPZ 24 x KEL-DPU 24 x	39181	140 mm	130 mm	1
KEL-EMC-PF B4	KEL-(ER-)E2 KEL-QUICK-E2 KEL-(U-)B KEL-QUICK-B KEL-ER-B	39150	68 mm	58 mm	1
KEL-EMC-PF 10	KEL-(ER-)E3 KEL-QUICK-E3 KEL(-U/-ER) 10 x KEL-FA 10 x KEL-QUICK 10 x	39160	93 mm	83 mm	1
KEL-EMC-PF 16	KEL-(ER-)E4 KEL-QUICK-E4 KEL(-U/-ER) 16 x KEL-FA 16 x KEL-QUICK 16 x KEL-DPZ 16 x	39170	113 mm	103 mm	1
KEL-EMC-PF 24	KEL-(ER-)E5 KEL-QUICK-E5 KEL(-U/-ER) 24 x KEL-FA 24 x KEL-QUICK 24 x KEL-DPZ 24 x KEL-DPZ-E KEL-DPU 24 x	39180	140 mm	130 mm	1
KEL-EMC-PF 183	KEL 183 KEL 183-E	39190	200 mm	95 / 190 mm	1



The EMC bracket combined with the matching PFS|SKL EMC shield clamp is perfect in conjunction with the KEL cable entry frame for alleviating interferences due to shields.

The EMC clamp is assembled inside the control panel. For this process the fixing screws for the assembly of the KEL frame on the panel are used. A female screw thread M5 is already integrated in the KEL-EMC-PF bracket.

Depending on the cable diameter, the corresponding PFS|SKL EMC shield clamp can be snapped onto the EMC bracket.

Advantages & benefits

- Supports a wide range of cable and wire sizes
- Large surface contact of the cable shield
- Permanent spring pressure on the cable shield
- Fast and easy assembly

Specifications

Material Sheet steel, galvanically zinc plated

Compatible with

KEL-FA Cable entry frames	18 - 21
KEL-U Cable entry frames	14 - 16
KEL-ER Cable entry frames	10 - 12
KEL Cable entry frames	22 - 31
KEL 183 Cable entry frames	32
KEL-QUICK Cable entry frames	96 - 97
KEL-BES Brush frames	298 - 299
KEL-DPU Cable entry plates	126 - 129
KEL-DPZ Cable entry plates	130 - 138
PFSZ SKL / PFSZ-M MSKL Shield clamps	202
PFS SKL Shield clamps	203



* M5 thread only applies to KEL-EMV-PF

KEL-EMC
Cable assembly



Installation of pre-terminated cables without shield interruption.

Advantages & benefits

- Direct, easy and quick contact to the enclosure
- Space saving, usable for up to 10 cables with the two row model
- Alternative to EMC cable glands, even for pre-terminated cables
- Low resistance shield contact

Specifications

Material Stainless steel

Compatible with

KEL-FA Cable entry frames	18 - 21
KEL-U Cable entry frames	14 - 16
KEL-ER Cable entry frames	10 - 12
KEL Cable entry frames	22 - 31
KEL-QUICK Cable entry frames	96 - 97
KEL-BES Brush frames	298

Type	Order No.	No. of teeth	Fastening	Fits with	PU
KEL-EMC-B	36520	2	long side	KEL-E2 KEL(-U/-B) x KEL-ER-B x KEL-QUICK-B2 B4	5
KEL-EMC 10	36522	3	long side	KEL-E3 KEL-FA 10 x KEL(-U) 10 x KEL-ER 10 x	5
KEL-EMC 16 4	36524	4	long side	KEL-E4 KEL-FA 16 x KEL(-U) 16 x KEL-ER 16 x KEL-QUICK 16	5
KEL-EMC 24 5	36526	5	long side	KEL-E5 KEL-FA 16 x KEL(-U) 24 x KEL-ER 24 x KEL-QUICK 24	5
KEL-EMC F	39110	3	long side	KEL(-U/-ER)-B x KEL(-U/-ER) 10 x KEL-FA 10 x KEL(-U/-ER) 16 x KEL-FA 16 x KEL(-U/-ER) 24 x KEL-FA 24 x	5

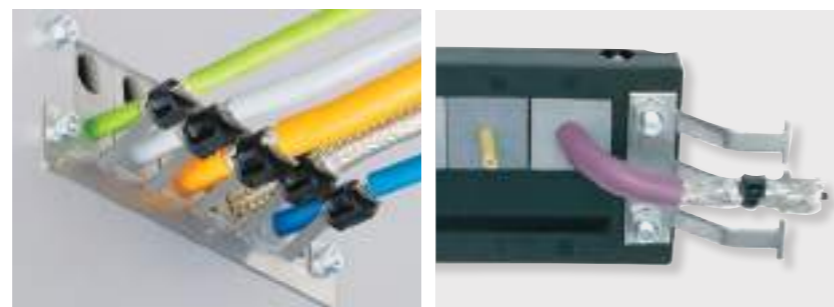

KVT-EMC
EMC bracket for cable glands



The KVT-EMC brackets in combination with the split cable glands KVT and QVT combine routing, EMC shield earthing and strain relief. The connection to the earth potential is possible via the enclosure wall or an earthing tape.

Cables pass through the split cable glands and lead directly into the EMC clamps.

Separate functions (according to regulations) carried out quickly and easily!

Advantages & benefits

- Simple and tool-free assembly
- Large contact area
- retrofitting possible
- Additional M5 hole for earthing tape

Specifications

Material Sheet steel, zinc plated

Compatible with

KVT Split cable glands	56 - 57
QVT Split cable glands	99 - 101

Type	Fits with	Order No.	Shield diameter	PU
KVT-EMC-16 SKL 1.5-3	QVT 16	37187.1	1.5 – 3 mm	5
KVT-EMC-16 SKL 3-6	QVT 16	37187.2	3 – 6 mm	5
KVT-EMC-16 SKL 6-8	QVT 16	37187.3	6 – 8 mm	5
KVT-EMC-16 SKL 8-11	QVT 16	37187.4	8 – 11 mm	5
KVT-EMC-25 SKL 1.5-3	KVT 25 QVT 25	37180.1	1.5 – 3 mm	5
KVT-EMC-25 SKL 3-6	KVT 25 QVT 25	37180.2	3 – 6 mm	5
KVT-EMC-25 SKL 6-8	KVT 25 QVT 25	37180.3	6 – 8 mm	5
KVT-EMC-25 SKL 8-11	KVT 25 QVT 25	37180.4	8 – 11 mm	5
KVT-EMC-32 SKL 1.5-3	KVT 32 QVT 32	37181.1	1.5 – 3 mm	5
KVT-EMC-32 SKL 3-6	KVT 32 QVT 32	37181.2	3 – 6 mm	5
KVT-EMC-32 SKL 6-8	KVT 32 QVT 32	37181.3	6 – 8 mm	5
KVT-EMC-32 SKL 8-11	KVT 32 QVT 32	37181.4	8 – 11 mm	5



KAFM-EMC EMC Strain relief plates



The EMC strain relief plate KAFM is practical for earthing interferences on the cable shield.

The cable assembly can be assembled on a mounting plate with screws, with SC foot on DIN-rails shape C or with SF or SK mounting foot on 35 mm top hat DIN-rails.

Type	Order No. Type SF	Order No. Type SK	Order No. Type SC	Order No. Type DH	Order No. loose rail	Length L1	Length L2	No. of teeth	PU
KAFM 2	36442	36432	36412	36482	36422	50.5	37.5	2	1
KAFM 4	36444	36434	36414	36484	36424	83.5	70.5	4	1
KAFM 6	36446	36436	36416	36486	36426	116.5	103.5	6	1
KAFM 8	36448	36438	36418	36488	36428	149.5	136.5	8	1
KAFM 10	36450	36440	36400	36490	36430	182.5	169.5	10	1
KAFM 16	36452	36470	36465	36460	36530	281.5	268.5	16	1
KAFM 29	36454	36471	36466	36462	36540	494.5	481.5	29	1
KAFM 59	36458	36472	36467	36464	36550	990	978	59	1
KAFM 59 zinc plated	36459	-	-	-	36562	990	978	59	1
SF	36230	Mounting foot single, for 35 mm top hat DIN-rail							10
SK	36232	Screw-foot single, for 35 mm top hat DIN-rail							10
SC	36231	Screw-foot single, for 30 mm DIN-rail shape C (width of mouth: 16–17 mm) with twist protection notch							10
Bushing DH	36234	Distance bushing 8 mm high							10

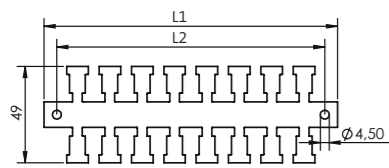

Specifications

Material Stainless steel



SC-foot with twist protection notch: space-saving design enables high cable density.

Mounting foot adjusts itself when tightening the screw.



Type SF: Mounted on snap foot for top hat DIN-rail



Type SC: Mounted on screw-foot for DIN-rail shape C



Type SK: Mounted on screw-foot for top hat DIN-rail



Type DH: Mounted on bushing for flexible fixation on bottom sheet

ZL|SB-EMC Shield plate for ZL strain relief plates



The shield plates ZL|SB-EMC provide shield earthing in addition to strain relief.

Affix the corresponding shield plates to ZL strain relief plates. The shield plate contacts the cable shield with the earth potential.

The result is a secure low resistance connection between cable shield and earth.

ZL strain relief plates offered separately.

Type	Model	Order No.	Fits with	Length L1	Length L2	PU
ZL 39 SB-EMC-1	single-row	36322	ZL 39	42 mm	19.5 mm	10
ZL 39 SB-EMC-2	double-row	37150	ZL 39	42 mm	19.5 mm	10
ZL 60 SB-EMC-1	single-row	36328	ZL 60	64 mm	43.5 mm	10
ZL 60 SB-EMC-2	double-row	37152	ZL 60	64 mm	43.5 mm	10
NEW ZL 70 SB-EMC-1	single-row	36323	ZL 70	72.2 mm	43.5 mm	10
ZL 87 SB-EMC-1	single-row	36324	ZL 87	90 mm	68 mm	10
ZL 87 SB-EMC-2	double-row	37154	ZL 87	90 mm	68 mm	10
ZL 103 SB-EMC-1	single-row	36332	ZL 103	106 mm	84 mm	10
ZL 103 SB-EMC-2	double-row	37156	ZL 103	106 mm	84 mm	10
ZL 121 SB-EMC-1	single-row	36330	ZL 121	124 mm	102.5 mm	10
ZL 121 SB-EMC-2	double-row	37158	ZL 121	124 mm	102.5 mm	10
ZL 140 SB-EMC-1	single-row	36326	ZL 140	142 mm	121 mm	10
ZL 140 SB-EMC-2	double-row	37159	ZL 140	142 mm	121 mm	10

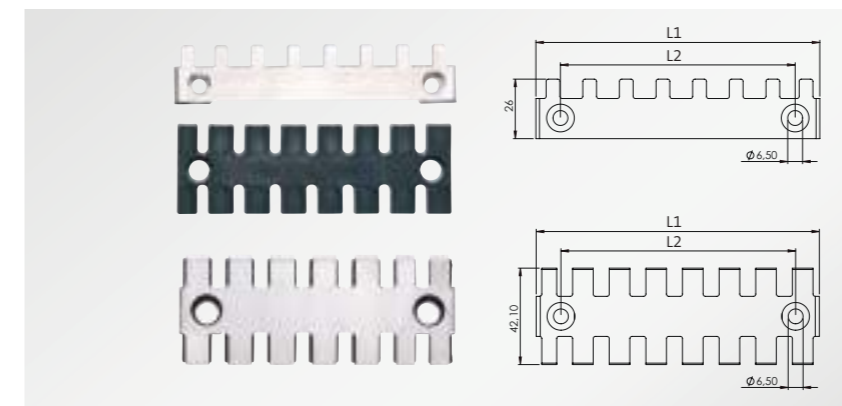

Specifications

Material
Shield plate Stainless steel

Compatible with

SF ZL Strain relief plates	174
ZL Strain relief plates	170
ZL-AB Strain relief plates	171

MB Earthing tapes



Manufactured with highly flexible E-Cu stranded wires with connecting end pads made of tinned copper strips.

The minimum transition and connecting resistance makes them perfectly suitable for use as earthing tapes.

Earthing Tapes are available with M4, M5, M6, M8 or M10 connections and in some sizes with both connection sizes combined.

Type	Order No.	Distance L [mm]	Cross-section mm ²	Hole size	PU
Cross-section 6 mm²					
MB 100 6 M4	32695	100	6	M4	1
MB 100 6 M6	32700	100	6	M6	1
MB 150 6 M4	39710	150	6	M4	1
MB 150 6 M6	32701	150	6	M6	1
MB 200 6 M4	32707	200	6	M4	1
MB 200 6 M6	32702	200	6	M6	1
MB 250 6 M6	32706	250	6	M6	1
MB 300 6 M6	32703	300	6	M6	1
MB 400 6 M6	32704	400	6	M6	1
MB 500 6 M6	32705	500	6	M6	1
Cross-section 10 mm²					
MB 100 10 M6	32730	100	10	M6	1
MB 100 10 M6 + M4	39711	100	10	M6 + M4	1
MB 100 10 M8	32731	100	10	M8	1
MB 150 10 M5	32709	150	10	M5	1
MB 150 10 M5 + M6	32746	150	10	M5 + M6	1
MB 150 10 M8	32732	150	10	M8	1
MB 200 10 M5	32744	200	10	M5	1
MB 200 10 M6	32733	200	10	M6	1
MB 200 10 M6 + M8	32741	200	10	M6 + M8	1
MB 200 10 M8	32734	200	10	M8	1
MB 250 10 M6 + M8	32742	250	10	M6 + M8	1
MB 300 10 M6	32735	300	10	M6	1
MB 300 10 M6 + M8	32743	300	10	M6 + M8	1
MB 300 10 M8	32736	300	10	M8	1
MB 400 10 M4	32878	400	10	M4	1
MB 400 10 M6	32737	400	10	M6	1
MB 400 10 M8	32738	400	10	M8	1
MB 500 10 M6	32739	500	10	M6	1

MB Earthing tapes



Connecting end pads (copper)

Advantages & benefits

- Available in a variety of lengths and cross-sections
- Low impedances
- UL 467 listed

Specifications

Material: Cu-ETP with connecting end pads
Pads made of tinned copper strips

Current Load

Cross-section	Current load
6 mm ²	67 – 80 A
10 mm ²	89 – 106 A
16 mm ²	132 – 157 A
25 mm ²	177 – 210 A
35 mm ²	230 – 275 A
50 mm ²	280 – 350 A
70 mm ²	338 – 403 A

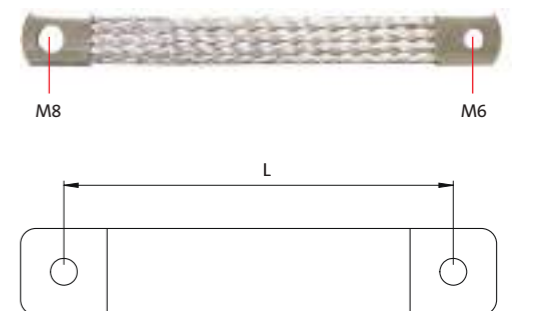

Type	Order No.	Distance L [mm]	Cross-section mm ²	Hole size	PU
Cross-section 16 mm²					
MB 100 16 M6	32760	100	16	M6	1
MB 100 16 M6 + M8	32758	100	16	M6 + M8	1
MB 100 16 M8	32761	100	16	M8	1
MB 100 16 M10	32759	100	16	M10	1
MB 150 16 M6	32762	150	16	M6	1
MB 150 16 M8	32763	150	16	M8	1
MB 200 16 M6	32764	200	16	M6	1
MB 200 16 M5 + M6	32776	200	16	M5 + M6	1
MB 200 16 M6 + M8	32773	200	16	M6 + M8	1
MB 200 16 M8	32765	200	16	M8	1
MB 250 16 M8	32766	250	16	M8	1
MB 250 16 M6 + M8	32774	250	16	M6 + M8	1
MB 300 16 M6	32767	300	16	M6	1
MB 300 16 M6 + M8	32775	300	16	M6 + M8	1
MB 300 16 M8	32768	300	16	M8	1
MB 350 16 M8	32769	350	16	M8	1
MB 350 16 M5 + M6	32777	350	16	M5 + M6	1
MB 400 16 M6	32873	400	16	M6	1
MB 400 16 M8	32770	400	16	M8	1
MB 500 16 M8	32771	500	16	M8	1
MB 600 16 M8	32772	600	16	M8	1
MB 1000 16 M8	32778	1000	16	M8	1
Cross-section 25 mm²					
MB 100 25 M10	32800	100	25	M10	1
MB 150 25 M10	32801	150	25	M10	1
MB 200 25 M8	32802	200	25	M8	1
MB 200 25 M10	32803	200	25	M10	1
MB 250 25 M8	32804	250	25	M8	1
MB 250 25 M10	32805	250	25	M10	1

MB
 Earthing tapes



Manufactured with highly flexible E-Cu stranded wires with connecting end pads made of tinned copper strips.

The minimum transition and connecting resistance makes them perfectly suitable for use as earthing tapes.

Earthing Tapes are available with M4, M5, M6, M8 or M10 connections and in some sizes with both connection sizes combined.

Type	Order No.	Distance L [mm]	Cross-section mm ²	Hole size	PU
Cross-section 25 mm²					
MB 300 25 M8	32806	300	25	M8	1
MB 300 25 M10	32807	300	25	M10	1
MB 350 25 M10	32808	350	25	M10	1
MB 400 25 M8	32809	400	25	M8	1
MB 500 25 M8	32810	500	25	M8	1
MB 500 25 M10	32812	500	25	M10	1
MB 600 25 M8	32811	600	25	M8	1
MB 800 25 M8	32815	800	25	M8	1
Cross-section 35 mm²					
MB 200 35 M10	32823	200	35	M10	1
MB 250 35 M10	32824	250	35	M10	1
MB 300 35 M10	32825	300	35	M10	1
Cross-section 50 mm²					
MB 150 50 M10	32847	150	50	M10	1
MB 200 50 M10	32848	200	50	M10	1
MB 250 50 M10	32849	250	50	M10	1
MB 300 50 M10	32850	300	50	M10	1
Cross-section 70 mm²					
MB 200 70 M10*	32868	200	70	M10	1
MB 300 70 M10*	32870	300	70	M10	1
MB 500 70 M10*	32872	500	70	M10	1

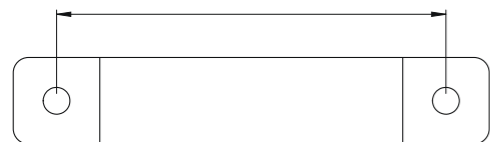

* No UL certification

EMC
 Customised solutions

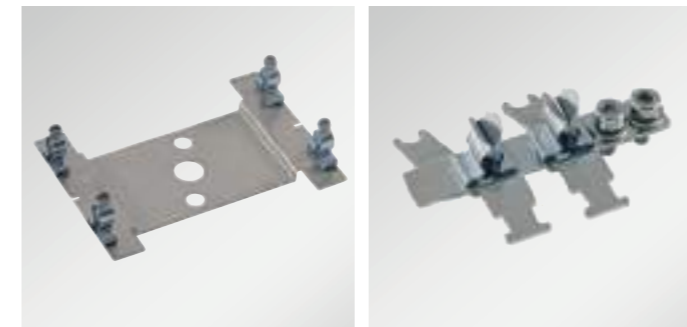
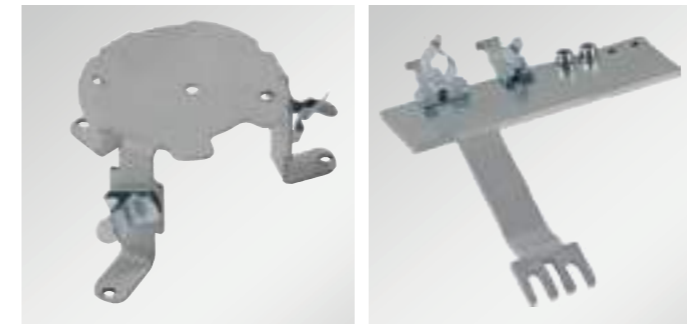

In addition to our standard product offering we offer customised solutions for your application – even for small quantities!

A wide range of standard clamp assemblies are already available (see pages 182 - 185).

If a standard EMC clamp assembly is not practicable in your case, a custom designed carrier for shield clamps can be supplied.

We look forward to sharing our ideas and custom EMC solutions with you.

Advantages & benefits

- Supply of custom designed carriers for SKL shield clamps
- Cost-effective even for small quantities
- Available for a wide range of cable diameters

 Contact us: pm@icotek.com

4.2 EMC cable entry systems

Solutions for conducted and field-bound disturbances



The industrial process technology demands increasing security against disturbances for electrical MCR facilities (measure, control, regulate). Special emphasis is being placed on the derivation of electromagnetic interference. A distinction is made between screening-related and field-related disturbances.

Screening-related interference is being transmitted directly from the source of interference to the cable shield of the supply or signal leads and then to the susceptible device. All capacitive and inductive influences of electrical or magnetic fields are called **field bound disturbances**. The field bound disturbances are being transferred, for example as a cable's electromagnetic field, from the source of interference to the susceptible device and received there, for instance, by a head acting as an antenna.

A large contact area of the cable shield for the derivation of the interference to a conductive housing wall combined with the shielding of the housing interior generally offers a good solution for both types of interference.

In case of conducted as well as field bound EMC disturbances, our cable entry system offers an effective way to divert and block those disturbances.

The key feature of icotek's system is the split frame and split grommets which provide quick, convenient and cost effective routing of pre-terminated and multi-conductor cables, hoses and conduits. The split frame and split grommets alleviate the need to cut and re-wire pre-terminated cables. Therefore, cable warranties are unaffected.

 EMC Split cable entry frames for cable diameters 2 to 33 mm EMC-KEL-DS 236 – 237	 EMC Split cable gland for screw-in assembly, M32, M63 for cable diameters 2 to 33 mm EMC-KVT-DS 238 – 239	 EMC Split cable entry frames for cable diameters 2 to 33 mm EMC-KEL 240 – 241
 Split EMC grommets small, single and multi for cables with and without connectors for cable diameters 2 to 16 mm EMC-KT 242	 Split EMC grommets large, single for cables with and without connectors for cable diameters 13 to 33 mm EMC-KT 243	 KT cable grommets split, for cables with and without connectors for cable diameters 1 – 35 mm 68, 72

4.2

4.2

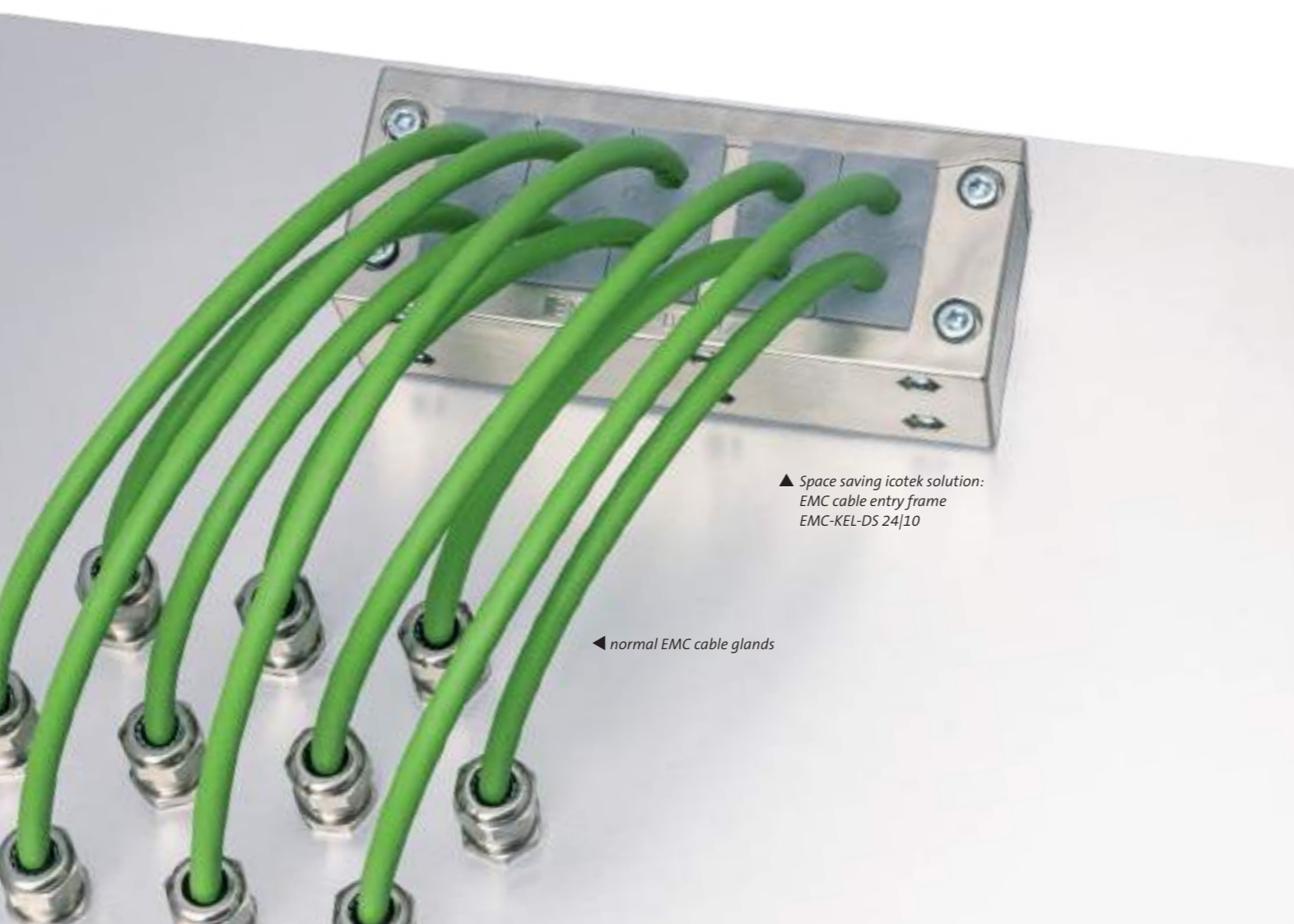

▲ Space saving icotek solution:
EMC cable entry frame
EMC-KEL-DS 24|10

◀ normal EMC cable glands

Test results: Conducted and field-bound disturbances

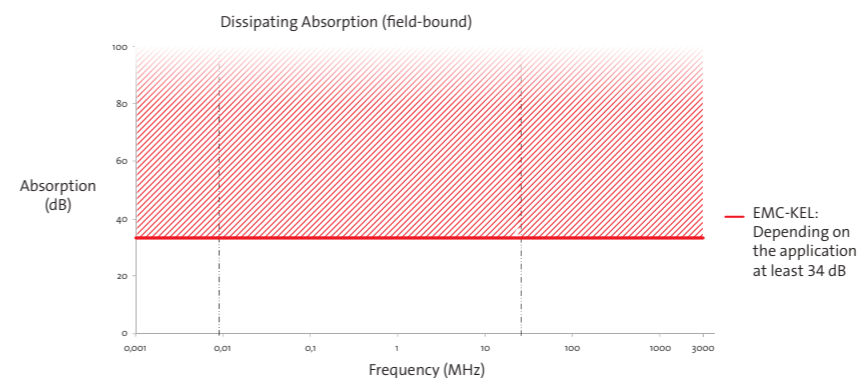
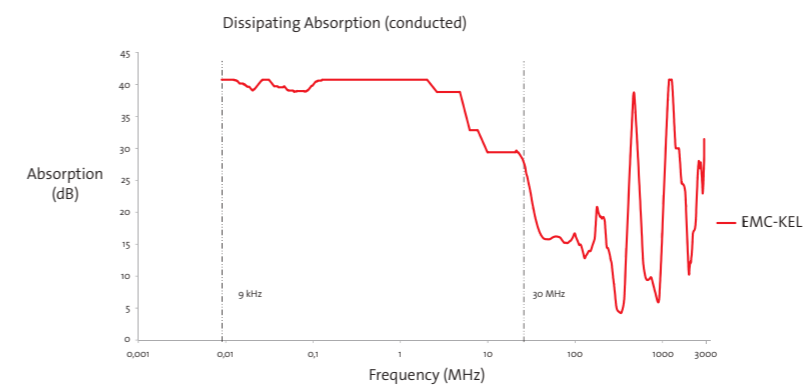

Conducted disturbances

The EMC-KEL shows during cable-bound disruptions stable attenuation values up to 40 dB in the frequency ranges from 9 kHz to 30 MHz.

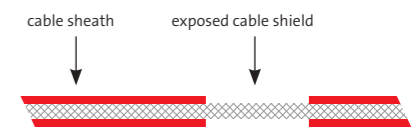

Field-bound disturbances

Regarding the field-bound disturbances and depending on the application, in the relevant frequency ranges up to 3 GHz constant measurements of at least 34 dB have been achieved. Below the attenuation range, the curve falls only at extreme high frequencies above 3 GHz.

EMC-KEL-DS
EMC Cable entry frames

EMC-KEL-DS
EMC Cable entry frames

The EMC cable entry frame EMC-KEL-DS has been metallised (galvanise coated) to create a conductive surface.

The front cable grommet (A) is used for strain relief and cable sealing on the cable jacket. The cable shield is contacted over 360° via the rear conductive grommet (B).

The contact between the EMV-KEL-DS and the conductive housing wall is realised via the included conductive flat gasket.



Advantages & benefits

- Perfect for already pre-terminated cables. The connector does not have to be removed for wiring
- Strain relief and sealing are separated from the EMC contact
- Both conducted and field-bound disturbances are reliably diverted
- Very attractive and scratch-resistant surface
- Contacting the cable shield over 360°
- EMC grommets made entirely from conductive elastomer
- Very good dissipation values
- Very good shielding effect with regard to EMC tightness
- Integrated strain relief
- Protection class IP55
- High cable density with multi grommets

Specifications

Material	Polyamide, highly conductive coating
Flame class	acc. to UL 94 HB
Temperature	-40°C to + 140°C
Properties	Halogen free, silicone free
Frame depth	40 mm
IP rating	IP55

Accessories

EMC-KT grommets	242 - 243
KT grommets	68 - 69

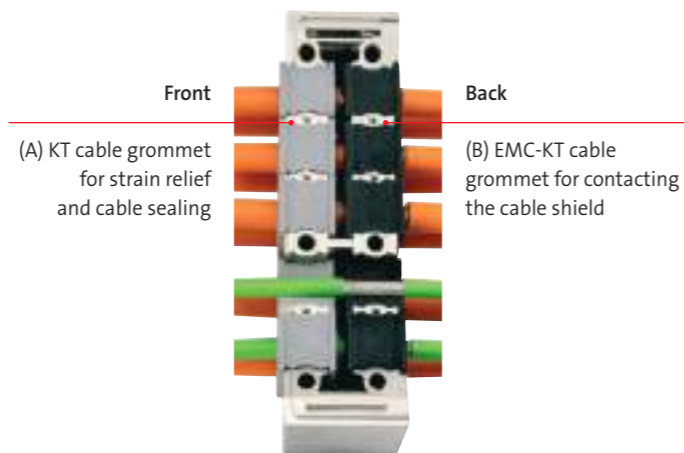

Description	Cut-out Drilling template	Type	Order No.	Cut-out mm	KT Grommets small large	EMC grommets small large	PU
EMC-KEL-DS 24 10		EMC-KEL-DS 24 10	99410	112 x 36 mm	10 -	10 -	1
EMC-KEL-DS 24 10 with threaded bushings M4		EMC-KEL-DS 24 10 with threaded bushings M4	99410.400	112 x 36 mm	10 -	10 -	1
EMC-KEL-DS 24 7		EMC-KEL-DS 24 7	99411	112 x 36 mm	6 1	6 1	1
EMC-KEL-DS 24 7 with threaded bushings M4		EMC-KEL-DS 24 7 with threaded bushings M4	99411.400	112 x 36 mm	6 1	6 1	1
EMC-KEL-DS 24 4		EMC-KEL-DS 24 4	99412	112 x 36 mm	2 2	2 2	1
EMC-KEL-DS 24 4 with threaded bushings M4		EMC-KEL-DS 24 4 with threaded bushings M4	99412.400	112 x 36 mm	2 2	2 2	1
EMC gasket size 24 conductive gasket for EMC-KEL-DS		EMC gasket size 24 conductive gasket for EMC-KEL-DS	98047	112 x 36 mm	-	-	1



EMC-KVT-DS
EMC Split cable gland

The split cable gland EMC-KVT-DS is based on the standard icotek KVT product. However, the EMC-KVT-DS has been metallised (galvanise coated) to create a conductive surface.

The first cable grommet (KT small) is used for strain relief and cable sealing on the cable jacket. The second grommet (EMC-KT small) contacts the cable shield at a full 360 degrees.

The conductive flat gasket included in the scope of delivery makes contact between the cable gland and the conductive housing wall. The EMC-KVT-DS can thus be fixed using a plastic lock nut. Alternatively, an additional contact to the metal wall can be made using a special EMC lock nut.

Advantages & benefits

- Perfect for already pre-terminated cables. The connector does not have to be removed for wiring
- Strain relief and sealing are separated from the EMC contact
- Both conducted and field-bound disturbances are reliably diverted
- Very attractive and scratch-resistant surface
- Contacting the cable shield over 360°
- EMC grommets made entirely from conductive elastomer
- Very good dissipation values
- Very good shielding effect with regard to EMC tightness
- Integrated strain relief
- Protection class IP55
- High cable density

Specifications

Material	Plastic, highly conductive coating
EMC locknut	Nickel-plated brass
Flame class	acc. to UL 94 HB
Temperature	-30°C to +90°C
Properties	Halogen free, silicone free
IP rating	IP55

Accessories

KT grommets	68 - 69
EMC-KT grommets	242 - 243
KGM	292



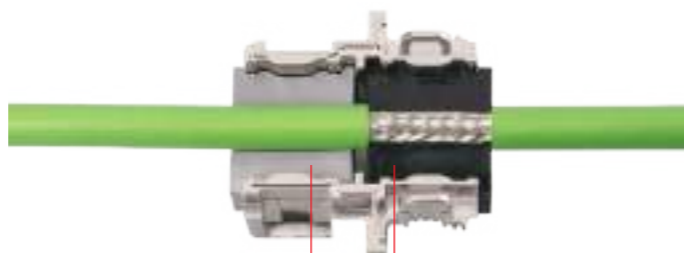
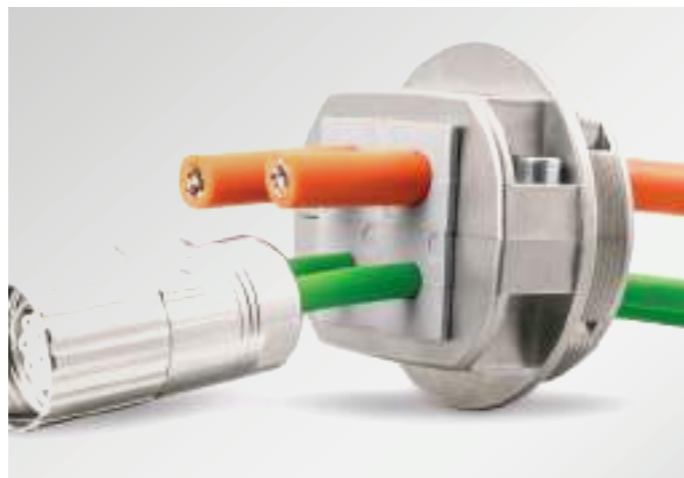

EMC locknut



Front Back
(A) KT cable grommet for strain relief and cable sealing
(B) EMC-KT cable grommet for contacting the cable shield

EMC-KVT-DS
EMC Split cable gland

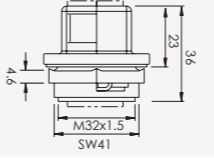
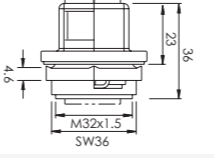
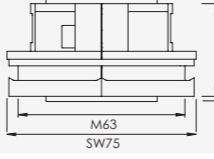
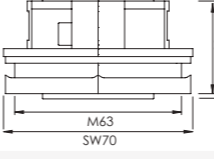
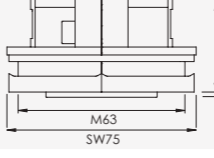
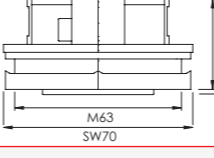
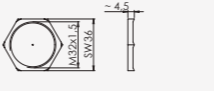
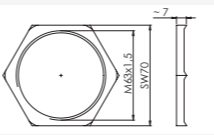

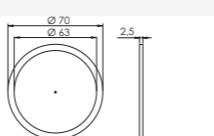
Description	Type	Order No.	KT Grommets small large	EMC grommets small large	Thread Thread length	PU
 EMC-KVT-DS 32 with plastic lock nut KGM 32		99431	1 -	1 -	M32 x 1.5 Length 14 mm	5
 EMC-KVT-DS 32 with EMC lock nut EMC-GM 32 Nickel-plated brass		99432	1 -	1 -	M32 x 1.5 Length 14 mm	5
 EMC-KVT-DS 63 1 with plastic lock nut KGM 63		99434	- 1	- 1	M63 x 1.5 Length 14 mm	1
 EMC-KVT-DS 63 1 with EMC lock nut EMC-GM 63 Nickel-plated brass		99435	- 1	- 1	M63 x 1.5 Length 14 mm	1
 EMC-KVT-DS 63 4 with plastic lock nut KGM 63		99436	4 -	4 -	M63 x 1.5 Length 14 mm	1
 EMC-KVT-DS 63 4 with EMC lock nut EMC-GM 63 Nickel-plated brass		99437	4 -	4 -	M63 x 1.5 Length 14 mm	1
 EMC-GM 32 EMC lock nut M32 for EMC-KVT-DS 32 Nickel-plated brass		99557	-	-	-	5
 EMC-GM 63 EMC lock nut M63 for EMC-KVT-DS 63 Nickel-plated brass		99558	-	-	-	1
 EMC gasket 32 conductive gasket for EMC-KVT-DS 32		99555	-	-	-	1
 EMC gasket 63 conductive gasket for EMC-KVT-DS 63		99556	-	-	-	1

EMC-KEL
EMC Cable entry frames

The EMC cable entry frames EMC-KEL are based on the KEL-U and KEL-E. Due to a conductive surface, disturbances in the cable shields on the control cabinet can be easily dissipated. Field bound disturbances are derived by the metallisation.

The cable entry system is easy to install. Cable grommets are placed into compartments and are securely fixed to the frame during assembly.

The EMC-KEL-U frames match exactly the cut-out dimensions for 16- and 24-pin standard industrial connectors. Either a cut-out of 36 mm or 46 mm in height can be chosen depending on the cables being routed.

The single-row versions EMC-KEL-E are particularly suited for flat connectors. The small frames are ideal for applications with limited space.

Between the EMC-KEL and the metal wall a conductive flat gasket (included) is mounted. The flange surface on the metal wall must be free of paint.

Advantages & benefits

- Both conducted and field-bound disturbances can be reliably diverted
- Very attractive and scratch-resistant surface
- Contacting the cable shield over 360°
- Grommets made entirely from conductive elastomer
- High cable density
- Very good dissipation values
- Very good shielding effect with regard to EMC tightness

Specifications

Material Polyamide, highly conductive coating
 Flame class UL 94 HB
 Temperature -40°C to + 140°C
 Properties Halogen free, silicone free
 Frame depth 17 mm

Accessories

EMC-KT grommets 242 - 243



EMC-KEL
EMC Cable entry frames



Description	Cut-out	Type	Order No.	Cut-out	Grommets EMC-KT small large	PU
		EMC-KEL-U 24 10	99400	36 × 112 mm	10 -	1
		EMC-KEL-U 24 4	99401	36 × 112 mm	2 2	1
		EMC-KEL-U 16 8	99402	36 × 86 mm	8 -	1
		EMC-KEL-E3	99420	24 × 65 mm	3 -	1
		EMC-KEL-E5	99422	24 × 112 mm	5 -	1
		EMC gasket size 24, conductive gasket	98047	36 × 112 mm	-	1

EMC-KT
Split EMC grommets,
small, single, multi



The cable grommets type EMC-KT are made of a very conductive elastomer. Thus, disturbances are dissipated from the cable shield directly via the grommet, the frame and the flat gasket. This ensures full-area protection against field-bound interference!

The model range EMC-KT small is designed for cable diameters from 2 to 16 mm. Cable grommets EMC-KT large accept a wide range of cable diameters from 13 to 33 mm.

When installing the small grommets in multiple rows, the flat sides should be facing each other.

Advantages & benefits

- Contacting the cable shield over 360°
- EMC grommets made entirely from conductive elastomer
- Enable routing of pre-terminated cables through cable entry frames and split cable glands
- Available for a large range of cable diameters

Specifications

Material	Elastomer, conductive
Flame class	in accordance with UL94-HB
Colour	black
Operating temperature	-30°C to +80°C -22°F to +176°F
Properties	Halogen free, silicone free

Accessories

ST Plugs 77

KT grommets can be found from page 68 on.

Description	Type	Order No.	Clamping range	PU
	EMC-KT 2	99459	2 – 3 mm	5
	EMC-KT 3	99460	3 – 4 mm	5
	EMC-KT 4	99461	4 – 5 mm	5
	EMC-KT 5	99462	5 – 6 mm	5
	EMC-KT 6	99463	6 – 7 mm	5
	EMC-KT 7	99464	7 – 8 mm	5
	EMC-KT 8	99465	8 – 9 mm	5
	EMC-KT 9	99466	9 – 10 mm	5
	EMC-KT 10	99467	10 – 11 mm	5
	EMC-KT 11	99468	11 – 12 mm	5
	EMC-KT 12	99469	12 – 13 mm	5
	EMC-KT 13	99470	13 – 14 mm	5
	EMC-KT 14	99471	14 – 15 mm	5
	EMC-KT 15	99472	15 – 16 mm	5
	EMC-BTK	99473	blank grommet	5
	EMC-KT 2 2	99500	2× ø 2 mm	5
	EMC-KT 2 3	99501	2× ø 3 mm	5
	EMC-KT 2 4	99493	2× ø 4 mm	5
	EMC-KT 2 5	99502	2× ø 5 mm	5
	EMC-KT 2 6	99503	2× ø 6 mm	5
	EMC-KT 4 2	99504	4× ø 2 mm	5
	EMC-KT 4 3	99505	4× ø 3 mm	5
	EMC-KT 4 4	99506	4× ø 4 mm	5
	EMC-KT 4 5	99507	4× ø 5 mm	5

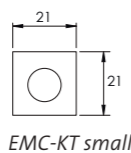

EMC-KT
Split EMC grommets,
large, single

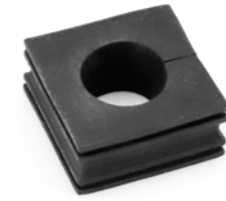

Description	Type	Order No.	Clamping range	PU
	EMC-KTG 13	99496	13 – 14 mm	5
	EMC-KTG 14	99497	14 – 15 mm	5
	EMC-KTG 15	99498	15 – 16 mm	5
	EMC-KT 16	99475	16 – 17 mm	5
	EMC-KT 17	99476	17 – 18 mm	5
	EMC-KT 18	99477	18 – 19 mm	5
	EMC-KT 19	99478	19 – 20 mm	5
	EMC-KT 20	99479	20 – 21 mm	5
	EMC-KT 21	99480	21 – 22 mm	5
	EMC-KT 22	99481	22 – 23 mm	5
	EMC-KT 23	99482	23 – 24 mm	5
	EMC-KT 24	99483	24 – 25 mm	5
	EMC-KT 25	99484	25 – 26 mm	5
	EMC-KT 26	99485	26 – 27 mm	5
	EMC-KT 27	99486	27 – 28 mm	5
	EMC-KT 28	99487	28 – 29 mm	5
	EMC-KT 29	99488	29 – 30 mm	5
	EMC-KT 30	99489	30 – 31 mm	5
	EMC-KT 31	99490	31 – 32 mm	5
	EMC-KT 32	99491	32 – 33 mm	5
	EMC-BTG	99495	blank grommet	5

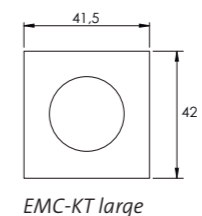

The cable grommets type EMC-KT are made of a very conductive elastomer. Thus, disturbances are dissipated from the cable shield directly via the grommet, the frame and the flat gasket. This ensures full-area protection against field-bound interference!

The model range EMC-KT small is designed for cable diameters from 2 to 16 mm. Cable grommets EMC-KT large accept a wide range of cable diameters from 13 to 33 mm.

When installing the small grommets in multiple rows, the flat sides should be facing each other.

Advantages & benefits

- Contacting the cable shield over 360°
- EMC grommets made entirely from conductive elastomer
- Enable routing of pre-terminated cables through cable entry frames and split cable glands
- Available for a large range of cable diameters

Specifications

Material	Elastomer, conductive
Flame class	in accordance with UL94-HB
Colour	black
Operating temperature	-30°C to +80°C -22°F to +176°F
Properties	Halogen free, silicone free

Accessories

ST Plugs 77

KT grommets can be found from page 68 on.

Assembly possibilities

	Var. 1	Var. 2	Var. 3	Var. 4	Var. 5
Outside	EMC-KEL	EMC-KEL	EMC-KEL	KEL-ER (U)	EMC-KEL
Inside	-	-	KEL-EMC-PFM	EMC-KEL	-
EMC: conducted	-	✓	✓	✓	**
EMC: field-bound	✓	✓	✓	✓	-
IP rating	IP54	not defined	IP54	IP66 (IP54)	not defined
Strain relief	✓	-	✓	✓	*

* Standard KT grommets only
 ** EMC-KT grommets only

Field-bound disturbances with strain relief

The EMC cable entry frame (EMC-KEL) is screwed to the outside of the housing.
 The cable shield is not exposed.



Conducted and field-bound disturbances

The EMC cable entry frame (EMC-KEL) is screwed to the outside of the housing. The cable shield is exposed in the area of the cable grommets.



Conducted and field-bound disturbances with strain relief

The EMC cable entry frame (EMC-KEL) is screwed to the outside of the housing.
 Inside the housing, the EMC bracket KEL-EMC-PFM is mounted and the exposed cable shield is placed.

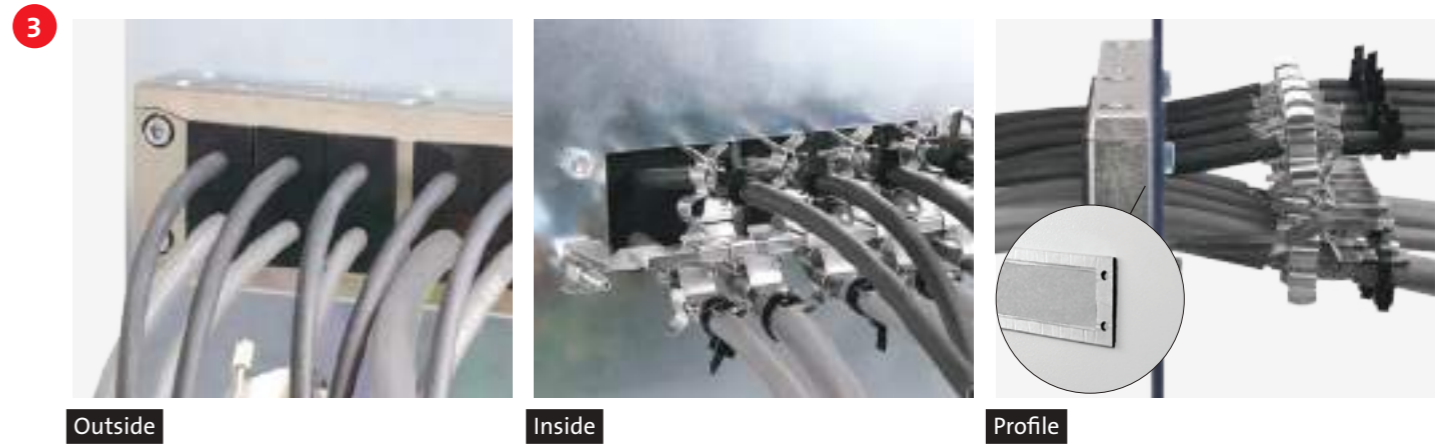

Conducted and field-bound disturbances with strain relief and IP66

A cable entry frame (e.g., KEL-ER or KEL-U) is bolted to the outside of the housing. Inside the housing, the EMC cable entry frame (EMC-KEL) is mounted and the cable shield is exposed in the area of the cable grommets.



Conducted disturbances with single strain relief

The EMC cable entry frame (EMC-KEL) is screwed to the outside of the housing.
 The cable shield is exposed in the area of the cable grommets. It's possible to use different grommets (KT & EMC-KT).



5 CONFIX™

Cable conduit system, cable protection conduits

IP54 RoHS compliant Made in Germany

The 90° angled conduit fitting CONFIX FWS is perfect for installation of parallel corrugated cable protection conduits, e.g. in machines, control panels or control cabinets. The liftable cover is tightly fixed by a hinge to the mounting box. Therefore, the system is very easy to handle.

Corrugated conduits CONFIX WS for cable routing are used where cables have to be protected from mechanical damage or certain weather conditions.

In addition, icotek offers split corrugated conduits CONFIX WST for routing pre-terminated cables and corresponding conduit clips CONFIX SH.

Advantages & benefits

1. Fast and easy assembly

The liftable cover of the bulkhead fitting CONFIX FWS is tightly fixed by a hinge to the mounting box. The system is therefore very easy to mount.

2. Easy to maintain

The split version of the corrugated conduits CONFIX WST offers the possibility of routing standard or pre-terminated cables in harsh environments.

3. Flexible

The corrugated conduits CONFIX WS can be used for various applications, depending on the material. Weather-resistant polyamide conduits for high mechanical requirements (indoor and outdoor use), polypropylene conduits with high resistance against acids/alkalis.

5.1 Conduit pass-through systems

	IP54
Bulkhead fittings, split IP54 for conduit screw connections/ direct conduit pickup	
CONFIX FWS	
	248

	IP54
Bulkhead fittings, split IP54 for conduit screw connections/ direct conduit pickup	
CONFIX FWS	
	249

5.2 Cable protection conduits

	
Corrugated conduits NW 7.5 – NW 50	
CONFIX WS	
	250 – 251

	
Corrugated conduits, split for cables with connectors NW 10 – NW 70	
CONFIX WST	
	252

	
Conduit clips for split corrugated conduits CONFIX WST	
CONFIX SH	
	253



CONFIX™ FWS Assembly

Installation of CONFIX FWS is quick and easy:

1. Use top screw(s) to mount the FWS
2. Insert conduit
3. Secure and complete installation with two side screws



CONFIX™ FWS-A
Bulkhead fittings
for conduit screw connections



The 90° angled conduit fitting CONFIX FWS is for installation of parallel corrugated cable protection conduits, e.g. in machines, control panels or control cabinets.

The liftable cover is tightly fixed by a hinge. Therefore the system is fast and easy to install.

CONFIX FWS is offered in the following versions:

CONFIX FWS-A with metric internal thread M16 to M50

CONFIX FWS-B with a grooved conduit clip for types with sizes NW 13, 17, 23, 29, 37 and 50.

The available colours are grey (RAL 7011) and black (RAL 9005).

5.1 Accessories

CONFIX WS conduits	250 - 251
Punches CONFIX	322

Type	Internal Thread	Hole Ø [mm]	Size (A × B) [mm]	Cut-out (C × D) [mm]	Drill. Templ. (E × F) [mm]	Order No.	PU
CONFIX FWS-A 16	M16 × 1.5	3 × 4.3	49 × 45	22 × 22.6	29 × 37	31381 (grey) 31380 (black)	10
CONFIX FWS-A 20	M20 × 1.5	3 × 4.3	49 × 45	22 × 22.6	29 × 37	31384 (grey) 31383 (black)	10
CONFIX FWS-A 25	M25 × 1.5	3 × 6.6	67 × 63	37 × 28	41.5 × 51.5	31387 (grey) 31386 (black)	10
CONFIX FWS-A 32	M32 × 1.5	4 × 6.6	85.5 × 76	41.9 × 40 r = 20	64.5 × 64.5	31390 (grey) 31389 (black)	10
CONFIX FWS-A 40	M40 × 1.5	4 × 6.6	97 × 92	48.3 × 48.4 r = 24.2	79.5 × 79.5	31393 (grey) 31392 (black)	5
CONFIX FWS-A 50	M50 × 1.5	4 × 6.6	111.5 × 100.5	53 × 60.5 r = 30.25	87.5 × 87.5	31396 (grey) 31395 (black)	5

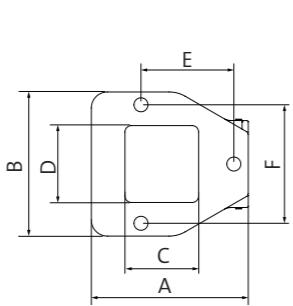

Size/Drilling template FWS-A 16 to 25

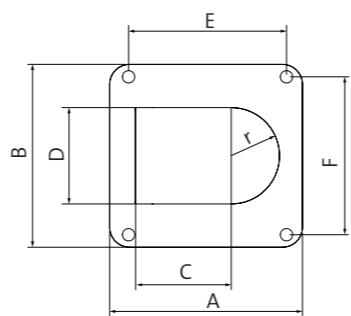

Size/Drilling template FWS-A 32 to 50



Matching sheet metal punches on p. 322



Metric internal thread for conduit screw connections



CONFIX™ FWS-B
Bulkhead fittings
for direct conduit pickup



Type	Dimension*	Hole Ø [mm]	Size (A × B) [mm]	Cut-out (C × D) [mm]	Drill. Templ. (E × F) [mm]	Order No.	PU
CONFIX FWS-B 11	NW 13	3 × 4.3	49 × 45	22 × 22.6	29 × 37	31411 (grey) 31410 (black)	10
CONFIX FWS-B 16	NW 17	3 × 4.3	49 × 45	22 × 22.6	29 × 37	31414 (grey) 31413 (black)	10
CONFIX FWS-B 21	NW 23	3 × 6.6	67 × 63	37 × 28	41.5 × 51.5	31417 (grey) 31416 (black)	10
CONFIX FWS-B 29	NW 29	4 × 6.6	85.5 × 76	41.9 × 40 r = 20	64.5 × 64.5	31420 (grey) 31419 (black)	10
CONFIX FWS-B 36	NW 37	4 × 6.6	97 × 92	48.3 × 48.4 r = 24.2	79.5 × 79.5	31423 (grey) 31422 (black)	5
CONFIX FWS-B 48	NW 50	4 × 6.6	111.5 × 100.5	53 × 60.5 r = 30.25	87.5 × 87.5	31426 (grey) 31425 (black)	5

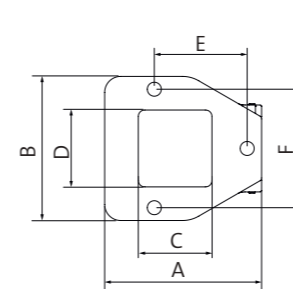

Size/Drilling template FWS-B 11 to 21

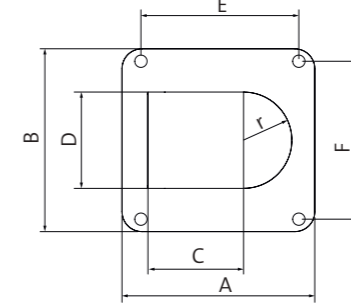

Size/Drilling template FWS-B 29 to 48



Grooved conduit clip



Fixed cover due to hinges



Matching sheet metal punches on p. 322

Advantages & benefits

- Hinged cover
- Fast and easy installation
- Functional design
- Protection class IP54

Specifications

Material	Polycarbonate (PC)
Colour	grey (RAL 7011) black (RAL 9005)
IP rating	IP54
Flame class	UL94-V0, self-extinguishing
Temperature	-30°C to +100°C (static)
Properties	Halogen free, silicone free

Accessories

CONFIX WS conduits	250 - 251
Punches CONFIX	322

* For parallel corrugated cable protection conduit with dimension (NW)

CONFIX™ WS

Corrugated conduits



Parallel corrugated conduits for cable routing are used where cables have to be protected from mechanical damage or certain weather conditions.

icotek provides conduits in sizes NW 7.5, 8.5, 10, 13, 17, 23, 29, 37, and 50. Conduits from size NW 13 can be mounted with CONFIX FWS bulkhead fittings.

Parallel corrugated conduits are available in 3 different versions:

- CONFIX WS-PA: Polyamide conduit for high mechanical requirements (e.g. engine compartments, car bodies, construction machines, ship building, rail transportation technology, switch cabinets).
→ Suitable for ground installation
- CONFIX WS-PAL (light): Polyamide conduit for high mechanical requirements
→ Suitable for suspended installation
- CONFIX WS-PP: Polypropylene conduit for use in engine compartments, car bodies and for static installation at machinery and plant engineering.
→ Advantages: Cost-effective, flame class UL94-V2, temperature resistant, resistant to chemicals

Type	External Ø	Internal Ø	Compatible with	Order No.	PU (Length)
CONFIX WS-G-PA-NW 7.5	Ø 10 mm	Ø 6.7 mm	–	■ 31550	50 m
CONFIX WS-B-PA-NW 7.5	Ø 10 mm	Ø 6.7 mm	–	■ 31570	50 m
CONFIX WS-G-PA-NW 8.5	Ø 11.4 mm	Ø 8.4 mm	–	■ 31552	50 m
CONFIX WS-B-PA-NW 8.5	Ø 11.4 mm	Ø 8.4 mm	–	■ 31572	50 m
CONFIX WS-G-PA-NW 10	Ø 13 mm	Ø 9.9 mm	–	■ 31554	50 m
CONFIX WS-B-PA-NW 10	Ø 13 mm	Ø 9.9 mm	–	■ 31574	50 m
CONFIX WS-G-PA-NW 13	Ø 15.8 mm	Ø 12.7 mm	CONFIX FWS-B 11	■ 31556	50 m
CONFIX WS-B-PA-NW 13	Ø 15.8 mm	Ø 12.7 mm	CONFIX FWS-B 11	■ 31576	50 m
CONFIX WS-G-PA-NW 17	Ø 21.2 mm	Ø 16.6 mm	CONFIX FWS-B 16	■ 31558	50 m
CONFIX WS-B-PA-NW 17	Ø 21.2 mm	Ø 16.6 mm	CONFIX FWS-B 16	■ 31578	50 m
CONFIX WS-G-PA-NW 23	Ø 28.3 mm	Ø 23.2 mm	CONFIX FWS-B 21	■ 31560	50 m
CONFIX WS-B-PA-NW 23	Ø 28.3 mm	Ø 23.2 mm	CONFIX FWS-B 21	■ 31580	50 m
CONFIX WS-G-PA-NW 29	Ø 34.5 mm	Ø 29 mm	CONFIX FWS-B 29	■ 31562	25 m
CONFIX WS-B-PA-NW 29	Ø 34.5 mm	Ø 29 mm	CONFIX FWS-B 29	■ 31582	25 m
CONFIX WS-G-PA-NW 37	Ø 42.4 mm	Ø 36 mm	CONFIX FWS-B 36	■ 31564	25 m
CONFIX WS-B-PA-NW 37	Ø 42.4 mm	Ø 36 mm	CONFIX FWS-B 36	■ 31584	25 m
CONFIX WS-G-PA-NW 50	Ø 54.5 mm	Ø 47.7 mm	CONFIX FWS-B 48	■ 31566	25 m
CONFIX WS-B-PA-NW 50	Ø 54.5 mm	Ø 47.7 mm	CONFIX FWS-B 48	■ 31586	25 m



Compatible with CONFIX FWS-B



CONFIX™ WS

Corrugated conduits

Type	External Ø	Internal Ø	Compatible with	Order No.	PU (Length)
CONFIX WS-B-PAL-NW 7.5	Ø 10 mm	Ø 6.7 mm	–	■ 31590	50 m
CONFIX WS-B-PAL-NW 8.5	Ø 11.4 mm	Ø 8.4 mm	–	■ 31592	50 m
CONFIX WS-B-PAL-NW 10	Ø 13 mm	Ø 9.9 mm	–	■ 31594	50 m
CONFIX WS-B-PAL-NW 13	Ø 15.8 mm	Ø 12.7 mm	CONFIX FWS-B 11	■ 31596	50 m
CONFIX WS-B-PAL-NW 17	Ø 21.2 mm	Ø 16.6 mm	CONFIX FWS-B 16	■ 31598	50 m
CONFIX WS-B-PAL-NW 23	Ø 28.3 mm	Ø 23.2 mm	CONFIX FWS-B 21	■ 31600	50 m
CONFIX WS-B-PAL-NW 29	Ø 34.5 mm	Ø 29 mm	CONFIX FWS-B 29	■ 31602	25 m
CONFIX WS-B-PAL-NW 37	Ø 42.4 mm	Ø 36 mm	CONFIX FWS-B 36	■ 31604	25 m
CONFIX WS-B-PAL-NW 50	Ø 54.4 mm	Ø 47.7 mm	CONFIX FWS-B 48	■ 31606	25 m
CONFIX WS-B-PP-NW 7.5	Ø 10 mm	Ø 7.1 mm	–	■ 31610	50 m
CONFIX WS-B-PP-NW 8.5	Ø 11.4 mm	Ø 8.4 mm	–	■ 31612	50 m
CONFIX WS-B-PP-NW 10	Ø 13 mm	Ø 9.9 mm	–	■ 31614	50 m
CONFIX WS-B-PP-NW 13	Ø 15.8 mm	Ø 12.7 mm	CONFIX FWS-B 11	■ 31616	50 m
CONFIX WS-B-PP-NW 17	Ø 21.2 mm	Ø 16.6 mm	CONFIX FWS-B 16	■ 31618	50 m
CONFIX WS-B-PP-NW 23	Ø 28.3 mm	Ø 23.2 mm	CONFIX FWS-B 21	■ 31620	50 m
CONFIX WS-B-PP-NW 29	Ø 34.5 mm	Ø 29 mm	CONFIX FWS-B 29	■ 31622	25 m
CONFIX WS-B-PP-NW 37	Ø 42.4 mm	Ø 36 mm	CONFIX FWS-B 36	■ 31624	25 m
CONFIX WS-B-PP-NW 50	Ø 54.5 mm	Ø 47.7 mm	CONFIX FWS-B 48	■ 31626	25 m

Specifications WS-PA

Material Polyamide (PA)
 Colour ■ black
 ■ grey
 Flame class UL 94-HB
 Temperature -40°C to +120°C
 Properties Halogen free, weather-resistant

Specifications WS-PAL

Material Polyamide (PA)
 Colour ■ black
 Flame class UL 94-HB
 Temperature -40°C to +120°C
 Properties Halogen free, weather-resistant

Specifications WS-PP

Material Polypropylene (PP)
 Colour ■ black
 Flame class UL 94 V-2, self-extinguishing
 Temperature -40°C to +135°C
 Properties Halogen free, high resistance against acids/alkalis

Compatible with

CONFIX FWS Bulkhead fitting 248 - 249

* For parallel corrugated cable protection conduit with dimension (NW)

CONFIX™ WST

Split corrugated conduits



The CONFIX WST is a two-part corrugated conduit that is perfect for routing cables with or without connectors in harsh environments.

In conjunction with e.g. KVT-W90, a high degree of flexibility is achieved. Numerous conduit sizes can be used thanks to the wide variety of split grommets offered.

The length of the CONFIX WST split corrugated conduit can be customized to your application. All conduits are available by the meter (0.5 m steps).

Advantages & benefits

- Containing pre-terminated cables, warranty of cable remains
- Retrofitting and maintenance carried out easily and quickly

Specifications

Material	Polypropylene, black
Flame class	UL 94-V2
Temperature	- 30°C to + 105°C
Properties	UV resistant

Compatible with

CONFIX SH Conduit clip	253
Cable entry systems for pre-terminated cables	6 - 121
Cable entry systems for standard cables	122 - 163



Individual lengths are possible!

Type	Order No.	Internal Ø	External Ø	Compatible grommets	Compatible with CONFIX FWS-B	Dimensions	Ring length*	Bending radius (static)
CONFIX WST NW 10	31200	8.4 mm	13.4 mm	KT 13	–	NW 10	50 m*	25 mm
CONFIX WST NW 14	31210	12.5 mm	18.5 mm	KT 18	31411 31410	NW 14	50 m*	35 mm
CONFIX WST NW 16	31215	16 mm	21.5 mm	KT 22	31414 31413	NW 16	50 m*	40 mm
CONFIX WST NW 20	31220	19.2 mm	25.30 mm	KT 25	–	NW 20	50 m*	45 mm
CONFIX WST NW 23	31230	23.4 mm	30.8 mm	KT 30	31417 31416	NW 23	50 m*	50 mm
CONFIX WST NW 29	31235	27.3 mm	35.5 mm	KTMB-P	31420 31419	NW 29	25 m*	90 mm
CONFIX WST NW 37	31240	31 mm	41.4 mm	KTMB-P	31423 31422	NW 37	25 m*	110 mm
CONFIX WST NW 45	31250	42.7 mm	54 mm	KTMB-Q	31426 31425	NW 45	25 m*	130 mm
CONFIX WST NW 70	31260	67 mm	79.8 mm	KEL-ULTRA flex	–	NW 70	10 m*	190 mm

CONFIX™ SH

Conduit clips for WST



Type	Order No.	Suitable conduit	Fixing hole	Width [mm]	Height [mm]	PU
CONFIX SH 10	31300	WST NW 10	M5	18.5	21	10
CONFIX SH 14	31310	WST NW 14	M5	24	25.5	10
CONFIX SH 16	31315	WST NW 16	M6	30	35	10
CONFIX SH 20	31320	WST NW 20	M6	35	36	10
CONFIX SH 23	31330	WST NW 23	M6	42	43.5	10
CONFIX SH 29	31335	WST NW 29	M6	48	48.5	10
CONFIX SH 37	31340	WST NW 37	M6	55	56.5	10
CONFIX SH 45	31350	WST NW 45	M6	67	68	10
CONFIX SH 70	31360	WST NW 70	M6	100	101	10

CONFIX SH Conduit clips are a one-piece clamping system to provide secure mounting points for corrugated conduit systems.

The clips are secured to their mounting position through a central mounting point with a hexagonal counter-bore.

Specifications

Material	Polyamide (PA), black
Flame class	UL94-V2, self-extinguishing
Temperature	- 40°C to + 120°C
Properties	Halogen free, silicone free

Compatible with

CONFIX WST Split corrugated conduit	252
-------------------------------------	-----



6 Enclosure accessories

Gland plates, flange plates & accessories

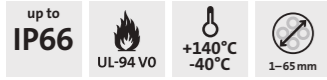

Ready-to-install **enclosure gland plates**, onto which the pre-assembled cable entry frames can be directly screwed, ensure quick and easy cable entry into the enclosure base. Cables are automatically relieved of tension and held securely in the enclosure thanks to the 'integrated' strain relief of the cable entries. The fact that the systems are fully separable is particularly advantageous for maintenance or retrofitting, as there is no need to disconnect the cables.

Complete **flange plates** for Rittal AX enclosures, AE enclosures, KX/KL terminal boxes or BG bus enclosures, as well as prepared **module plates** with standard cut-outs for mounting icotek cable entry systems in the enclosure base, are also available in many variants.

icotek offers a wide range of useful **accessories** for enclosures for the installation of cable entry systems and cable glands as well as for cable management.

The patented KDR base entry systems

KDR-ESR-VX25

KDRS-ESR-VX25

- Routing of pre-terminated cables of up to 65 mm in diameter (KEL-JUMBO)
- Optional with EMC cable assembly KDR-EMC-PFM
- Fast and tool-free mounting of KEL-U cable entry frames
- Routing of pre-terminated cables of up to 35 mm in diameter (KEL-U 24)
- Straight cable routing into the cable duct



The custom made thread extension for cable glands and cable entry plates

- IP protection of the cable gland or cable entry plate used remains in place
- Indentation for wrench size for easy tightening of the screw connection
- Especially suitable for sandwich panels of all wall thicknesses
- Almost endless extension possible
- Different thread lengths can be flexibly combined with each other
- Larger lengths can be shortened at the notch between the threads, without damaging the threads
- Available in sizes M32, M50 and M63
Thread lengths: 35 mm, 60 mm or 120 mm
- Fits to all round icotek cable glands and cable entry plates M32, M50 and M63

Chapter content

6.1 Gland plates and module plates for enclosures



IP54

Rittal/Hoffman/Häwa
Enclosure gland plates
with slide frames for cable entry frames

KDR-ESR-VX25 / KDRS-ESR-VX25 /
KDR-ESR-TS8 / KDR-ESR-HW / KDR-ESR-HG2

258 – 267



IP54

Rittal
Enclosure gland plates
split, for cable entry frames

KDR 2-VX25 / KDR 2-TS8

268 – 269



IP54

Rittal/Lohmeier
Module plates
for cable entry components

MP

270 – 271



IP54

Rittal
Enclosure gland plates
for MP module plates

KDR-BMP-VX25 / KDR-BMP-TS8

272 – 275

6.2 Flange plates for enclosures



IP54 IP66

Rittal
Flange plates for enclosures
for cable entry components

FP-AX / FP-AE / FP-KX / FP-KL

276 – 283

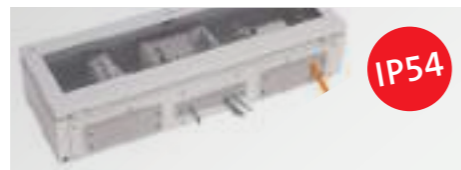

IP54

Fibox
Flange plates for enclosures
for cable entry components

FP-BG / FP-FL21

284 – 285

6.3 Blank plates



IP65

Blank plates

BPK / BPK-RF / BPM / BPK-SNAP

286 – 288

6.4 Accessories



NEW

Thread extension
for cable glands and cable entry plates
M32, M50, M63

TE-M

290 – 291



Hexagonal Locknuts
M16 – M85

KGM / GM / GMT

292



Supports
for top hat DIN rails and bus bars

MF

293



NEW

Sealing bead
for enclosure base plates

294



Sealing tape
for enclosure base plates

294



Drainage Device

295

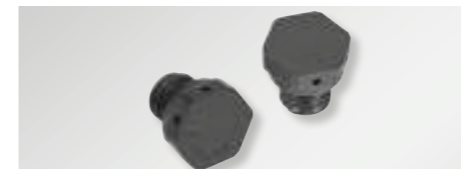

Pressure compensation element
with metric thread

PCE M12 x 1,5

295



Cable clamp
for C-rail mount

CCL

168 – 169



Rittal / Hoffman / Others
Universal brush strip
for enclosures

KDR-BES-U

300 – 305

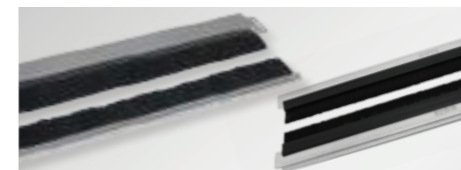

Rittal
Enclosure gland plates
with brush grommets

KDRS-BES-U / KDR-BES-TS8

306 – 307



Rittal
Split flange plates
with brush strips

FP-AX-BES-U

310 – 311

KDR-ESR-VX25

Rittal enclosure gland plate with slide frames

IP54

The KDR-ESR is a one-piece plate to be assembled on enclosure bases. Slide frames for the KEL cable entry frames are already pre-assembled.

After installing all cables into the KEL frames, they are easily and quickly inserted into the slide frames and fixed. During maintenance, the KEL frames are removed without tools from the slide frames. Due to the combination KDR-ESR and KEL cable entry frames, a rating of IP54 is achieved (with correct selection of cable grommets). Slide frames which are no longer required are closed with BPK-SNAP blank plates.

Advantages & benefits

- Easy assembly and removal
- Prepared for the assembly of KDR-EMV-PFM
- Ideal for maintenance and retrofitting
- Reserve can be scheduled
- Space-saving solution
- No additional sheet metal work required

Specifications

Material	Gland plate: Sheet steel, zinc-plated KDR-ESR Frame: Polyamide (PA)
Flame class	UL 94 V-0, self-extinguishing
IP rating	IP54, with gasket and correct selection of cable entry devices
Temperature	- 40°C to + 90°C (static)
Properties	Halogen free, silicone free

Compatible with

KEL(-U) 16 / 24 Cable entry frames	14 - 16
KEL-QUICK 16 / 24 Cable entry frames	96 - 97
KEL-JUMBO Cable entry frames	50
BPK-SNAP 16 / 24 Blank plates	288



Slide frames which are no longer required are closed with BPK-SNAP blank plates



Prepared for the assembly of KDR-EMV-PFM. The plates are fitted with threaded screw holes (M5), blocked with plugs. These can be easily removed if necessary. By using the KDR-EMV-PFM, there is no need to additionally install a DIN rail/bus bar above the cable entry, which would otherwise have to be attached in order to implement the EMC connection.

KDR-ESR-VX25

Rittal enclosure gland plate with slide frames

IP54



Type	Enclosure width	Total length gland plate	Sight size of base plate opening	No. of possible cable entries				Order No.
				JUMBO 1	JUMBO 2	KEL(-U) 16 ...	KEL(-U) 24 ...	
KDR-ESR-VX25-600	600 mm	488 mm	452 mm	-	-	-	2	44500
KDR-ESR-VX25-600	600 mm	488 mm	452 mm	-	1	-	1	44501
KDR-ESR-VX25-600	600 mm	488 mm	452 mm	1	-	2	-	44502
KDR-ESR-VX25-800	800 mm	688 mm	652 mm	-	-	1	3	44503
KDR-ESR-VX25-800	800 mm	688 mm	652 mm	1	-	1	2	44504
KDR-ESR-VX25-800	800 mm	688 mm	652 mm	-	1	-	2	44505
KDR-ESR-VX25-1000	1000 mm* with division bar	438 mm	402 mm	-	-	-	2	44506
KDR-ESR-VX25-1000	1000 mm* with division bar	438 mm	402 mm	1	-	-	1	44507
KDR-ESR-VX25-1000	1000 mm* with division bar	438 mm	402 mm	-	1	1	-	44508
KDR-ESR-VX25-1200	1200 mm*	538 mm	502 mm	-	-	-	3	44509
KDR-ESR-VX25-1200	1200 mm*	538 mm	502 mm	1	-	1	1	44510
KDR-ESR-VX25-1200	1200 mm*	538 mm	502 mm	-	1	-	1	44511

* if both fields of the enclosure are fitted, two complete gland plates are required.

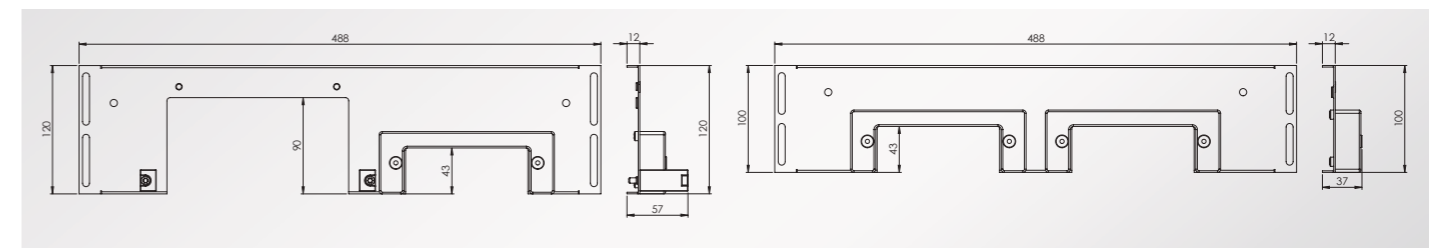

EMC cable assembly for KDR-ESR-VX25

Type	Order No.	Material	PU
KDR-EMC-PFM 16	39192	Steel, zinc plated	1
KDR-EMC-PFM 24	39191	Steel, zinc plated	1

Suitable EMC shield clamps can be found on pages 198, 199 (PFSZ, SKS, SS|SK, SS|SKZ).



KDRS-ESR-VX25

Rittal enclosure gland plate, narrow, with slide frames



IP54



The KDRS-ESR is a one-piece plate to be assembled on enclosure bases. Slide frames for the KEL cable entry frames are already pre-assembled.

After installing all cables into the KEL frames, they are easily and quickly inserted into the slide frames and fixed. During maintenance, the KEL frames are removed without tools from the slide frames. Due to the combination KDRS-ESR and KEL cable entry frames, a rating of IP54 is achieved (with correct selection of cable grommets). Slide frames which are no longer required, are closed with BPK-SNAP blank plates.

Advantages & benefits

- Easy assembly and removal
- The KDRS-ESR floor plate is very narrow. As a result, the inserted cables are inserted straight into the cable duct.
- Ideal for maintenance and retrofitting
- Reserve can be scheduled
- Space-saving solution
- No additional sheet metal work required

Specifications

Material	Gland plate: Sheet steel, zinc-plated KDR-ESR Frame: Polyamide (PA)
Flame class	UL 94 V-0, self-extinguishing
IP rating	IP54, with gasket and correct selection of cable entry devices
Temperature	-40°C to +90°C (static)
Properties	Halogen free, silicone free

Compatible with

KEL(-U) 16 / 24 Cable entry frames	14 - 16
KEL-QUICK 16 / 24 Cable entry frames	96 - 97
BPK-SNAP 16 / 24 Blank plates	288



Advantage KDRS: Straight cable routing into the cable duct due to the extremely narrow gland plate



i icotek can also produce enclosure gland plates for numerous other enclosure brands and in other sizes according to your wishes. Ask us at pm@icotek.com!



IP54



KDRS-ESR-VX25
Rittal enclosure gland plate, narrow, with slide frames

Type	Enclosure width	Total length gland plate	Sight size of base plate opening	No. of possible cable entries				Order No.
				JUMBO 1	JUMBO 2	KEL(-U) 16[...]	KEL(-U) 24[...]	
KDRS-ESR-VX25-600 (narrow) 75 mm	600 mm	488 mm	452 mm	–	–	–	2	44512
KDRS-ESR-VX25-800 (narrow) 75 mm	800 mm	688 mm	652 mm	–	–	–	3	44513
KDRS-ESR-VX25-1000 (narrow) 75 mm	1000 mm*	438 mm	402 mm	–	–	–	2	44514
KDRS-ESR-VX25-1200 (narrow) 75 mm	1200 mm*	538 mm	502 mm	–	–	–	3	44515

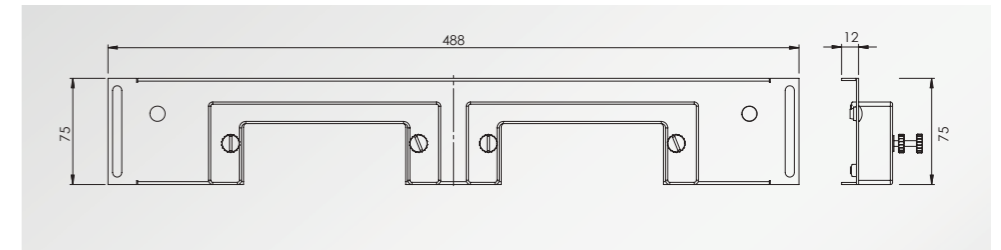

Sealing tape
Order No. 42999 (L: 1 m)
Order No. 42999.10000 (L: 10 m)

* if both fields of the enclosure are fitted, two complete gland plates are required.

KDR-ESR-TS8

Rittal TS8 enclosure gland plate with slide frames



The KDR-ESR is a one-piece plate to be assembled on enclosure bases. Slide frames for the KEL cable entry frames are already pre-assembled.

After installing all cables into the KEL frames, they are easily and quickly inserted into the slide frames and fixed. During maintenance, the KEL frames are removed without tools from the slide frames. Due to the combination KDR-ESR and KEL cable entry frames, a rating of IP54 is achieved (with correct selection of cable grommets). Slide frames which are no longer required are closed with BPK-SNAP blank plates.

Advantages & benefits

- Easy assembly and removal
- During assembly, almost the complete base of the enclosure can be used for installation of cables
- Even large connectors can be installed easily
- The gland plate KDR-ESR is designed for Rittal enclosures VX25 & TS 8. Other sizes can be supplied on request
- No additional sheet metal work required
- Retrofitting possible without disconnecting cables. Everything can be built around the cables

Specifications

Material	Gland plate: Sheet steel, zinc-plated KDR-ESR Frame: Polyamide (PA)
Flame class	UL 94 V-0, self-extinguishing
IP rating	IP54, with gasket and correct selection of cable entry devices
Temperature	- 40°C to + 90°C (static)
Properties	Halogen free, silicone free

Compatible with

KEL(-U) 16 / 24 Cable entry frames	14 - 16
KEL-QUICK 16 / 24 Cable entry frames	96 - 97
KEL-JUMBO Cable entry frames	50
BPK-SNAP 16 / 24 Blank plates	288



Sealing tape
Order No. 42999 (L: 1 m)
Order No. 42999.10000 (L: 10 m)

KDR-ESR-TS8

Rittal TS8 enclosure gland plate with slide frames



Type	Enclosure width	Total length gland plate	Sight size of base plate opening	No. of possible cable entries				Order No.
				JUMBO 1	JUMBO 2	KEL(-U) 16 ...	KEL(-U) 24 ...	
KDR-ESR for Rittal TS8								
KDR-ESR-TS8-600	600 mm	458 mm	435 mm	-	-	-	2	43079
KDR-ESR-TS8-600	600 mm	458 mm	435 mm	-	1	-	1	43070
KDR-ESR-TS8-600	600 mm	458 mm	435 mm	1	-	2	-	43071
KDR-ESR-TS8-800	800 mm	658 mm	635 mm	-	-	1	3	43080
KDR-ESR-TS8-800	800 mm	658 mm	635 mm	1	-	-	3	43072
KDR-ESR-TS8-800	800 mm	658 mm	635 mm	-	1	-	2	43073
KDR-ESR-TS8-1000	1000 mm without division bar	858 mm	835 mm	-	-	-	5	43081
KDR-ESR-TS8-1000	1000 mm without division bar	858 mm	835 mm	1	-	-	4	43074
KDR-ESR-TS8-1000	1000 mm without division bar	858 mm	835 mm	-	1	-	3	43075
KDR-ESR-TS8-1000	1000 mm* with division bar	420 mm	398 mm	-	-	-	2	43082
KDR-ESR-TS8-1000	1000 mm* with division bar	420 mm	398 mm	1	-	-	1	43076
KDR-ESR-TS8-1000	1000 mm* with division bar	420 mm	398 mm	-	1	-	1	43077
KDR-ESR-TS8-1200	1200 mm*	518 mm	495 mm	-	-	-	3	43083
KDR-ESR-TS8-1200	1200 mm*	518 mm	495 mm	1	-	-	2	43078
KDR-ESR-TS8-1200	1200 mm*	518 mm	495 mm	-	1	-	1	43084

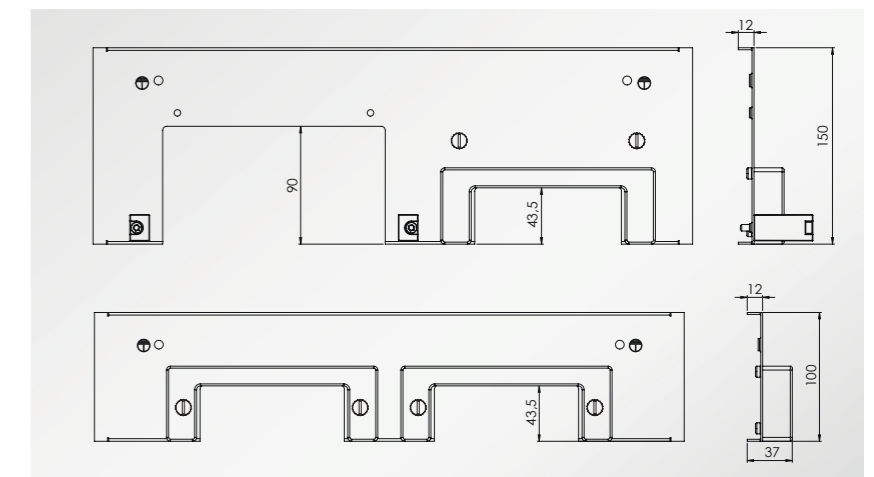

KDR-ESR-TS8 for Rittal TS 8

* in case both fields of the enclosure are equipped, 2 complete gland plates are necessary.

KDR-ESR-HW

Enclosure gland plate with slide frames for Häwa enclosures

IP54

The KDR-ESR HW is a one-piece plate to be assembled on enclosure bases. Slide frames for the KEL cable entry frames are already pre-assembled. After installing all cables into the KEL frames, they are easily and quickly inserted into the slide frames and fixed. Slide frames which are no longer required are closed with BPK-SNAP blank plates. The gland plate KDR-ESR HW is designed for Häwa enclosures series H395 and series H390.

Advantages & benefits

- Easy assembly and removal
- Even large connectors can be installed easily
- Retrofitting possible without disconnecting cables. Everything can be built around the cables
- Prepared for the assembly of KDR-EMV-PFM
- No additional sheet metal work required
- The gland plate KDR-ESR HW is designed for Häwa enclosures series H395 and series H390
- Other sizes are available on request

Specifications

Material	Gland plate: Sheet steel, zinc-plated KDR-ESR Frame: Polyamide (PA)
Flame class	UL 94 V-0, self-extinguishing
IP rating	IP54, with gasket and correct selection of cable entry devices
Temperature Properties	-40°C to + 90°C (static) Halogen free, silicone free

Compatible with

KEL(-U) 24 Cable entry frames	14 - 16
KEL-QUICK 24 Cable entry frames	96 - 97
KEL-JUMBO Cable entry frames	50
BPK-SNAP 24 Blank plates	288



Prepared for the assembly of KDR-EMV-PFM. The plates are fitted with threaded screw holes (M5), blocked with plugs. These can be easily removed if necessary. By using the KDR-EMV-PFM, there is no need to additionally install a DIN rail/bus bar above the cable entry, which would otherwise have to be attached in order to implement the EMC connection.



Slide frames which are no longer required are closed with BPK-SNAP blank plates

KDR-ESR-HW
Enclosure gland plate with slide frames for Häwa enclosures

IP54

Type	Enclosure width	Total length gland plate	Sight size of base plate opening	No. of possible cable entries				Order No.
				JUMBO 1	JUMBO 2	KEL(-U) 16 ...	KEL(-U) 24 ...	
KDR-ESR HW for Häwa enclosures series H395 and series H390								
KDR-ESR HW-600 + 1 blank plate	600 mm	427 mm	392 mm	-	-	-	2	44520
KDR-ESR HW-800 + 1 blank plate	800 mm	627 mm	592 mm	-	-	-	3	44521
KDR-ESR HW-800	1000 mm	627 mm	592 mm	1	-	-	2	44522
KDR-ESR HW-1000 + 1 blank plate	1000 mm	827 mm	792 mm	-	-	-	4	44523
KDR-ESR HW-1200 + 1 blank plate	1200 mm	1027 mm	992 mm	-	-	-	5	44524
KDR-ESR HW-1200	1200 mm	1027 mm	992 mm	1	-	-	4	44525
KDR-ESR HW-1200	1200 mm	1027 mm	992 mm	-	1	-	4	44526

icotek can also produce enclosure gland plates for numerous other enclosure brands and in other sizes according to your wishes. Ask us at pm@icotek.com!



KDR-ESR-HG2

Enclosure gland plate with slide frames for Hoffman PROLINE G2

IP54

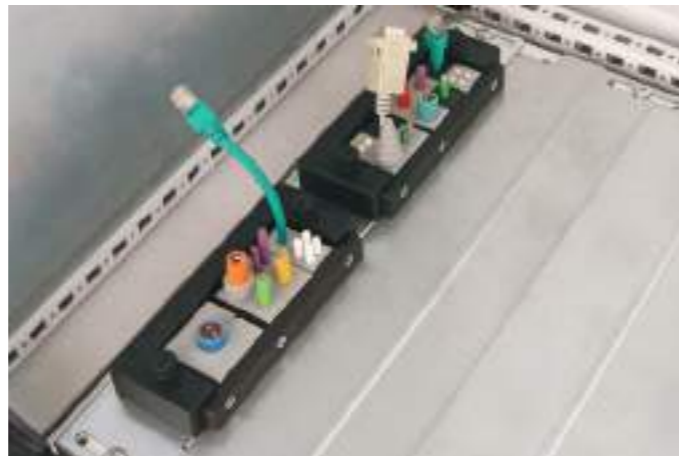

The KDR-ESR-HG2 is a one-piece plate to be assembled on enclosure bases. Slide frames for the KEL cable entry frames are already pre-assembled.

After installing all cables into the KEL frames, they are easily and quickly inserted into the slide frames and fixed. During maintenance, the KEL frames are removed without tools from the slide frames. Due to the combination KDR-ESR-HG2 and KEL cable entry frames, a rating of IP54 is achieved (with correct selection of cable grommets). Slide frames which are no longer required, are closed with BPK-SNAP blank plates.

Advantages & benefits

- Easy assembly and removal
- During assembly, almost the complete base of the enclosure can be used for installation of cables
- Even large connectors can be installed easily
- The gland plate KDR-ESR-HG2 is designed for Hoffman enclosures PROLINE G2. Other sizes can be supplied on request
- No additional sheet metal work required
- Retrofitting possible without disconnecting cables. Everything can be built around the cables

Specifications

Material	Gland plate: Sheet steel, zinc-plated KDR-ESR Frame: Polyamide (PA)
Flame class	UL 94 V-0, self-extinguishing
IP rating	IP54, with gasket and correct selection of cable entry devices
Temperature	-40°C to +90°C (static)
Properties	Halogen free, silicone free

Compatible with

KEL(-U) 16 / 24 Cable entry frames	14 - 16
KEL-QUICK 16 / 24 Cable entry frames	96 - 97
KEL-JUMBO Cable entry frames	50
BPK-SNAP 16 / 24 Blank plates	288



Sealing tape
Order No. 42999 (L: 1 m)
Order No. 42999.10000 (L: 10 m)

KDR-ESR-HG2

Enclosure gland plate with slide frames for Hoffman PROLINE G2

IP54



Type	Enclosure width	Total length gland plate	Sight size of base plate opening	No. of possible cable entries			Order No.
				JUMBO 2	KEL(-U) 16 ...	KEL(-U) 24 ...	
KDR-ESR-HG2-600	600 mm / 1200 mm*	432 mm	368 mm	1	1	-	43250
KDR-ESR-HG2-600	600 mm / 1200 mm*	432 mm	368 mm	-	-	2	43251
KDR-ESR-HG2-800	800 mm	632 mm	568 mm	1	-	2	43252
KDR-ESR-HG2-800	800 mm	632 mm	568 mm	-	-	3	43253
KDR-ESR-HG2-1000	1000 mm	832 mm	768 mm	1	-	3	43254
KDR-ESR-HG2-1000	1000 mm	832 mm	768 mm	-	-	4	43255

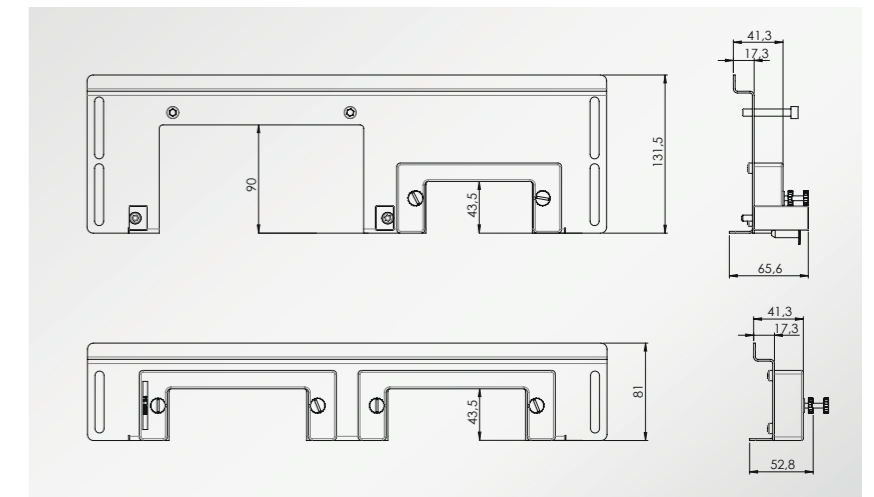

* in case both fields of the enclosure are equipped, 2 complete gland plates are necessary.

KDR 2-VX25 | KDR 2-TS8

Split Rittal enclosure gland plates

KDR 2-VX25 | KDR 2-TS8

Split Rittal enclosure gland plates

IP54



Split, 2-part gland plates KDR 2 with pre-cut holes for KEL and KEL-JUMBO cable entry systems.

KDR 2 Assembly

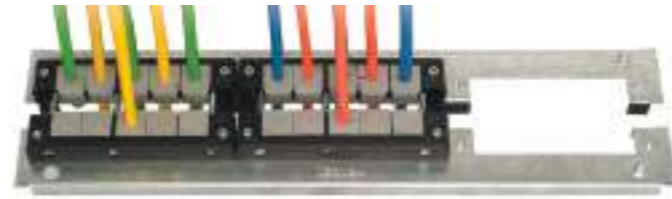

When the cable entry frames are assembled, the KDR gland plates move together for a tight, secure hold of the cable entry systems.

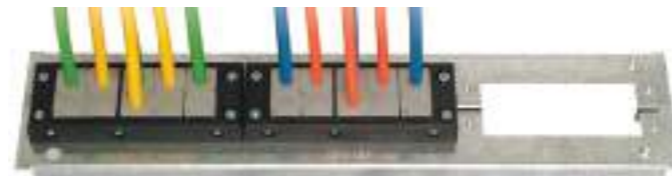

The frame parts with grommets have to be built up before final assembly, i.e. before screwing the system together. Screwing of the cable entry frames tightens both parts of the split gland plate.



Integrated screw holes provide quick and easy installation of KEL frames.

Advantages & benefits

- During assembly, almost the complete base of the enclosure can be used for installation of cables
- Even large connectors can be installed easily
- The gland plate KDR 2 is designed for Rittal enclosures TS 8 & VX25. Other sizes can be supplied on request
- Retrofitting is possible without disconnecting of cables. All can be installed around the cables.
- No additional sheet metal work required
- Cut-outs, which are no longer required, are covered with metal blank plates Type BPM

Specifications

Material Sheet steel, zinc-plated

Compatible with

KEL 24 Cable entry frames	23
KEL-JUMBO Cable entry frames	50
BPM Blank plates metal	288

Type	Enclosure width	Total length gland plate	Sight size of base plate opening	No. of possible cable entries			Order No.
				JUMBO 1	JUMBO 2	KEL 24 ...	
KDR 2 for Rittal VX25							
KDR 2-VX25-600	600 mm	488 mm	452 mm	-	-	3	44400
KDR 2-VX25-600	600 mm	488 mm	452 mm	1	-	2	44401
KDR 2-VX25-600	600 mm	488 mm	452 mm	-	1	1	44402
KDR 2-VX25-800	800 mm	688 mm	652 mm	-	-	4	44403
KDR 2-VX25-800	800 mm	688 mm	652 mm	1	-	3	44404
KDR 2-VX25-800	800 mm	688 mm	652 mm	-	1	2	44405
KDR 2-VX25-1000	1000 mm* with division bar	438 mm	402 mm	-	-	2	44406
KDR 2-VX25-1000	1000 mm* with division bar	438 mm	402 mm	1	-	1	44407
KDR 2-VX25-1000	1000 mm* with division bar	438 mm	402 mm	-	1	1	44408
KDR 2-VX25-1200	1200 mm*	538 mm	502 mm	-	-	3	44409
KDR 2-VX25-1200	1200 mm*	538 mm	502 mm	1	-	2	44410
KDR 2-VX25-1200	1200 mm*	538 mm	502 mm	-	1	1	44411
KDR 2 for Rittal TS8							
KDR 2-TS8-600	600 mm	458 mm	435 mm	-	-	3	42924
KDR 2-TS8-600	600 mm	458 mm	435 mm	1	-	2	42953
KDR 2-TS8-600	600 mm	458 mm	435 mm	-	1	1	42941
KDR 2-TS8-800	800 mm	658 mm	635 mm	-	-	4	42922
KDR 2-TS8-800	800 mm	658 mm	635 mm	1	-	3	42954
KDR 2-TS8-800	800 mm	658 mm	635 mm	-	1	2	42945
KDR 2-TS8-1000	1000 mm without division bar	858 mm	835 mm	-	-	5	42923
KDR 2-TS8-1000	1000 mm without division bar	858 mm	835 mm	1	-	4	42955
KDR 2-TS8-1000	1000 mm without division bar	858 mm	835 mm	-	1	3	42952
KDR 2-TS8-1000	1000 mm* with division bar	420 mm	398 mm	-	-	2	42958
KDR 2-TS8-1000	1000 mm* with division bar	420 mm	398 mm	1	-	1	42957
KDR 2-TS8-1000	1000 mm* with division bar	420 mm	398 mm	-	1	1	42959
KDR 2-TS8-1200	1200 mm*	518 mm	495 mm	-	-	3	42920
KDR 2-TS8-1200	1200 mm*	518 mm	495 mm	1	-	2	42956
KDR 2-TS8-1200	1200 mm*	518 mm	495 mm	-	1	1	42943

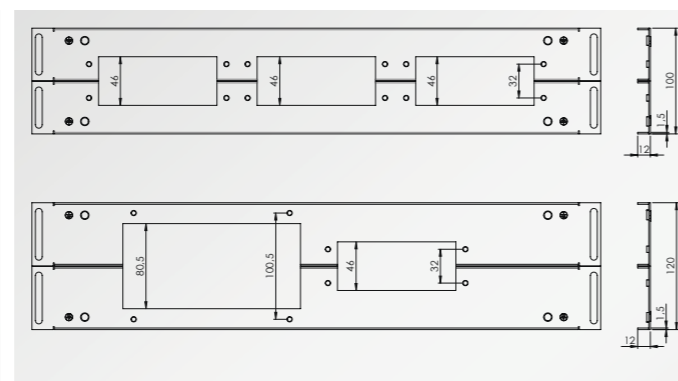
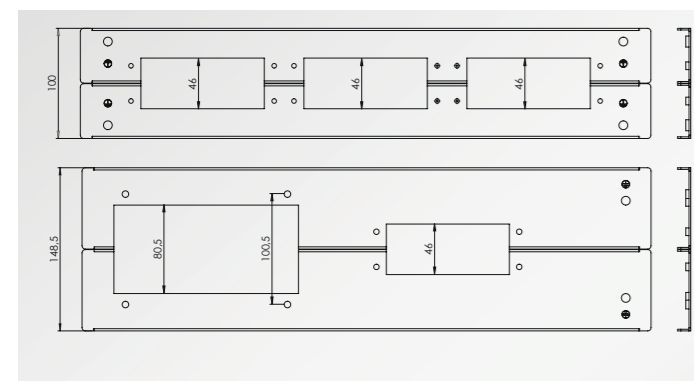

KDR 2-TS8 for Rittal TS 8

KDR 2-VX25 for Rittal VX25



* in case both fields of the enclosure are equipped, 2 complete split gland plates are necessary.

MP
Module plates



The module plates have cut-outs for fixing the KEL range cable entry systems KEL-FA 24, KEL 24, KEL-U 24, KEL-QUICK 24, KEL-JUMBO, KEL-DPF, KEL-JUMBO flex and KEL-ULTRA flex.

The module plates can be installed on:

- Separation walls by Rittal
- closed enclosure bases and roofs (various manufacturers)
- Bases of Lohmeier enclosures
- Bases of Rittal enclosures via KDR-BMP gland plates

The module blank plate without cut-outs (Order No. 43882) is designed for closing unused cut-outs. This module plate can even be used for self-made cut-outs.

Module plates are supplied with a gasket.

Specifications

Material	Sheet steel, zinc-plated
	Aluminium (Order No. 43883, 43899)
Dimension	338 × 168 × 2 mm

Compatible with

KEL-FA 24 Cable entry frames	19
KEL 24 Cable entry frames	23
KEL-U 24 Cable entry frames	15
KEL-QUICK 24 Cable entry frames	96
KEL-SNAP snap frames	46 - 49
KEL-JUMBO Cable entry frames	45
KEL-DPF Cable entry grommets	160 - 161
KEL-JUMBO flex Cable entry ins.	163
KEL-ULTRA flex Cable entry ins.	162
Blank plates	286 - 288

MP Applications



Cable routing via module plates in the base of a Rittal TS8 enclosure. Mounting with icotek gland plate KDR BMP.



Cable routing through the divider panel of a Rittal TS8 baying enclosure system via module plates.



Routing of several cables with and without connectors through a closed enclosure roof via module plates. Cut-out size 314 × 144 mm.



Routing of a rigid supply line through a closed enclosure roof via module plates. Cut-out size 314 × 144 mm.

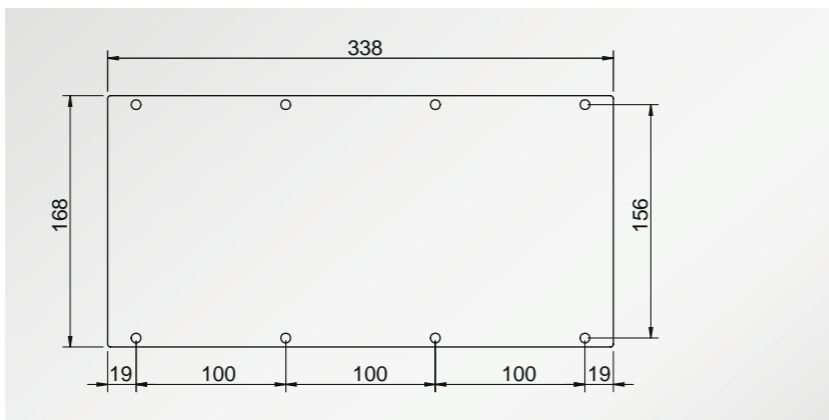

MP
Module plates



Description	Type	Order No.	Compatible with
	MP 0	43882	Module plate, blank
	MP 1	43891	3× KEL(-FA/-U/-QUICK) 24 x
	MP 2	43890	4× KEL(-FA/-U/-QUICK) 24 x
	MP 3	43886	1× KEL-JUMBO 1 1× KEL-JUMBO 2
	MP 4	43888	2× KEL-JUMBO 1
	MP 5	43887	2× KEL(-FA/-U/-QUICK) 24 x 1× KEL-JUMBO 1
	MP 6	43883	5× cut-out M50 for KEL-DPF or KEL-DPZ
	MP 7	43889	Cut-out 3× KEL-JUMBO flex
	MP 8	43894	Cut-out 2× KEL-ULTRA flex
	MP 10	43896	2× KEL(-FA/-U/-QUICK) 24 x 1× cut-out M63 for KEL-DPF or KEL-DPZ
	MP 11	43899	5× cut-out M63 for KEL-DPF or KEL-DPZ



KDR-BMP for VX25
Enclosure gland plates
for module plates



The KDR-BMP gland plates are ideally suited for Rittal VX25 enclosures and can be used instead of the 3 piece standard gland plates. The KDR-BMP gland plates are fixed by screwing.

On KDR-BMP gland plates, our MP Module Plates MP0-MP11 can be easily mounted and used for installation of cable entry components.

Note: The division bar can be removed in Rittal enclosures.

Advantages & benefits

- Very simple mounting
- No sheet metal work required

Specifications

Material Sheet steel, zinc-plated
IP rating IP54, with gasket and correct selection of cable entry devices

Compatible with

MP Module plates 270 - 271

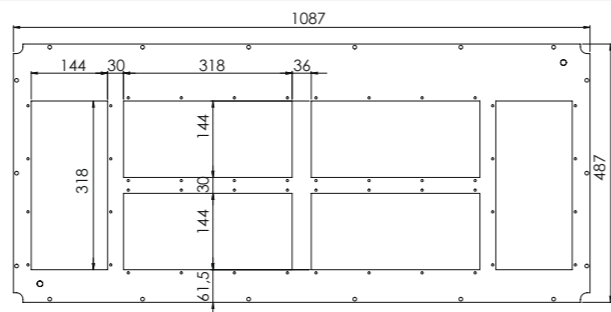
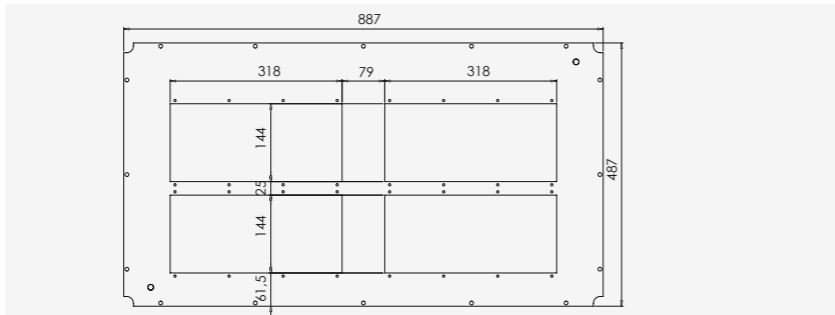
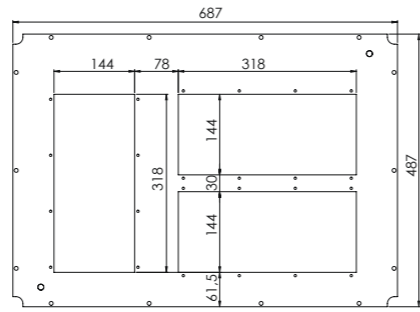
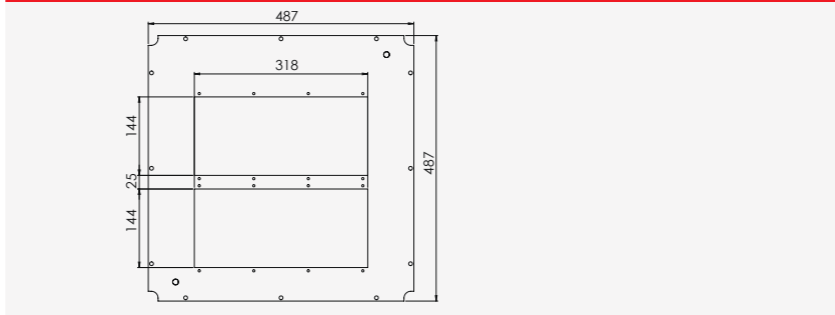

KDR-BMP for VX25
Enclosure gland plates
for module plates



Type	Enclosure type	Enclosure width	Enclosure depth	No. of cut-outs for module plates	Order No.
KDR-BMP 600/600	VX25	600 mm	600 mm	2	43334
KDR-BMP 800/600	VX25	800 mm	600 mm	3	43340
KDR-BMP 1000/600	VX25	1000 mm without division bar	600 mm	4	43346
KDR-BMP 1200/600	VX25	1200 mm without division bar	600 mm	6	43352

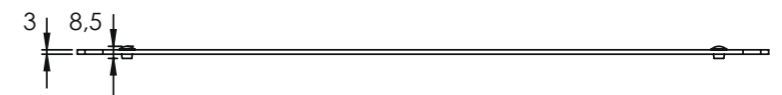

KDR-BMP for TS8
Enclosure gland plates
for module plates



The KDR-BMP gland plates are ideally suited for Rittal TS enclosures and can be used instead of the 3 piece standard gland plates.
Rittal standard mounting clips are used for fixing the plate.

On KDR-BMP gland plates, our MP Module Plates MP0-MP8 can be easily mounted and used for installation of cable entry components.

Advantages & benefits

- Very simple mounting
- No sheet metal work required

Specifications

Material Sheet steel, zinc-plated
IP rating IP54, with gasket and correct selection of cable entry devices

Compatible with

MP Module plates 270 - 271

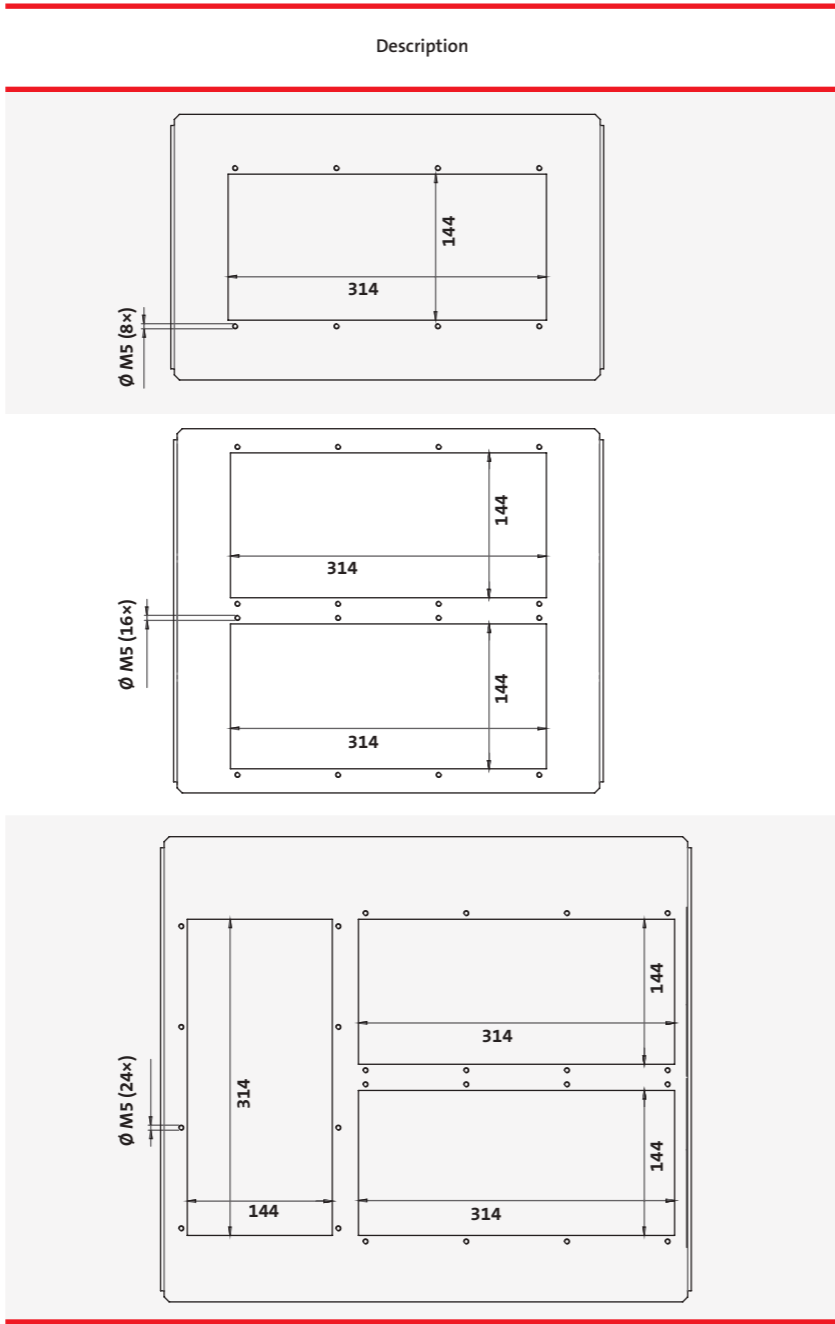

KDR-BMP for TS8
Enclosure gland plates
for module plates



Type	Enclosure type	Enclosure width	Enclosure depth	No. of cut-outs for module plates	Order No.
KDR-BMP 600/400	TS 8	600 mm	400 mm	1	43300
KDR-BMP 600/500	TS 8	600 mm	500 mm	2	43302
KDR-BMP 600/600	TS 8	600 mm	600 mm	2	43304
KDR-BMP 800/400	TS 8	800 mm	400 mm	1	43306
KDR-BMP 800/500	TS 8	800 mm	500 mm	3	43308
KDR-BMP 800/600	TS 8	800 mm	600 mm	3	43310
KDR-BMP 1000/400	TS 8	1000 mm with division bar	400 mm	1	43312
KDR-BMP 1000/500	TS 8	1000 mm with division bar	500 mm	2	43314
KDR-BMP 1000/600	TS 8	1000 mm with division bar	600 mm	2	43316
KDR-BMP 1200/400	TS 8	1200 mm with division bar	400 mm	1	43318
KDR-BMP 1200/500	TS 8	1200 mm with division bar	500 mm	2 × 3	43320
KDR-BMP 1200/600 for left section	TS 8	1200 mm with division bar	600 mm	3	43322
KDR-BMP 1200/600 for right section	TS 8	1200 mm with division bar	600 mm	3	43324



FP-AX
Flange plates
for compact enclosures



We supply complete flange plates FP with 112 x 36 mm cut-outs for compact enclosures of the AX series. The cut-outs, as well as the drilling template, conform to the standard cut-outs for 24-pole industrial connectors.

All flange plates are RAL 7035 powder-coated. Please use the gaskets of the standard plates. Enclosures are supplied with gaskets and screws.

We recommend fastening the cable entry systems with a torque of 1.5 - 2.0 Nm.

Advantages & benefits

- No expensive extra sheet metal work is required
- High cable density is achieved by using KEL-FA, KEL, KEL-U, KEL-QUICK, KEL-DPU, KEL-DPZ or KEL-DP
- Reduce labour costs by using cable entry systems compared to the assembly of conventional cable glands

Specifications

Material Sheet steel, powder coated

Compatible with

KEL-FA Cable entry frames	18 - 21
KEL Cable entry frames	22 - 31
KEL-U Cable entry frames	14 - 16
KEL-QUICK Cable entry frames	96 - 97
KEL-SNAP Mounting frames	46 - 49
KEL-QTA 24 Cable entry frames	104
KEL-DPU 24 Cable entry plates	126 - 129
KEL-DPZ 24 Cable entry plates	130 - 137
KEL-DP 24 Cable entry plates	142 - 147
KEL-BES	298
KEL-BES-S	299
Blank plates	288



icotek also offers enclosure gland plates with brush strips, see pages 310 - 311. Contact us at pm@icotek.com

Description	

FP-AX
Flange plates
for compact enclosures



Type	Order No. RAL 7035	Compatible with: (Product Group 1)	Compatible with: (Product Group 2)	Size FP	Compatible with
FP-AX 256 149 with 1 cut-out 36 x 112 mm horizontal	43901	KEL 24 KEL-U 24 KEL-FA 24 KEL-QUICK 24 KEL-QTA 24 KEL-BES 24 KEL-BES-S 24	KEL-DPZ 24 KEL-DPU 24 KEL-DP 24	1	AX 1033.000 AX 1034.000
FP-AX 256 149 with 2 cut-outs 36 x 112 mm horizontal	43902	KEL 24 KEL-U 24 KEL-FA 24 KEL-QUICK 24 KEL-QTA 24 KEL-BES 24 KEL-BES-S 24	KEL-DPZ 24 KEL-DPU 24 KEL-DP 24	1	AX 1033.000 AX 1034.000
FP-AX AE 339 149 with 2 cut-outs 36 x 112 mm	43840	KEL 24 KEL-U 24 KEL-FA 24 KEL-QUICK 24 KEL-SNAP 24 KEL-QTA 24 KEL-BES 24 KEL-BES-S 24	KEL-DPZ 24 KEL-DPU 24 KEL-DP 24	2	AX 1031.000 AX 1380.000 AX 1038.000 AX 1077.000 AX 1100.000 AX 1045.000
FP-AX AE 339 149 with 4 cut-outs 36 x 112 mm	43846	KEL 24 KEL-U 24 KEL-FA 24 KEL-QUICK 24 KEL-QTA 24 KEL-BES 24 KEL-BES-S 24	KEL-DPZ 24 KEL-DPU 24 KEL-DP 24	2	AX 1031.000 AX 1380.000 AX 1038.000 AX 1077.000 AX 1100.000 AX 1045.000
FP-AX 447 149 with 2 cut-outs 36 x 112 mm horizontal	43903	KEL 24 KEL-U 24 KEL-FA 24 KEL-QUICK 24 KEL-QTA 24 KEL-BES 24 KEL-BES-S 24	KEL-DPZ 24 KEL-DPU 24 KEL-DP 24	3	AX 1050.000 AX 1057.000
FP-AX 447 149 with 4 cut-outs 36 x 112 mm horizontal	43904	KEL 24 KEL-U 24 KEL-QUICK 24 KEL-QTA 24 KEL-BES 24 KEL-BES-S 24	KEL-DPZ 24 KEL-DPU 24 KEL-DP 24	3	AX 1050.000 AX 1057.000
FP-AX AE 534 149 with 4 cut-outs 36 x 86 mm	43871	KEL 16 KEL-U 16 KEL-FA 16 KEL-QUICK 16 KEL-SNAP 16 KEL-BES 16 KEL-BES-S 16	KEL-DPZ 16 KEL-DP 16	4	AX 1039.000 AX 1060.000 AX 1054.000 AX 1076.000 AX 1058.000 AX 1090.000
FP-AX AE 534 149 with 3 cut-outs 36 x 112 mm	43842	KEL 24 KEL-U 24 KEL-FA 24 KEL-QUICK 24 KEL-SNAP 24 KEL-QTA 24 KEL-BES 24 KEL-BES-S 24	KEL-DPZ 24 KEL-DPU 24 KEL-DP 24	4	AX 1039.000 AX 1060.000 AX 1054.000 AX 1076.000 AX 1058.000 AX 1090.000

FP-AX
Flange plates
for compact enclosures



We supply complete flange plates FP with 112 x 36 mm cut-outs for compact enclosures of the AX series. The cut-outs, as well as the drilling template, conform to the standard cut-outs for 24-pole industrial connectors.

All flange plates are RAL 7035 powder-coated. Please use the gaskets of the standard plates. Enclosures are supplied with gaskets and screws.

We recommend fastening the cable entry systems with a torque of 1.5 - 2.0 Nm.

Advantages & benefits

- No expensive extra sheet metal work is required
- High cable density is achieved by using KEL-FA, KEL, KEL-U, KEL-QUICK, KEL-DPU, KEL-DPZ or KEL-DP
- Reduce labour costs by using cable entry systems compared to the assembly of conventional cable glands

Specifications

Material Sheet steel, powder coated

Compatible with

KEL-FA Cable entry frames	18 - 21
KEL Cable entry frames	22 - 31
KEL-U Cable entry frames	14 - 16
KEL-QUICK Cable entry frames	96 - 97
KEL-SNAP Mounting frames	46 - 49
KEL-QTA 24 Cable entry frames	104
KEL-DPU 24 Cable entry plates	126 - 129
KEL-DPZ 24 Cable entry plates	130 - 137
KEL-DP 24 Cable entry plates	142 - 147
KEL-BES	298
KEL-BES-S	299
Blank plates	288



icotek also offers enclosure gland plates with brush strips, see pages 310 - 311. Contact us at pm@icotek.com

Description	
	FP-AX AE 534 149 with 6 cut-outs 36 x 112 mm
	FP-AX 301 221 with 3 cut-outs 36 x 112 mm horizontal, 3 rows
	FP-AX 301 221 with 4 cut-outs 36 x 112 mm vertical, 1 row
	FP-AX 401 221 with 6 cut-outs 36 x 112 mm horizontal, 3 rows
	FP-AX 401 221 with 5 cut-outs 36 x 112 mm vertical, 1 row
	FP-AX 436 221 with 6 cut-outs 36 x 112 mm horizontal, 3 rows
	FP-AX 436 221 with 6 cut-outs 36 x 112 mm vertical, 1 row

FP-AX
Flange plates
for compact enclosures



Type	Order No. RAL 7035	Compatible with: (Product Group 1)	Compatible with: (Product Group 2)	Size FP	Compatible with
FP-AX AE 534 149 with 6 cut-outs 36 x 112 mm	43848	KEL 24 KEL-U 24 KEL-FA 24 KEL-QUICK 24 KEL-QTA 24 KEL-BES 24 KEL-BES-S 24	KEL-DPZ 24 KEL-DPU 24 KEL-DP 24	4	AX 1039.000 AX 1060.000 AX 1054.000 AX 1076.000 AX 1058.000 AX 1090.000
FP-AX 301 221 with 3 cut-outs 36 x 112 mm horizontal, 3 rows	43905	KEL 24 KEL-U 24 KEL-FA 24 KEL-QUICK 24 KEL-SNAP 24 KEL-QTA 24 KEL-BES 24 KEL-BES-S 24	KEL-DPZ 24 KEL-DPU 24 KEL-DP 24	5	AX 1338.000 AX 1037.000 AX 1073.000 AX 1055.000 AX 1180.000 AX 1280.000 AX 1181.000 AX 1281.000
FP-AX 301 221 with 4 cut-outs 36 x 112 mm vertical, 1 row	43906	KEL 24 KEL-U 24 KEL-FA 24 KEL-QUICK 24 KEL-SNAP 24 KEL-QTA 24 KEL-BES 24 KEL-BES-S 24	KEL-DPZ 24 KEL-DPU 24 KEL-DP 24	5	AX 1338.000 AX 1037.000 AX 1073.000 AX 1055.000 AX 1180.000 AX 1280.000 AX 1181.000 AX 1281.000
FP-AX 401 221 with 6 cut-outs 36 x 112 mm horizontal, 3 rows	43907	KEL 24 KEL-U 24 KEL-FA 24 KEL-QUICK 24 KEL-QTA 24 KEL-BES 24 KEL-BES-S 24	KEL-DPZ 24 KEL-DPU 24 KEL-DP 24	6	AX 1350.000 AX 1130.000 AX 1110.000 AX 1213.000 AX 1114.000 AX 1214.000 AX 1115.000
FP-AX 401 221 with 5 cut-outs 36 x 112 mm vertical, 1 row	43908	KEL 24 KEL-U 24 KEL-FA 24 KEL-QUICK 24 KEL-SNAP 24 KEL-QTA 24 KEL-BES 24 KEL-BES-S 24	KEL-DPZ 24 KEL-DPU 24 KEL-DP 24	6	AX 1350.000 AX 1130.000 AX 1110.000 AX 1213.000 AX 1114.000 AX 1214.000 AX 1115.000
FP-AX 436 221 with 6 cut-outs 36 x 112 mm horizontal, 3 rows	43909	KEL 24 KEL-U 24 KEL-FA 24 KEL-QUICK 24 KEL-QTA 24 KEL-BES 24 KEL-BES-S 24	KEL-DPZ 24 KEL-DPU 24 KEL-DP 24	7	AX 1339.000 AX 1360.000 AX 1376.000 AX 1260.000 AX 1116.000 AX 1059.000 AX 1091.000 AX 1261.000
FP-AX 436 221 with 6 cut-outs 36 x 112 mm vertical, 1 row	43910	KEL 24 KEL-U 24 KEL-FA 24 KEL-QUICK 24 KEL-SNAP 24 KEL-QTA 24 KEL-BES 24 KEL-BES-S 24	KEL-DPZ 24 KEL-DPU 24 KEL-DP 24	7	AX 1339.000 AX 1360.000 AX 1376.000 AX 1260.000 AX 1116.000 AX 1059.000 AX 1091.000 AX 1261.000

FP-KX/KL
Flange plates for terminal boxes



The FP flange plates type KX/KL, designed to fit the Rittal KX/KL series terminal boxes, are installed in combination with a cable entry system for either pre-terminated or standard cables. FP flange plates are pre-cut, pre-drilled and painted for easy and quick installation of icotek cable routing products.

We recommend fastening the cable entry systems with a torque of 1.5 – 2.0 Nm.

Specifications

Material Sheet steel, powder coated

Compatible with

KEL-FA Cable entry frames	18 - 21
KEL Cable entry frames	22 - 31
KEL-U Cable entry frames	14 - 16
KEL-QUICK Cable entry frames	96 - 97
KEL-SNAP Mounting frames	46 - 49
KEL-QTA Cable entry frames	104
KEL-DPU Cable entry plates	126 - 129
KEL-DPZ Cable entry plates	130 - 137
KEL-DP Cable entry plates	142 - 147
KEL-BES	298
KEL-BES-S	299
Blank plates	288

Description



IP65 cable entry plate for Rittal KX and KL:
KEL-DPZ-KX/KL - page 137

FP-KX/KL
Flange plates for terminal boxes



Type	Order No. RAL 7035	Flange plates compatible with	Size FP	Compatible with
FP-KX/KL 221x90 10 with 1 cut-out 36 x 65 mm	43853	KEL 10 KEL-U 10 KEL-FA 10 KEL-QUICK 10 KEL-SNAP 10 KEL-SNAP-S 10 KEL-DPZ 10 KEL-DP 10 KEL-BES(-S) 10	2	Terminal boxes Type KL KX 1536.000 KX 1537.000 KX 1531.000 KX 1538.000 KX 1532.000 KX 1539.000 KX 1533.000 KX 1540.000 KX 1535.000 KX 1541.000
FP-KX/KL 221x90 16 with 1 cut-out 36 x 86 mm	43855	KEL 16 KEL-U 16 KEL-FA 16 KEL-QUICK 16 KEL-SNAP 16 KEL-SNAP-S 16 KEL-DPZ 16 KEL-DP 16 KEL-BES(-S) 16	2	Terminal boxes Type KL KX 1536.000 KX 1537.000 KX 1531.000 KX 1538.000 KX 1532.000 KX 1539.000 KX 1533.000 KX 1540.000 KX 1535.000 KX 1541.000
FP-KX/KL 221x90 24 with 1 cut-out 36 x 112 mm	43834	KEL 24 KEL-U 24 KEL-FA 24 KEL-QUICK 24 KEL-SNAP 24 KEL-QTA 24 KEL-DPZ 24 KEL-DPU 24 KEL-DP 24 KEL-BES(-S) 24	2	Terminal boxes Type KL KX 1536.000 KX 1537.000 KX 1531.000 KX 1538.000 KX 1532.000 KX 1539.000 KX 1533.000 KX 1540.000 KX 1535.000 KX 1541.000
FP-KX/KL 221x90 A with 3 cut-outs	43852	KEL-B KEL-U-B KEL-QUICK-B KEL-SNAP-B KEL-DPZ-B KEL-DPZ 40 KEL-DPF 40	2	Terminal boxes Type KL KX 1536.000 KX 1537.000 KX 1531.000 KX 1538.000 KX 1532.000 KX 1539.000 KX 1533.000 KX 1540.000 KX 1535.000 KX 1541.000
FP-KX/KL 221x90 B with 3 cut-outs 46 x 46 mm	43854	Use with: 2x KEL-SNAP-B and 1x KEL-DPZ-B	2	Terminal boxes Type KL KX 1536.000 KX 1537.000 KX 1531.000 KX 1538.000 KX 1532.000 KX 1539.000 KX 1533.000 KX 1540.000 KX 1535.000 KX 1541.000
FP-KX/KL 221x90 C with 3 cut-outs 46 x 46 mm	43856	KEL-B KEL-U-B KEL-QUICK-B KEL-DPZ-B	2	Terminal boxes Type KL KX 1536.000 KX 1537.000 KX 1531.000 KX 1538.000 KX 1532.000 KX 1539.000 KX 1533.000 KX 1540.000 KX 1535.000 KX 1541.000

FP-AE
Flange plates
for compact enclosures



We supply complete flange plates FP with 112 x 36 mm cut-outs for compact enclosures of the AE series. The cut-outs, as well as the drilling template, conform to the standard cut-outs for 24-pole industrial connectors.

All flange plates are RAL 7035 powder-coated. Please use the gaskets of the standard plates. Enclosures are supplied with gaskets and screws.

We recommend fastening the cable entry systems with a torque of 1.5 - 2.0 Nm.

Advantages & benefits

- No expensive extra sheet metal work is required
- High cable density is achieved by using KEL-FA, KEL, KEL-U, KEL-QUICK, KEL-DPU, KEL-DPZ or KEL-DP
- Reduce labour costs by using cable entry systems compared to the assembly of conventional cable glands

Specifications

Material Sheet steel, powder coated

Compatible with

KEL-FA Cable entry frames	18 - 21
KEL Cable entry frames	22 - 31
KEL-U Cable entry frames	14 - 16
KEL-QUICK Cable entry frames	96 - 97
KEL-SNAP Mounting frames	46 - 49
KEL-QTA Cable entry frames	104
KEL-DPU Cable entry plates	126 - 129
KEL-DPZ Cable entry plates	130 - 137
KEL-DP Cable entry plates	142 - 147
KEL-BES	298
KEL-BES-S	299
Blank plates	288

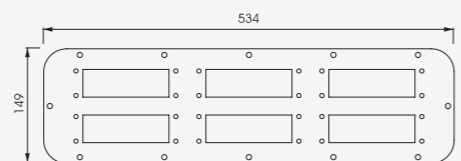
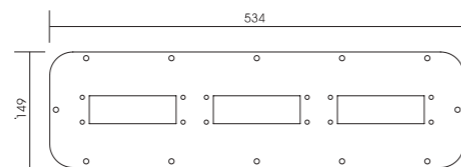
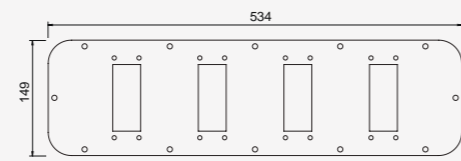
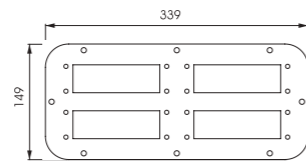
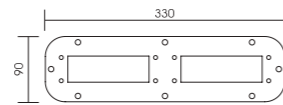
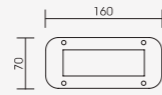

FP-AE
Flange plates
for compact enclosures



Type	Order No. RAL 7035	Compatible with: (Product Group 1)	Compatible with: (Product Group 2)	Size FP	Compatible with
FP-AE 160 70 with 1 cut-out 36 x 112 mm	43836	KEL-QTA 24	KEL-DP 24	1	AE 1032 AE 1035
FP-AE-24 330 90 with 2 cut-outs 36 x 112 mm	43838	KEL 24 KEL-U 24 KEL-QUICK 24 KEL-QTA 24 KEL-BES 24 KEL-BES-S 24	KEL-DPZ 24 KEL-DPU 24 KEL-DP 24	3	AE 1030 AE 1031 AE 1038 AE 1380
FP-AE-16 330 90 with 2 cut-outs 36 x 86 mm	43861	KEL 16 KEL-U 16 KEL-QUICK 16 KEL-BES 16 KEL-BES-S 16	KEL-DPZ 16 KEL-DP 16	3	
FP-AX AE 339 149 with 2 cut-outs 36 x 112 mm	43840	KEL 24 KEL-U 24 KEL-QUICK 24 KEL-SNAP 24 KEL-QTA 24 KEL-BES 24 KEL-BES-S 24	KEL-DPZ 24 KEL-DPU 24 KEL-DP 24	4	AE 1037 AE 1045 AE 1050 AE 1057 AE 1100 AE 1110 AE 1114 AE 1130 AE 1213 AE 1338 AE 1350
FP-AX AE 339 149 with 4 cut-outs 36 x 112 mm	43846	KEL 24 KEL-U 24 KEL-QUICK 24 KEL-QTA 24 KEL-BES 24 KEL-BES-S 24	KEL-DPZ 24 KEL-DPU 24 KEL-DP 24	4	TP 6710 TP 6712 TP 6714 TP 6716
FP-AX AE 534 149 with 4 cut-outs 36 x 86 mm	43871	KEL 16 KEL-U 16 KEL-QUICK 16 KEL-SNAP 16 KEL-BES 16 KEL-BES-S 16	KEL-DPZ 16 KEL-DP 16	5	AE 1039 AE 1054 AE 1055 AE 1058 AE 1060 AE 1073 AE 1076 AE 1077 AE 1090 AE 1180 AE 1260 AE 1280 AE 1339 AE 1360 AE 1376 AE 1958 EL 1919 EL 1926
FP-AX AE 534 149 with 3 cut-outs 36 x 112 mm	43842	KEL 24 KEL-U 24 KEL-QUICK 24 KEL-SNAP 24 KEL-QTA 24 KEL-BES 24 KEL-BES-S 24	KEL-DPZ 24 KEL-DPU 24 KEL-DP 24	5	
FP-AX AE 534 149 with 6 cut-outs 36 x 112 mm	43848	KEL 24 KEL-U 24 KEL-QUICK 24 KEL-QTA 24 KEL-BES 24 KEL-BES-S 24	KEL-DPZ 24 KEL-DPU 24 KEL-DP 24	5	IN 1076.290 TP 6711 TP 67113 TP 6715 TP 6717

FP-BG | FP-FL21
Flange plates for bus enclosures



The FP flange plates type BG, designed to fit the Rittal BG series enclosures, have up to 3 cut-outs that match the dimensions of the standard cut-outs for the 24-pole industrial connectors. These flange plates are installed in combination with a cable entry system for either pre-terminated cables (KEL-FA 24, KEL 24, KEL-U 24 or KEL-QUICK 24) or standard cables (KEL-DPZ 24, KEL-DPU 24 or KEL-DP 24).

We recommend fastening the cable entry systems with a torque of 1.5 – 2.0 Nm.

Specifications

Material Sheet steel, powder coated

Compatible with

KEL-FA 24 Cable entry frames	18 -21
KEL-U 24 Cable entry frames	22 - 31
KEL-QUICK 24 Cable entry frames	14 - 16
KEL-SNAP Mounting frames	96 - 97
KEL-QTA 24 Cable entry frames	46 - 49
KEL-DPU 24 Cable entry plates	104
KEL-DPZ 24 Cable entry plates	126 - 129
KEL-DP 24 Cable entry plates	130 - 137
Blank plates	142 - 147
	288

Description

FP-BG | FP-FL21
Flange plates for bus enclosures



Type	Order No. RAL 7035	Flange plates compatible with	Size FP.	Compatible with
FP-BG 355x92 with 2 cut-outs 36 x 112 mm	43866	KEL 24 KEL-U 24 KEL-FA 24 KEL-QUICK 24 KEL-SNAP 24 KEL-QTA 24 KEL-DPZ 24 KEL-DPU 24 KEL-DP 24 KEL-BES(-S) 24	-	BG 1558.510
FP-BG 555x92 with 3 cut-outs 36 x 112 mm	43865	KEL 24 KEL-U 24 KEL-FA 24 KEL-QUICK 24 KEL-SNAP 24 KEL-QTA 24 KEL-DPZ 24 KEL-DPU 24 KEL-DP 24 KEL-BES(-S) 24	6	BG 1050.900 BG 1559.510 IN 1510.280
FP-FL 21 with 1 cut-out 36 x 112 mm	43832	KEL 24 KEL-U 24 KEL-FA 24 KEL-QUICK 24 KEL-SNAP 24 KEL-QTA 24 KEL-DPZ 24 KEL-DPU 24 KEL-DP 24 KEL-BES(-S) 24	-	Fibox plates

BPK
Blank plates, plastic



BPK-RF

BPK

BPK Blank plates seal cut-outs for standard 10-pole / 16-pole / 24-pole industrial connectors with IP rating up to IP66.

Plastic blank plates are available in two different versions:

- Type BPK: Blank plates for screw connection
- Type BPK-RF A: Blank plates for snapping into metal sheet plates up to a thickness from 1.5 to 3 mm

Advantages & benefits

- Fast mounting of the blank plates BPK-RF range by snapping into the cut-out
- Integrated circular sealing (up to IP66)

Specifications

Material	Polypropylene (PP) Circular sealing: Elastomer
Flame class	UL 94 V-0
IP rating	BPK: IP66 BPK-RF A: IP54
Temperature Properties	-30°C to +140°C (static) Halogen free, silicone free

Compatible with

FP Flange plates 276 - 285

Type	Order No.	Blank plate for KEL cut-out	Dimensions	PU
BPK Blank plates for screw connection:				
BPK-B	42010	... -B	76 × 53 mm	10
BPK 10	42015	... 10	101 × 53 mm	10
BPK 16	42016	... 16	121 × 53 mm	10
BPK 24	42024	... 24 KEL-FG-ER A KEL-FG-A	148 × 53 mm	10
BPK Blank plates for snapping into cut-outs:				
BPK-B-RF A	42010.002	... -B	76 × 53 mm	10
BPK 10-RF A	42015.002	... 10	101 × 53 mm	10
BPK 16-RF A	42016.002	... 16	121 × 53 mm	10
BPK 24-RF A	42024.002	... 24 KEL-FG-ER A KEL-FG-A	148 × 53 mm	10
BPK-JFX	42620	KEL-JUMBO flex	88 × 88 mm	5



BPK-RF: Snap function, tool-free assembly



BPK: screwable

BPM
Blank plates, metal



Blank plates to close cut-outs for standard 6-pole/ 10-pole/16-pole/24-pole industrial connectors.

Blank plates are supplied with a gasket.

Specifications

Material	Steel, zinc-plated Width 2 mm
IP rating	IP66

Compatible with

KDR 2 Split gland plates	268 - 269
FP Flange plates	276 - 285
MP Module plates	270 - 271

Type	Order No.	Blank plate for KEL cut-out	Dimensions	PU
BPM-E2	42048	... -E2	73 × 39.5 mm	10
BPM-E3	42049	... -E3	98 × 39.5 mm	10
BPM-E4	42050	... -E4	120 × 39.5 mm	10
BPM-E5	42051	... -E5	147 × 39.5 mm	10
BPM-B BPM-B V2A	42013 41996	... -B	75 × 58 mm	10
BPM 6 BPM 6 V2A	42011 41991	Standard 6-pin industrial connectors	90 × 52 mm	10
BPM 10 BPM 10 V2A	42014 41992	... 10	99 × 58 mm	10
BPM-FG-B	42012	KEL-FG-B	80 × 58 mm	10
BPM 16 BPM 16 V2A	42025 41994	... 16	118 × 56 mm	10
BPM 16-E	42023	KEL 16-E	120 × 87 mm	1
BPM 16-MT	42026	KEL 16-MT	120 × 102 mm	1
BPM 16-2MT	42031	KEL 16-2MT	120 × 146 mm	1
BPM 24 BPM 24 V2A	42027 41995	... 24	145 × 56 mm	10
BPM 24-E	42029	KEL 24-E	143 × 83 mm	1
BPM 24-MT	42028	KEL 24-MT	147 × 102 mm	1
BPM-JUMBO flex	42033	KEL-JUMBO flex	88 × 88 mm	1
BPM-JUMBO 1	42030	KEL-JUMBO 1	116 × 110 mm	1
BPM-JUMBO 2	42032	KEL-JUMBO 2	200 × 116 mm	1
BPM-ULTRA	42633	KEL-ULTRA flex	Ø 168 mm Width: 1.5 mm	1

BPK-SNAP

Blank plates for KEL-SNAP frames

IP54



Blank plate BPK-SNAP to close cut-outs of pre-assembled KEL-SNAP frames.

A snap frame can be closed, i.e. during transport to avoid entry of dust, as long as a KEL frame is not mounted.

The BPK-SNAP blank plate is simply snapped on the KEL frame. There is no tool needed to remove it.

BPK-SNAP 16 and BPK-SNAP 24 for closing cut-outs of the KEL-SNAP mounting frames and unused slide frames of the KDR-ESR gland plates.

Specifications

Material	Polyamide (PA)
Flame class	UL 94 V-0
IP rating	IP54
Temperature	-40°C to +80°C (static)
Properties	Halogen free, silicone free

Compatible with

KEL-SNAP Mounting frames	46 - 49
KDR-ESR Gland plate with Slide frames	258 - 267

Type	Order No.	Blank plate compatible with	Dimensions l x b x h	PU
BPK-SNAP-B	42003	KEL-SNAP-B4	58 × 72.8 × 17 mm	10
BPK-SNAP 10	42004	KEL-SNAP 10	58 × 98.3 × 17 mm	10
BPK-SNAP 16	42007	KEL-SNAP 16	58 × 120 × 17 mm	10
BPK-SNAP 24	42017	KEL-SNAP 24	58 × 147 × 17 mm	10
BPK-SNAP 24-E	42008	KEL-SNAP 24-E	83 × 147 × 17 mm	10



Made in Germany



Free product samples

Customer service

No minimum order value

Custom projects

Global shipping

Certified products



Having trouble finding a solution?
icotek can develop a solution for your individual needs.
Contact us: pm@icotek.com

Thread extension for cable glands and cable entry plates TE-M

The icotek cable glands and cable entry plates with metric thread (pitch 1.5 mm) are screwed together with a locknut during assembly. If the thread lengths are not sufficient, for example when mounting on sandwich panels or thick concrete walls, icotek offers a practical solution: the icotek thread extension!

The icotek thread extension is available in three sizes (M32, M50, M63) and in three lengths (35 mm, 60 mm, 120 mm) and represents a real innovation in the field of cable management. The different lengths can be flexibly combined or shortened at the designated points. This means that not only very large, but also dimensionally accurate distances can be overcome when routing the cable. Due to their stable construction, almost any number of thread extensions can be screwed together. If the cable gland is not supplied with a locknut, this must be ordered as well.

Advantages

- Wide range of applications in different industries such as construction, building services, caravans, cleanroom and more
- Especially suitable for sandwich panels of all wall thicknesses
- IP protection of the cable gland or cable entry plate used remains in place
- Almost endless extension possible
- Different thread lengths can be flexibly combined with each other
- Larger lengths can be shortened at the notch between the threads, without damaging the threads
- Indentation for wrench size for easy tightening of the screw connection
- Available in sizes M32, M50 and M63
- Thread lengths: 35 mm, 60 mm or 120 mm
- Fits to all round icotek cable glands and cable entry plates M32, M50 and M63

Specifications

Material	Polyamide (PA)
Flame class	UL 94 V-0, self-extinguishing
Temperature	- 40°C to + 140°C (static)
Properties	Halogen free, silicone free
Cut-out sizes	37/55/68 mm (standard sizes for hole saws)

Accessories

KVT-ER	54 - 55
KVT	56 - 59
KEL-DPZ	130 - 135
KEL-DPZ-HD	352 - 353
KEL-SCDP-TR	156 - 157
KEL-DPF	160 - 161
Locknut	292



TE-M Thread extension for cable glands and cable entry plates



Type	Thread	Length	External diameter	Wrench size	Order No.	PU
TE-M32 35	M32 x 1,5	35 mm	36,5 mm	SW 35	52300	5
TE-M32 60	M32 x 1,5	60 mm	36,5 mm	SW 35	52301	5
TE-M32 120	M32 x 1,5	120 mm	36,5 mm	SW 35	52302	5
TE-M50 35	M50 x 1,5	35 mm	54,5 mm	SW 53	52310	5
TE-M50 60	M50 x 1,5	60 mm	54,5 mm	SW 53	52311	5
TE-M50 120	M50 x 1,5	120 mm	54,5 mm	SW 53	52312	5
TE-M 63 35	M63 x 1,5	35 mm	67,5 mm	SW 66	52313	5
TE-M 63 60	M63 x 1,5	60 mm	67,5 mm	SW 66	52314	5
TE-M 63 120	M63 x 1,5	120 mm	67,5 mm	SW 66	52315	5



KGM | GMT
Locknuts

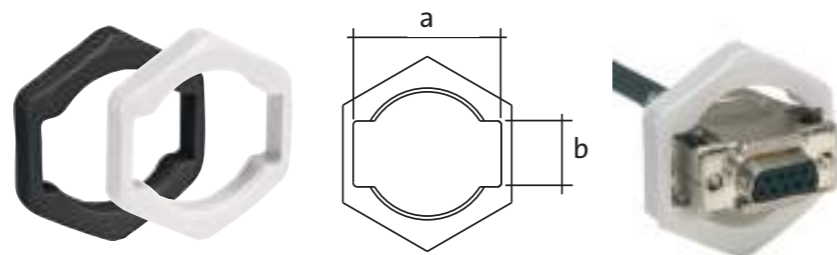

Type KGM: SUB-D9, PB, SUB-D25

Hexagonal locknut with metric threads for attaching components together.

For routing SUB-D, DVI or PROFIBUS connectors in combination with the split cable glands KVT/QVT, special locknuts with suitable cut-outs are required:

KGM-SUB-D9 fits D-Sub 9 connectors
(Required wall cut-out: Ø 36 mm)

KGM-PB fits DVI and PROFIBUS connectors
(Required wall cut-out: Ø 42 mm)

KGM-SUB-D25 fits SUB-D25 connectors
(Required wall cut-out: Ø 50 - 54 mm)

Split hexagonal locknuts GMT for use in combination with split cable glands KVT/QVT whenever pre-terminated cables are routed inside cable protection conduits through a machine or cabinet wall. Suitable for split corrugated conduits CONFIX WST.

Specifications

Material	Polyamide (PA) / Polycarbonate (PC)
Colour	■ grey (similar RAL 7035) ■ black
Flame class	UL 94 V-0, self-extinguishing
Temperature	- 30°C to + 120°C
Properties	Halogen free, silicone free

Thread	Type	Order No.	Material	Height [mm]	Wrench size	Diagonal [mm]	Cut-out a x b [mm]	PU
Type KGM: Standard nut, plastic								
M16 x 1.5	KGM 16	■ 52272	PA	4.3	SW 22.8	28.2	-	10
M20 x 1.5	KGM 20	■ 52273 ■ 52283	PA	7	SW 26	28.2	-	10
M25 x 1.5	KGM 25	■ 52274 ■ 52284	PA	7	SW 32	36	-	10
M32 x 1.5	KGM 32	■ 52275 ■ 52285	PA	7	SW 41	46	-	10
M40 x 1.5	KGM 40	■ 52276 ■ 52286	PA	7	SW 50	56	-	10
M50 x 1.5	KGM 50	■ 52277 ■ 52287	PA	8.5	SW 60	66	-	10
M63 x 1.5	KGM 63	■ 52278 ■ 52288	PA	8.5	SW 75	83	-	5
M75 x 1.5	KGM 75	■ 52289	PA	8.5	SW 85	93.1	-	5
M85 x 2	KGM 85	■ 52290	PA	10	SW 100	109.5	-	5
Type KGM: PB, SUB-D9, SUB-D25								
M32 x 1.5	KGM-SUB-D9	■ 45105 ■ 45106	PC	7	SW 41	46	35 x 16	10
M40 x 1.5	KGM-PB	■ 45107 ■ 45109	PC	8	SW 50	55	43 x 17	10
M50 x 1.5	KGM-SUB-D25	■ 45108 ■ 45110	PC	8	SW 60	66	55 x 16	10
Type GMT: Split locknut								
M16 x 1.5	GMT 16	■ 31105	PA	8	SW 19	21	-	10
M20 x 1.5	GMT 20	■ 31110	PA	9	SW 27	29	-	10
M25 x 1.5	GMT 25	■ 31100	PA	9	SW 32	35	-	10
M32 x 1.5	GMT 32	■ 31120	PA	12	SW 40	44	-	10
M40 x 1.5	GMT 40	■ 31130	PA	15	SW 48	53	-	10
M50 x 1.5	GMT 50	■ 31140	PA	15	SW 63	69	-	10



Type KGM: Standard nut, plastic



Type GMT: Split locknut

MF

Supports for top hat DIN rails and bus bars



Description	Type	Version	Order No. without Clip	Order No. with Clip	Dimension [L x B x H]	PU
Type A						
	MF-A49	Type A	36056	36058	80 x 20 x 49 mm	10
	MF-A68	Type A	36064	36066	80 x 20 x 68 mm	10
	MF-A88	Type A	36072	36074	80 x 20 x 88 mm	10
Type B						
	MF-B20	Type B	36000	36002	80 x 20 x 20 mm	10
	MF-B30	Type B	36008	36010	80 x 20 x 30 mm	10
	MF-B50	Type B	36016	36018	80 x 20 x 50 mm	10
	MF-B90	Type B	36024	36026	80 x 20 x 90 mm	10
Type C						
	MF-C40	Type C	36032	36034	40 x 18 x 40 mm	10
	MF-C53	Type C	36040	36042	40 x 18 x 53 mm	10
	MF-D49	Type D	36048	36050	120 x 20 x 49 mm	10

Bus bar 10 x 3 mm

Type	Order No.	PU	
Bus bar 10 x 3 mm	10 x 3 x 1000 mm*	36100	1

* Other lengths available on request

There are 4 models of supports for mounting bus bars 10 x 3 mm or 35 mm top hat DIN rails. Various supports are available to provide solutions for different conditions.

A mounting clip is used for fastening the bus bar to the supports. The support has M6 female screw threads to affix the mounting clip of the DIN rail with a M6 screw.

Advantages & benefits

- Wide variety of supports with different sizes and designs
- Simple assembly of top hat DIN rails and 10 x 3 mm bus bars
- Support type D provides possibility to affix 2 top hat DIN rails

Specifications

Material Sheet steel, galvanically zinc-plated

Accessories

Bus bar	Order No. 36100
Mounting clip	Order No. 36150

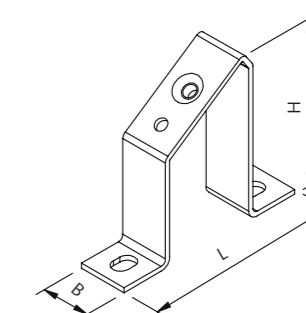

Sealing material

Sealing bead

Self-adhesive foamed PU seal

The KDR-BMP enclosure base plates have a foamed PU seal glued to the underside. icotek now also offers this separately for individual applications.

The PU seal is applied to a self-adhesive carrier film and is available in 2 widths. The length is 2150 mm in each case. The height of the seal is determined by the respective width. The PU seal is easy to compress and has very good recovery properties.

Advantages

- Very simple and quick installation
- Easy laying around corners
- Very good recovery properties

Specifications

Material	PU foam
Temperature	-40°C to 80°C
Properties	halogen free, silicone free

Type	NEW	Length	Width	Height	Order No.	PU
Sealing bead		2150 mm	6 mm	3.5 mm	43347	5
Sealing bead		2150 mm	9 mm	5 mm	43348	5



Installing the PUR seal is very easy: remove the protective film, stick it on, done!

Sealing tape

icotek offers a one-sided self-adhesive sealing tape for the enclosure base plates. It is available in two lengths, 1 metre and 10 metres long.

Advantages

- Very simple and quick installation
- Very good recovery properties

Specifications

Material	Cellular rubber (CR/NBR)
Temperature	-40°C to +100°C
Flame class	UL 94-HF1

Type	Length	Width	Height	Order No.	PU
Sealing tape	1 m	10 mm	3 mm	42999	1
Sealing tape	10 m	10 mm	3 mm	42999.10000	1

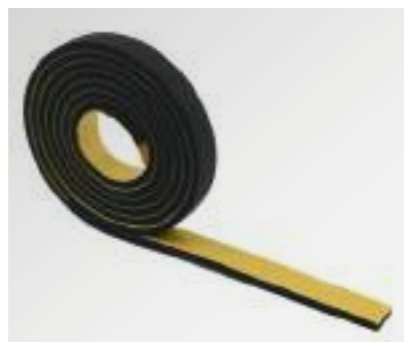

Drainage device Pressure compensation element



Type	Dimension Ø	Cut-out Ø	Order No.	PU
Drainage Device for M50 hole	60 mm	50 mm	99193	1

Assembly

The drainage device is fixed in the bottom of the enclosure using the union nut in a hole of Ø 50.5 +0.5 mm. Make sure that the sealing ring is on the outer housing wall and that the hole is free of burrs.

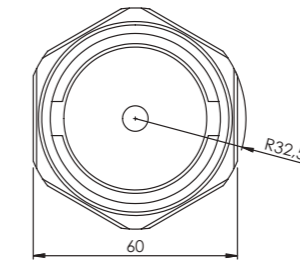
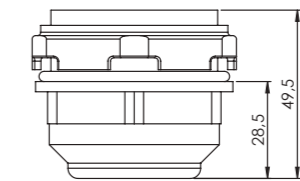

Drainage device

In enclosures and housings with a high degree of protection, temperature differences result in condensation. By using a drainage device, it is possible to safely drain off the condensate without losing a maximum enclosure protection of IP66. A water-permeable membrane ensures the drainage of the enclosure due to its capillary effect. The design prevents splash water from entering the interior of the enclosure.

Advantages & benefits

- High protection class IP66/67, IP69K
- Good drainage performance
- Easy assembly
- Based on a standard cut-out
- Sturdy, weatherproof and UV-resistant housing

Specifications

Water entry level	0 mm (at 0.5 mm wall thickness)
Gasket	Sealing gasket NBR
Water permeability	approx. 200 ml/h with a water column of 5 mm
Mounting position	horizontal, lowest point
Temperature	-45 to +70°C

Pressure compensation element

with metric thread

The pressure compensation element PCE with M12 x 1.5 thread is used to avoid variations in pressure caused by differences in temperature and thus to prevent damage caused by condensation. It provides protection class IP68. The pressure compensation element is easy to install by screwing it directly into the enclosure wall or via adapter grommets AT-K-M 12x1.5.

Specifications

Material	Polyamide
Flame class	UL 94 V-2
Protection class	IP67, IP68
Temperature	-20°C to +100°C

Type	Order No.	Thread	PU
PCE M12 x 1.5	99190	M12 x 1.5	10



KVT-ER 63|4 equipped with pressure compensation element

7 Cable pass-through with brush seal

Brush plates and brush strips for enclosures, server racks and machines

RoHS compliant Made in Germany

icotek offers cable pass-through solutions with brush seals that are perfectly suitable for applications where no high sealing rate is required. The icotek brush seal solutions are meant for dust and dirt-proof cable pass-through of cables with and without preassembled connectors.

The application areas for a cable pass-through with brush seal are very versatile, e.g. in an electrical enclosure, a server rack, on a machine wall or on raised floors. icotek brush plates and brush strips are a cost-effective solution for a professional cable management.

The brush seal solutions allow reduced airflow while filtering out dust and larger particles. Thermal protection and visual screening are additional benefits. icotek brush plates also protect cables against wear due to sharp edges of the cut-out.

For cable pass-through applications in base areas of enclosures and server racks by numerous manufacturers and for wide cut-outs on machine walls icotek offers the universal brush strip KDR-BES-U. Due to the innovative clamp profile the brush strip can be clamped on any sheet metal edge, even in a 90° angle.

The 2-piece enclosure gland plates KDR-BES and flange plates FP-AX-BES are pre-equipped with brush strips and serve as dust- and dirt-tight cable pass-through.

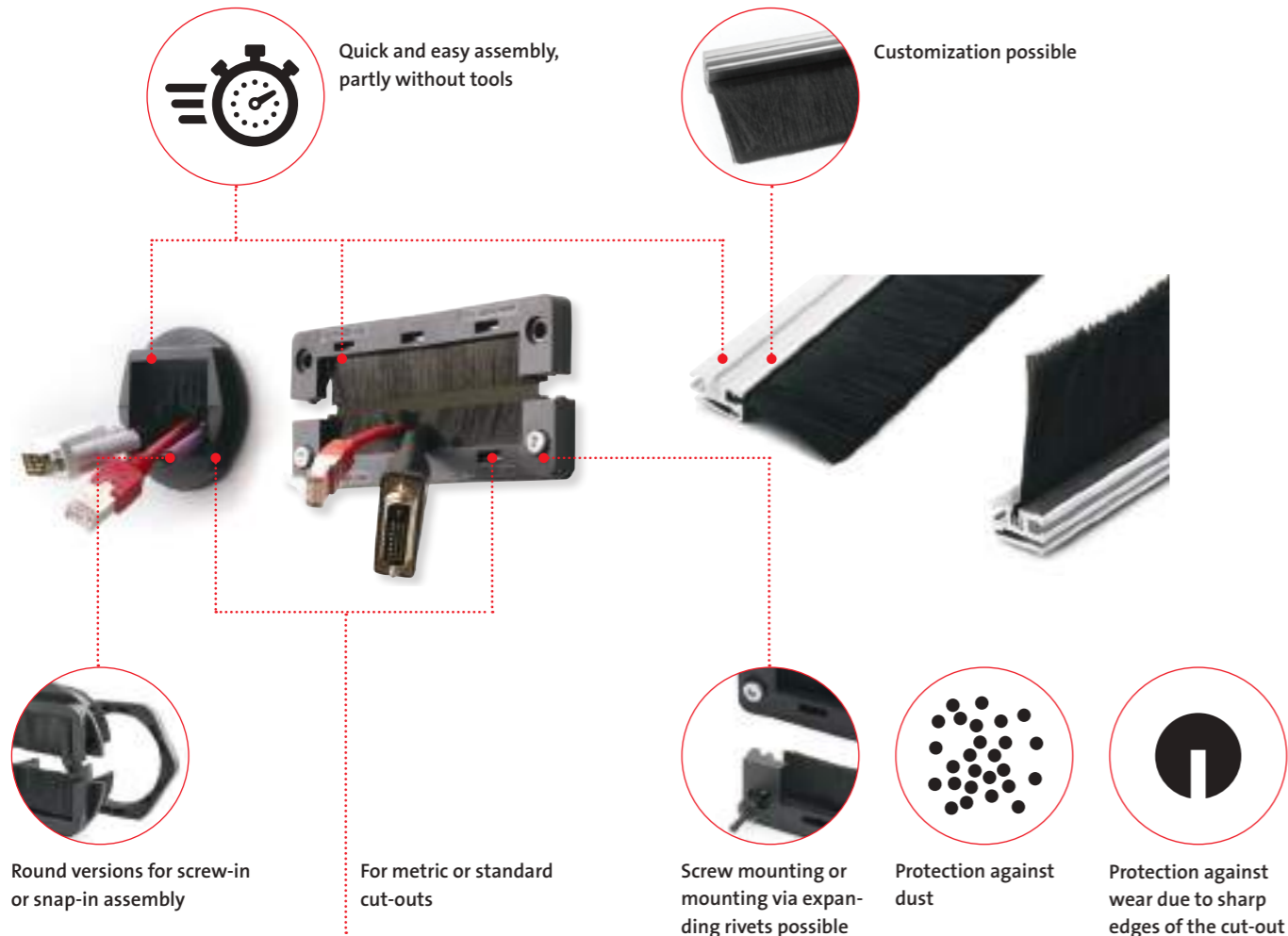

7.1 Brush plate for cable pass-through

		
Brush plate for cable pass-through for standard cut-outs	Split brush plate for cable pass-through for standard cut-outs	Thread extension for cable glands and cable entry plates M32, M50, M63
KEL-BES	KEL-BES-S	TE-M
298	299	290 – 291

7.2 Brush strips, gland plates and flange plates with brush strips

		
Rittal/Hoffman/Others Universal brush strip for enclosures	Rittal Enclosure gland plates with brush grommets	Rittal Split flange plates with brush strips
KDR-BES-U / KDR-BES-U... series	KDRS-BES-U / KDR-BES-TS8	FP-AX-BES-U
300 – 305	306 – 309	310 – 311

7.3 Brush strips for the cable management in the 10" and 19" server rack

	
Brush strips for the cable management in the 10" server rack from various manufacturers	Brush strips for the cable management in the 19" server rack from various manufacturers
BES 10	BES 19
312 – 313	312 – 313

KEL-BES Brush plate for cable pass-through



Brush plates KEL-BES for routing cables into server racks, control panels and electrical enclosures. KEL-BES is also an ideal solution for entry and exit of cables that are routed inside raised floors, e.g. in datacentres or IT closets. The brush plates can either be mounted via screws or via expanding rivets.

The KEL-BES plates match exactly the cut-out dimensions for 10-, 16- or 24-pin standard industrial connectors.

Advantages & benefits

- Fast and easy assembly (optional: snap in assembly)
- Versatile utilisation
- Filtering out dust, hair and larger particulate matter
- Visual screening
- Protects cables against wear due to sharp edges of the cut-out
- For industrial standard cut-outs

Specifications

Material Frame, rectangular: Polyamide (PA) (Flame class UL 94 V-0)
Brushes: Polyamide (PA)
Brush profile: sheet steel, zinc plated

Temperature -20°C to +90°C

Properties Halogen-free, silicone-free

Frame depth 10 mm

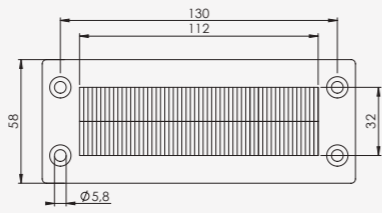
Description	Type	Order No.	Cut-out	PU
	KEL-BES 24	51515	36 x 112 mm	10

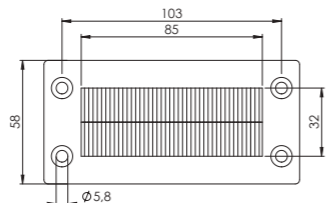
	KEL-BES 16	51510	36 x 86 mm	10
--	------------	-------	------------	----

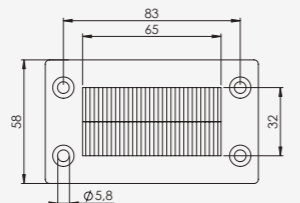
	KEL-BES 10	51505	36 x 65 mm	10
---	------------	-------	------------	----

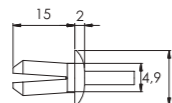
	Expanding rivets	99153	For wall thickness 1-4 mm	100
---	------------------	-------	---------------------------	-----



Suitable for control panel construction



... as well as for energy and building technology



Screw mounting or mounting via expanding rivets possible



Round version with M50 thread for locknut or snap-in mounting

KEL-BES-S Split brush plate for cable pass-through

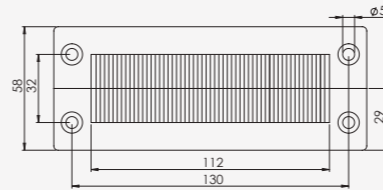

Description	Type	Order No.	Cut-out	PU
	KEL-BES-S 24	51522	36 x 112 mm	10
	KEL-BES-S 24 with expanding rivets	51522.002	36 x 112 mm	10

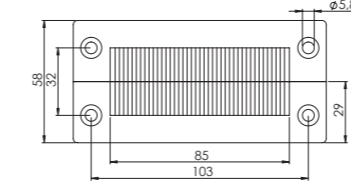
	KEL-BES-S 16	51521	36 x 86 mm	10
	KEL-BES-S 16 with expanding rivets	51521.002	36 x 86 mm	10

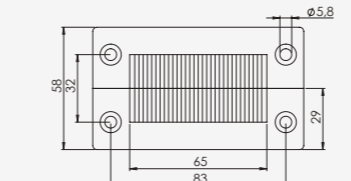
	KEL-BES-S 10	51520	36 x 65 mm	10
	KEL-BES-S 10 with expanding rivets	51520.002	36 x 65 mm	10

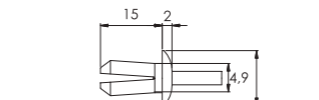
	Expanding rivets	99153	For wall thickness 1-4 mm	100
---	------------------	-------	---------------------------	-----

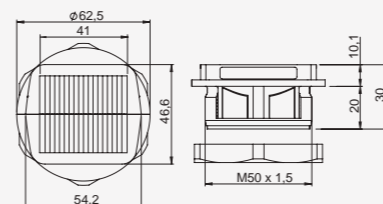
	KEL-BES-S 50	51540	M50 x 1.5 Snap-in function for wall thickness 1-2.5 mm	10
---	--------------	-------	---	----

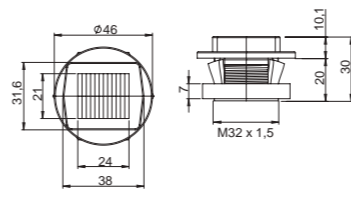
	KEL-BES-S 32	51538	M32 x 1.5 Snap-in function for wall thickness 1-2.5 mm	10
---	--------------	-------	---	----

Split brush plates KEL-BES-S for routing cables into server racks, control panels and electrical enclosures. The brush plates can either be mounted via screws or via expanding rivets. Due to the split frame the KEL-BES-S can also be subsequently installed around the routed cables. The KEL-BES-S frames match exactly the cut-out dimensions for 10-, 16- or 24-pin standard industrial connectors.

For round metric cut-outs M32/M50 icotek offers the split KEL-BES-S 32/50. It can be either directly snapped into the cut-out or screwed with a locknut (included in the shipment).

Advantages & benefits

- Fast and easy assembly (optional: snap in assembly)
- Subsequent assembly possible
- Versatile utilisation
- Filtering out dust, hair and larger particulate matter
- Visual screening
- Protects cables against wear due to sharp edges of the cut-out
- For industrial standard cut-outs

Specifications

Material Frame, rectangular: Polyamide (PA)
Frame, round: Polycarbonate (PC) (Flame class UL94-Vo)
Brushes: Polyamide (PA)
Brush profile: sheet steel, zinc plated

Temperature -20°C to +90°C

Properties Halogen-free, silicone-free

Frame depth 10 mm

Accessories

KEL-EMC-PF Cable collectors 225
TE-M 290-291



KDR-BES-U Universal brush strip for enclosures

Cable pass-through brush strip for enclosure bases or individual cut-outs on cabinets, enclosures, panels, server racks or machine walls. Due to the innovative and universal clamp strip the brush can also be assembled in a 90° angle, e.g. on bent sheet metal. Suitable for wall thickness 1.5 - 2 mm or 2.5 - 3 mm. Brush may be removed from the profile at any time and remounted using other mounting options.

The KDR-BES-U brush strip is adaptable to almost any enclosure or cabinet type on the market. The standard gland plates included in the enclosure delivery can be used for assembly. They do not have to be changed.

Advantages & benefits

- Fast, simple and tool-free mounting
- Original enclosure gland plates can be used
- Three mounting types possible
- Brush may be remounted at any time using other mounting options
- Available in any custom length up to 1.500 mm

Specifications

Material clamp strip	Aluminium
Material backing strips	Metal, galvanised
Material bristles	Polyamide (PA)
For sheet thickness	1.5 – 2 mm, 2.5 – 3 mm
Temperature	-20°C to +90°C
Properties	Halogen free, silicone free



Brush strips in your required length (up to 1.500 mm)

X (mm) = sight size of base opening
X max. = 1500 mm

Order numbers examples:

For sheet thickness 1.5 – 2 mm, trim height 35 mm:
X = 999 mm → Order No. 58210.0999

For sheet thickness 2.5 – 3 mm, trim height 35 mm:
X = 999 mm → Order No. 58225.0999

For sheet thickness 1.5 – 2 mm, trim height 50 mm:
X = 999 mm → Order No. 58215.0999

For sheet thickness 2.5 – 3 mm, trim height 50 mm:
X = 999 mm → Order No. 58230.0999

Scope of delivery:

1x KDR-BES-U (clamp strip + brush)

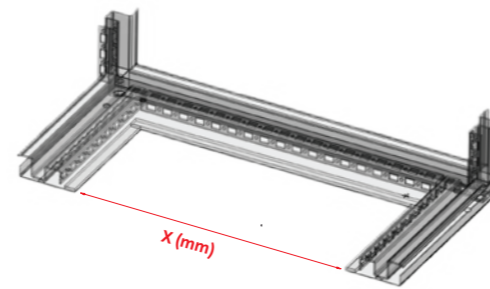

KDR-BES-U mounting options

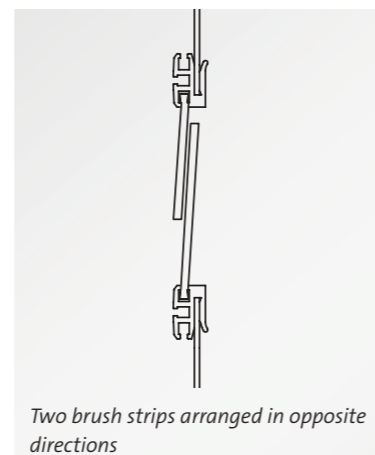
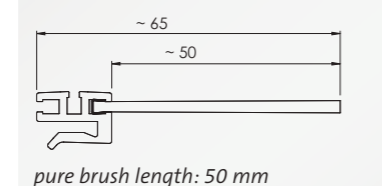
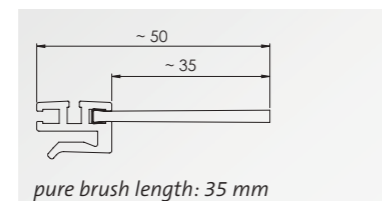
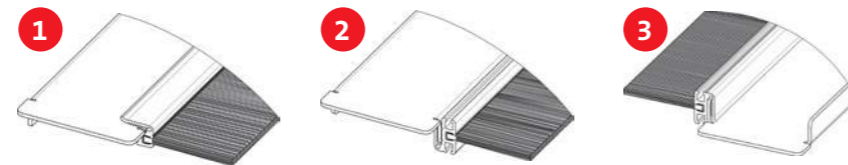

KDR-BES-U Brush strip for gland plates Rittal VX25/TS8 & Hoffman PROLINE G2



Type	Enclosure type	Enclosure width	Brush strip length	Trim height	Order no.	PU
KDR-BES-U for Rittal VX25 enclosures						
KDR-BES-U-VX25-600	Rittal VX25	600 mm	452 mm	35 mm	58225.0452	1
KDR-BES-U-VX25-800	Rittal VX25	800 mm	652 mm	35 mm	58225.0652	1
KDR-BES-U-VX25-1000	Rittal VX25	1000 mm* with division bar	402 mm	35 mm	58225.0402	1
KDR-BES-U-VX25-1200	Rittal VX25	1200 mm* with division bar	502 mm	35 mm	58225.0502	1
KDR-BES-U-VX25-600	Rittal VX25	600 mm	452 mm	50 mm	58230.0452	1
KDR-BES-U-VX25-800	Rittal VX25	800 mm	652 mm	50 mm	58230.0652	1
KDR-BES-U-VX25-1000	Rittal VX25	1000 mm* with division bar	402 mm	50 mm	58230.0402	1
KDR-BES-U-VX25-1200	Rittal VX25	1200 mm* with division bar	502 mm	50 mm	58230.0502	1
KDR-BES-U for Rittal TS8 enclosures						
KDR-BES-U-TS8-600	Rittal TS8	600 mm	435 mm	35 mm	58210.0435	1
KDR-BES-U-TS8-800	Rittal TS8	800 mm	635 mm	35 mm	58210.0635	1
KDR-BES-U-TS8-1000	Rittal TS8	1000 mm* with division bar	397 mm	35 mm	58210.0397	1
KDR-BES-U-TS8-1000	Rittal TS8	1000 mm without division bar	835 mm	35 mm	58210.0835	1
KDR-BES-U-TS8-1200	Rittal TS8	1200 mm* with division bar	495 mm	35 mm	58210.0495	1
KDR-BES-U for Hoffman PROLINE G2 enclosures						
KDR-BES-U-HG2-600	Hoffman PROLINE G2	600 mm / 1200 mm*	362 mm	35 mm	58210.0362	1
KDR-BES-U-HG2-800	Hoffman PROLINE G2	800 mm	562 mm	35 mm	58210.0562	1
KDR-BES-U-HG2-1000	Hoffman PROLINE G2	1000 mm	762 mm	35 mm	58210.0762	1
Edge protection trim	universal	Clamping range 1-2 mm			99152	100 m



Edge protection trim (100 m)
Order No. 99152

* in case both fields of the enclosure are equipped, 2 brush strips KDR-BES-U are necessary.

KDR-BES-U
Brush strip
for Häwa enclosures



Type	Enclosure type	Enclosure width	Brush strip length	Trim height	Order no.	PU
KDR-BES-U for Häwa enclosures series H395 and series H390						
KDR-BES-U HW-600	Häwa	600 mm	392 mm	35 mm	58210.0392	1
KDR-BES-U HW-800	Häwa	800 mm	592 mm	35 mm	58210.0592	1
KDR-BES-U HW-1000	Häwa	1000 mm	792 mm	35 mm	58210.0792	1
KDR-BES-U HW-1200	Häwa	1200 mm	992 mm	35 mm	58210.0992	1
KDR-BES-U HW-600	Häwa	600 mm	392 mm	50 mm	58215.0392	1
KDR-BES-U HW-800	Häwa	800 mm	592 mm	50 mm	58215.0592	1
KDR-BES-U HW-1000	Häwa	1000 mm	792 mm	50 mm	58215.0792	1
KDR-BES-U HW-1200	Häwa	1200 mm	992 mm	50 mm	58215.0992	1

These brush strips KDR-BES-U are suitable for Häwa enclosures series H395 and series H390.

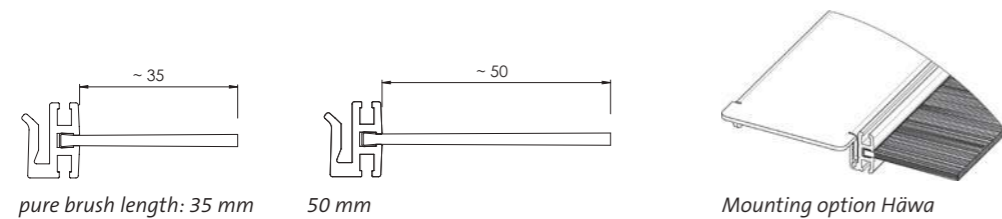

KDR-BES-U
Brush strip
for Schneider Electric enclosures



Type	Enclosure type	Enclosure width	Brush strip length	Trim height	Order no.	PU
KDR-BES-U for Schneider Electric enclosures series Spacial SF						
KDR-BES-U SSP-600	Schneider Electric	600 mm	414 mm	35 mm	58210.0414	1
KDR-BES-U SSP-800	Schneider Electric	800 mm	614 mm	35 mm	58210.0614	1
KDR-BES-U SSP-1000	Schneider Electric	1000 mm	814 mm	35 mm	58210.0814	1
KDR-BES-U SSP-1200	Schneider Electric	1200 mm *	477 mm	35 mm	58210.0477	1
KDR-BES-U SSP-600	Schneider Electric	600 mm	414 mm	50 mm	58215.0414	1
KDR-BES-U SSP-800	Schneider Electric	800 mm	614 mm	50 mm	58215.0614	1
KDR-BES-U SSP-1000	Schneider Electric	1000 mm	814 mm	50 mm	58215.0814	1
KDR-BES-U SSP-1200	Schneider Electric	1200 mm *	477 mm	50 mm	58215.0477	1

These brush strips KDR-BES-U are suitable for Schneider Electric enclosures series Spacial SF.

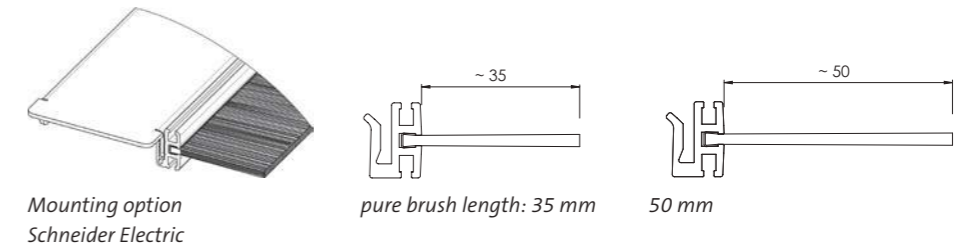

i icotek also produces brush strips for numerous other enclosure brands and in other sizes according to your wishes. Ask us at pm@icotek.com!

KDR-BES-U
Brush strip
for ELDON enclosures



Type	Enclosure type	Enclosure width	Brush strip length	Trim height	Order no.	PU
KDR-BES-U for ELDON/nVent enclosures type MCD, MCS, MKS und MKD						
KDR-BES-U Eldon 600	ELDON/nVent	600 mm	435 mm	35 mm	58221.0435	1
KDR-BES-U Eldon 800 + 1600	ELDON/nVent	800 mm 1600 mm *	635 mm	35 mm	58221.0635	1
KDR-BES-U Eldon 1000	ELDON/nVent	1000 mm	835 mm	35 mm	58221.0835	1
KDR-BES-U Eldon 1200	ELDON/nVent	1200 mm *	495 mm	35 mm	58221.0495	1
KDR-BES-U Eldon 600	ELDON/nVent	600 mm	435 mm	50 mm	58222.0435	1
KDR-BES-U Eldon 800 + 1600	ELDON/nVent	800 mm 1600 mm *	635 mm	50 mm	58222.0635	1
KDR-BES-U Eldon 1000	ELDON/nVent	1000 mm	835 mm	50 mm	58222.0835	1
KDR-BES-U Eldon 1200	ELDON/nVent	1200 mm *	495 mm	50 mm	58222.0495	1

These brush strips KDR-BES-U are suitable for ELDON/nVent enclosures type MCD, MCS, MKS und MKD.

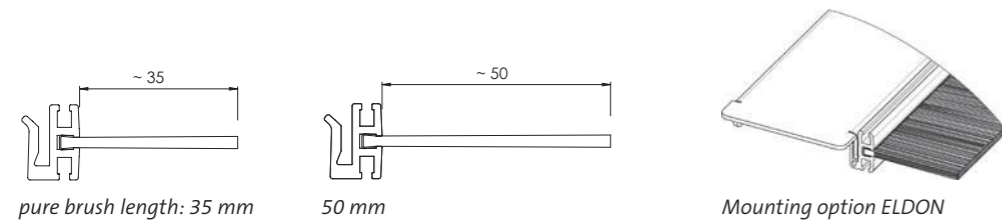

i icotek also produces brush strips for numerous other enclosure brands and in other sizes according to your wishes. Ask us at pm@icotek.com!

KDR-BES-U
Brush strip
for ETA enclosures



Type	Enclosure type	Enclosure width	Brush strip length	Trim height	Order no.	PU
KDR-BES-U for ETA enclosures type E NUX						
KDR-BES-U 600 ETA E NUX	ETA	600 mm	363 mm	35 mm	58221.0363	1
KDR-BES-U 800 ETA E NUX	ETA	800 mm	563 mm	35 mm	58221.0563	1
KDR-BES-U 1000 ETA E NUX	ETA	1000 mm *	345 mm	35 mm	58221.0345	1
KDR-BES-U 1200 ETA E NUX	ETA	1200 mm *	445 mm	35 mm	58221.0445	1
KDR-BES-U 600 ETA E NUX	ETA	600 mm	363 mm	50 mm	58222.0363	1
KDR-BES-U 800 ETA E NUX	ETA	800 mm	563 mm	50 mm	58222.0563	1
KDR-BES-U 1000 ETA E NUX	ETA	1000 mm *	345 mm	50 mm	58222.0345	1
KDR-BES-U 1200 ETA E NUX	ETA	1200 mm *	445 mm	50 mm	58222.0445	1

These brush strips KDR-BES-U are suitable for ETA enclosures type E NUX.

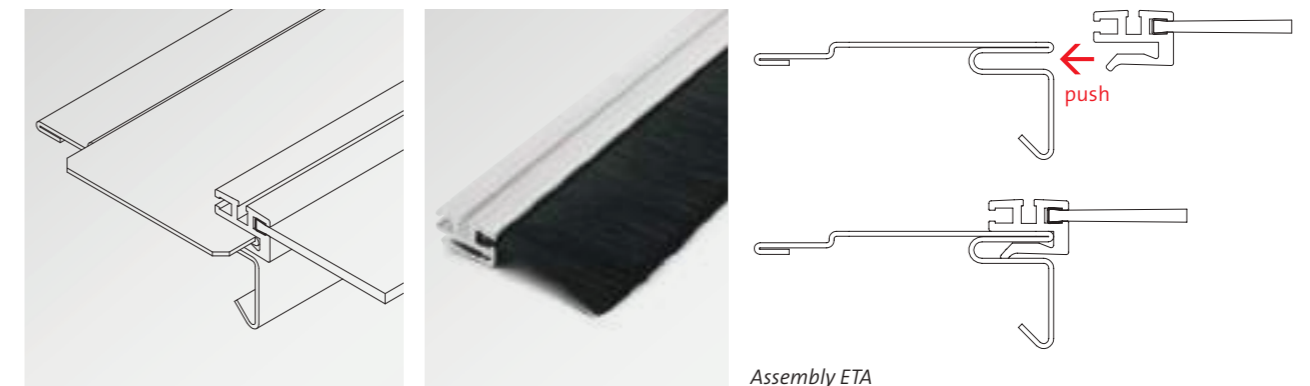
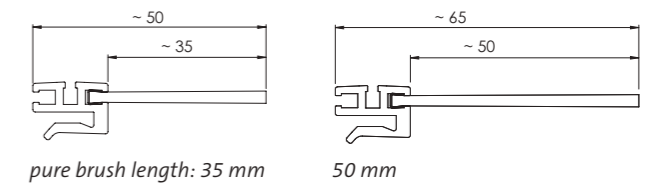

Assembly ETA

* in case both fields of the enclosure are equipped, 2 brush strips KDR-BES-U are necessary.

KDRS-BES-U

Enclosure gland plate, narrow, with brush strips for Rittal VX25 enclosures

The KDRS-BES-U consists of a narrow plate with matching brush strip with trim height 50 mm. The scope of delivery also includes a KDR-BES-U brush strip for sheet thicknesses of 2.5 – 3.0 mm with a trim height of 50 mm, which is mounted on the Rittal base plate. As a result, both brush strips are arranged in opposite directions and overlap.

The KDRS-BES-U gland plate with brush strip is very narrow. This allows the inserted cables to be inserted straight into the wiring duct.

The gland plate is fitted with threaded screw holes M8 on the left and right for earthing.

The gland plates KDRS-BES-U are designed for Rittal enclosures VX25.

Advantages & benefits

- Easy assembly and removal
- The gland plate is very narrow. As a result, the inserted cables are inserted straight into the cable duct.
- Ideal for maintenance and retrofitting
- Space-saving solution
- The gland plate KDRS-BES-U are designed for Rittal enclosures VX25. Other sizes can be supplied on request.

Specifications

Material Gland plate: Sheet steel, zinc-plated
Brush strip: Polyamid (PA)
Temperature -20°C to +90°C (static)
Properties Halogen free, silicone free

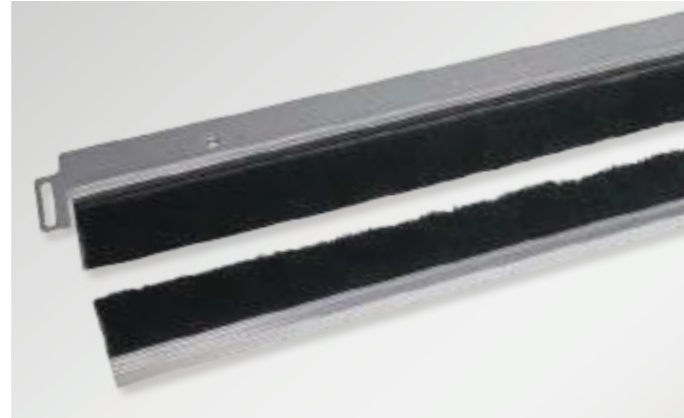

Advantage KDRS: Straight cable routing into the cable duct due to the extremely narrow gland plate

i icotek can also produce enclosure gland plates for numerous other enclosure brands and in other sizes according to your wishes. Ask us at pm@icotek.com!

KDRS-BES-U
Enclosure gland plate, narrow, with brush strips for Rittal VX25 enclosures



Type	Enclosure type	Enclosure width	Sight size of base plate opening	Trim height	Order no.	PU
KDR-BES-U for Rittal enclosures VX 25						
KDRS-BES-U VX-25-600	VX 25	600 mm	452 mm	50 mm	58030	1
KDRS-BES-U VX-25-800	VX 25	800 mm	652 mm	50 mm	58031	1
KDRS-BES-U VX-25-1000	VX 25	1000 mm *	402 mm	50 mm	58032	1
KDRS-BES-U VX-25-1200	VX 25	1200 mm *	502 mm	50 mm	58033	1

* in case both fields of the enclosure are equipped, 2 complete gland plates are necessary.

KDR-BES

Enclosure gland plate with brush grommets

The 2-piece enclosure gland plates KDR-BES are supplied with preassembled brush grommets.

The gland plates are installed with standard Rittal clips.

Depending on the maximum cable diameter to be routed, the 2 halves of the brush gland plate are aligned further or closer to each other.

The gland plates KDR-BES are perfect for protection of the enclosure interiors against dirt.

Advantages & benefits

- During assembly, almost the complete base of the enclosure can be used for installation of cables.
- Retrofitting is possible without disconnecting of cables. All can be installed around the cables.
- The gland plates KDR-BES are designed for Rittal enclosures TS8. Other sizes can be supplied on request.

Specifications

Material Gland plate: Sheet steel, zinc-plated
Brush grommets: Polyamide (PA)

Temperature -20°C to +90°C (static)

Properties Halogen free, silicone free

KDR-BES Assembly



KDR-BES
Enclosure gland plate with brush grommets

Type	Enclosure type	Enclosure width	Total length gland plate	Sight size of base plate opening	Order No.
KDR-BES-TS 8-600	Rittal TS8	600 mm	458 mm	435 mm	58000
KDR-BES-TS 8-800	Rittal TS8	800 mm	658 mm	635 mm	58006
KDR-BES-TS 8-1000	Rittal TS8	1000 mm without division bar	858 mm	835 mm	58012
KDR-BES-TS 8-1200	Rittal TS8	1200 mm*	518 mm	495 mm	58018

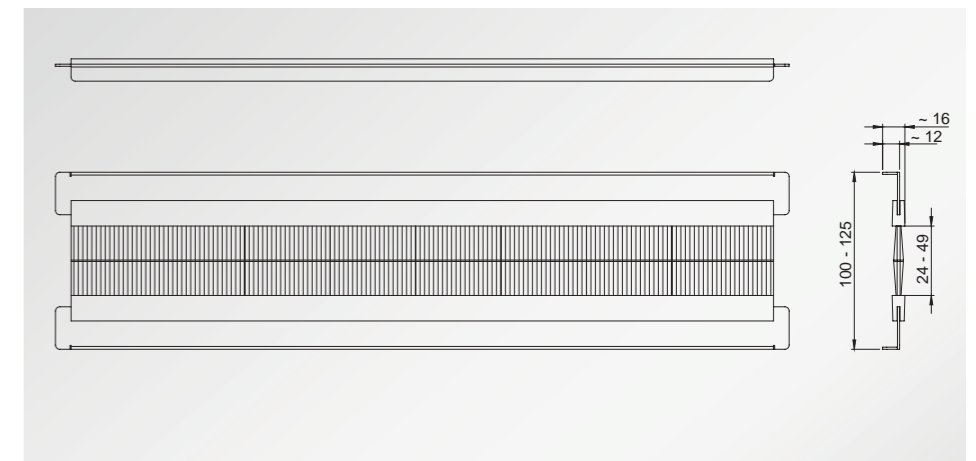

* in case both fields of the enclosure are equipped, 2 complete gland plates are necessary.

FP-AX-BES-U

Split flange plates with brush strips

Two-part flange plates, each with two brush strips arranged in opposite directions with different trim heights (1 x 35 mm and 1 x 50 mm). They enable the routing of cables already pre-assembled with connectors and prevent dirt from entering the enclosure. The flange plates are designed for Rittal enclosures of type AX.

Advantages & benefits

- Easy assembly
- Proven brush solution
- The use of two overlapping brush strips arranged in opposite directions increases tightness
- Ready for installation

Specifications

Flange plate	Sheet steel glossy powder-coated, RAL 7035
Brush profile	Aluminium
Brush holder	Metal, galvanised
Bristles	Polyamide (PA)
Temperature	-20°C bis +90°C
Properties	Halogen free, silicone free



FP-AX-BES-U

Split flange plates with brush strips

Description

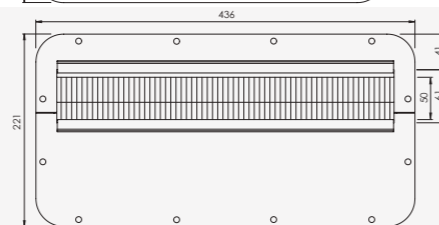
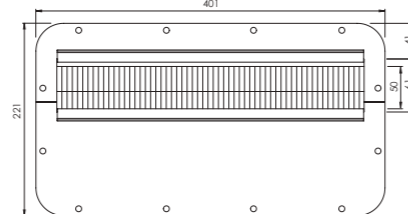
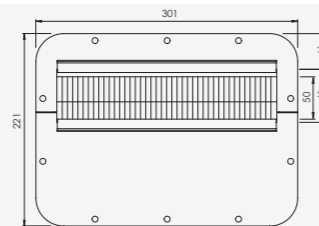
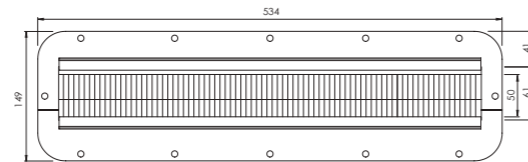
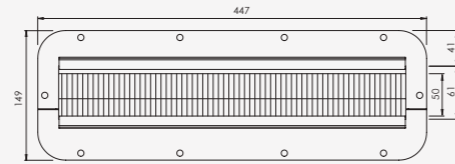
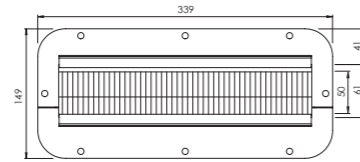
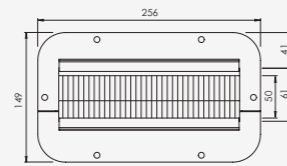

Type	Size flange plate	suitable for	Order No.
FP-AX-BES-U 256 x 149 mm, two-part, mounted with KDR-BES-U trim height 35 mm + 50 mm	1	AX 1033.000 AX 1034.000	44100
FP-AX-BES-U 339 x 149 mm, two-part, mounted with KDR-BES-U trim height 35 mm + 50 mm	2	AX 1031.000 AX 1380.000 AX 1038.000 AX 1077.000 AX 1100.000 AX 1045.000	44101
FP-AX-BES-U 447 x 149 mm, two-part, mounted with KDR-BES-U trim height 35 mm + 50 mm	3	AX 1050.000 AX 1057.000	44102
FP-AX-BES-U 534 x 149 mm, two-part, mounted with KDR-BES-U trim height 35 mm + 50 mm	4	AX 1039.000 AX 1060.000 AX 1054.000 AX 1076.000 AX 1058.000 AX 1090.000	44103
FP-AX-BES-U 301 x 221 mm, two-part, mounted with KDR-BES-U trim height 35 mm + 50 mm	5	AX 1338.000 AX 1037.000 AX 1073.000 AX 1055.000 AX 1180.000 AX 1280.000 AX 1181.000 AX 1281.000	44104
FP-AX-BES-U 401 x 221 mm, two-part, mounted with KDR-BES-U trim height 35 mm + 50 mm	6	AX 1350.000 AX 1130.000 AX 1110.000 AX 1213.000 AX 1114.000 AX 1214.000 AX 1115.000	44105
FP-AX-BES-U 436 x 221 mm, two-part, mounted with KDR-BES-U trim height 35 mm + 50 mm	7	AX 1339.000 AX 1360.000 AX 1376.000 AX 1260.000 AX 1116.000 AX 1059.000 AX 1091.000 AX 1261.000	44106

icotek also produces flange plates with brush strips for numerous other enclosure brands. Ask us at pm@icotek.com!



BES 10 | BES 19

Brush strips for the cable management in the 10" and 19" server rack

This brush strip from icotek is suitable for installation in 10" or 19" server racks from various manufacturers.

The special feature of the BES brush strip is that the integrated spring locks allow tool-free assembly and disassembly. All that is needed is to release the locking mechanism on both sides.

The network cables are simply passed through the brush strip. The cables are hidden from view inside the network cabinet. This gives a tidy appearance. The brush strip also prevents the ingress of dirt.

Advantages

- Suitable for 10" and 19" server racks from various manufacturers
- Tool-free assembly and disassembly
- Ready for installation

Specifications

Size	1 Rack Unit (1 RU)
Frame material	Metal
Bristles material	Polyamid (PA)
Colour	Black
Temperature	-30°C to +80°C



BES 10 | BES 19
Brush strips for the cable management in the 10" and 19" server rack



Type	Enclosure type	Height	Length	Depth	Order No.	PU
BES 19 Cable management brush strip	Server rack 19"	44,5 mm	482 mm	12 mm	51500	1
BES 10 Cable management brush strip	Server rack 10"	44,5 mm	254 mm	12 mm	51501	1

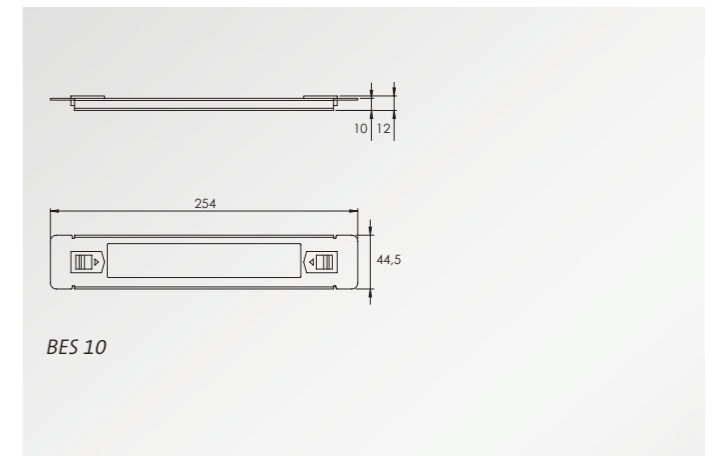
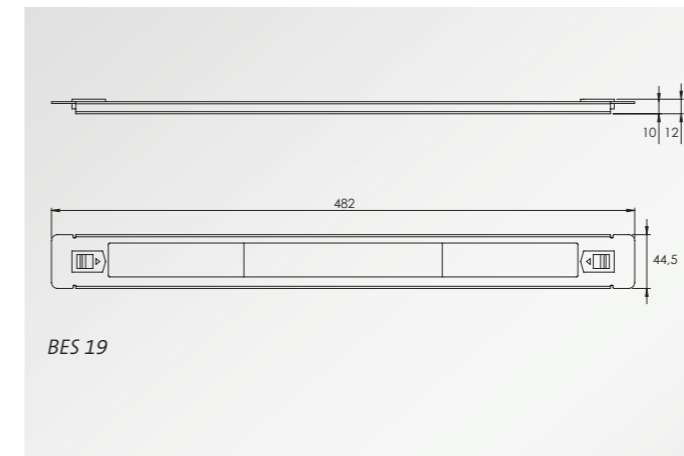

8 icotek TOOLS

Punch drivers, knockout punches & useful tools

icotek offers a small-sized hand hydraulic punch driver without a hose which allows quick and easy punching of rectangular, square or round holes. When you have to punch several holes, this hand hydraulic punch driver is much faster than manual wrench-style punches.

icotek offers round knockout punches for cut-outs in metric and PG sizes. This self-centering knockout punches split slugs into 2 or 3 pieces for easy slug removal. For installation of pushbuttons and round switches icotek offers a 22.5 mm punch with integrated twist protection notch.

icotek also offers rectangular and square punches and dies, for cut-out sizes of 6-, 10-, 16-, 24- and 32-multi-pin industrial connectors as well as for most icotek cable entry systems.

Advantages & benefits

1. Maximum flexibility

Due to its high hydraulic force the compact, lightweight hand hydraulic punch driver makes it easy to punch holes into stainless V2A steel, mild steel, aluminium or plastics. The cylinder of the punch driver rotates 360° on 3 axles. Therefore, maximum flexibility even in hard-to-reach places is provided.

2. Multi-fold slug splitting

The special cutting geometry of the round punches reduces the cutting pressure and therefore the required effort. The punch splits slugs into several pieces for easy slug removal (type related).

3. Perfect for icotek cable entry components

The metric round, rectangular & square knockout punches can be used for industrial standard cut-outs of heavy multi-pin connectors and many icotek cable entry components.



Rail cutters
for top hat DIN rails and bus bars
DIN-RC 1 / DIN-RC 2

316



Punch driver sets
Hand hydraulic punch driver
& round knockout die set, metric,
Hydraulic Foot Pump

317



Rectangular & square punches
for cut-outs of heavy multi-pin industrial
connectors and many icotek cable entry
components

318 – 319



Round punches
for cut-outs in PG and metric sizes,
for steel, aluminium, stainless steel

320 – 321



Punches CONFIX
for CONFIX cable conduit system
and KEL-FW cable entry,
for steel, aluminium, stainless steel

322



Useful Tools
for measuring and mounting

323



DIN-RC 1 | DIN-RC 2

Rail cutters for top hat DIN rails and bus bars



The DIN-RC 1 and DIN-RC 2 cutters cut various top hat DIN rails and bus bars. The cut is clean and burr-free, there is no waste. The length stop with guiding device ensures that nothing slips during cutting and that the cut is always accurate to size.

DIN-RC 1 is suitable for cutting top hat DIN rails 35 x 7.5 mm and top hat DIN rails 35 x 15 mm.

DIN-RC 2 is suitable for cutting top hat DIN rails 35 x 7.5 mm, DIN rails 35 x 15 mm, DIN rails 15 x 5.5 mm and bus bars 10 x 3 mm.

Advantages & benefits

- Cuts the most common rails and bars
 - DIN-RC 1: DIN rails 35 x 7.5 mm and 35 x 15 mm
 - DIN-RC 2: DIN rails 35 x 7.5 mm, 35 x 15 mm and 15 x 5.5 mm as well as bus bars 10 x 3 mm
- Exact 90° cuts
- Burr-free cuts
- With length stop 1000 mm and guiding device

Type	Description	Order No.	PU
DIN-RC 1	Rail cutter for DIN rails with length stop 1000 mm	80189	1
DIN-RC 2	Rail cutter for DIN rails and bus bars with length stop 1000 mm	80190	1



DIN-RC 1



DIN-RC 2

DIN-RC 1:

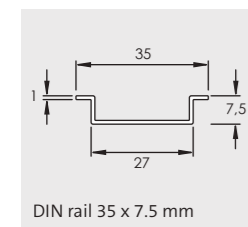

DIN rail 35 x 7.5 mm

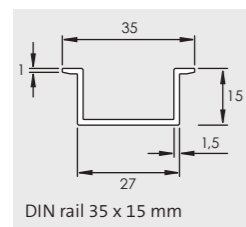

DIN rail 35 x 15 mm

DIN-RC 2 additionally:

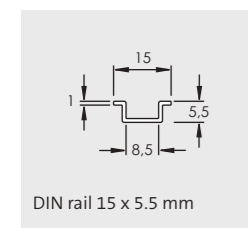

DIN rail 15 x 5.5 mm

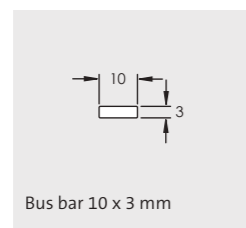

Bus bar 10 x 3 mm

Punch driver sets

Hand hydraulic punch driver and metric punches, Hydraulic foot pump



Type	Scope of delivery	Order No.	PU
Punch driver set BASIC	1 hand hydraulic punch driver (weight: 2 kg) 1 draw stud for punches (steel) ϕ 9.5 mm (3/8" UNF) to ϕ 19 mm (3/4" UNF), L: 105 mm 1 draw stud ϕ 19 mm (3/4" UNF), L: 125 mm 1 spacer 1 tube lubricant 1 HSS co pilot drill (multi step drill) 1 robust plastic storage case	80000	1
Punch driver set PRO 16-32	1 hand hydraulic punch driver (weight: 2 kg) 1 draw stud for punches (steel) ϕ 9.5 mm (3/8" UNF) to ϕ 19 mm (3/4" UNF), L: 105 mm 1 draw stud ϕ 19 mm (3/4" UNF), L: 125 mm 1 spacer 1 tube lubricant 1 HSS co pilot drill (multi step drill) 1 each knockout punch for steel M16 M20 M25 M32 1 robust plastic storage case	80005	1
Punch driver set PRO 16-63	1 hand hydraulic punch driver (weight: 2 kg) 1 draw stud for punches (steel) ϕ 9.5 mm (3/8" UNF) to ϕ 19 mm (3/4" UNF), L: 105 mm 1 draw stud ϕ 19 mm (3/4" UNF), L: 125 mm 1 spacer 1 tube lubricant 1 HSS co pilot drill (multi step drill) 1 each knockout punch for steel M16 M20 M25 M32 M40 M50 M63 1 robust plastic storage case	80006	1
Punch driver set LIGHT	1 hand hydraulic punch driver (weight: 2 kg) 1 draw stud for round punches for sheet steel, M16 M20 M25, ϕ 9.5 mm (3/8" UNF) to ϕ 19 mm (3/4" UNF), L: 105 mm 1 draw stud for round punches for sheet steel and stainless steel V2A, M32 M40 M50 M63 M85 ϕ 19 mm (3/4" UNF), L: 125 mm 1 spacer, 1 robust plastic storage case	80003	1

The compact, lightweight hand hydraulic punch driver makes it easy to punch holes into stainless V2A steel, mild steel, aluminium or plastics with a max. sheet thickness of 3 mm (V2A: 2 mm), due to its high hydraulic force. The cylinder of the punch driver rotates 360° on 3 axles, so maximum flexibility even in hard-to-reach places is provided.

The punch driver can be used with all icotek punches and also with punches of other manufacturers.

Advantages & benefits

- Maximum flexibility due to 360° head rotation
- High hydraulic force (60 kN, 600 bar) for easy punching
- Compact, lightweight aluminium design (2 kg)
- Fast and easy operation
- Punch driver also suitable for punches by other manufacturers

Specifications

Material	Aluminium
Punching force	60 kN
Operating pressure	600 bar

Accessories

Round punches	320 - 321
Rectangular & square punches	318

Hydraulic foot pump with hydraulic cylinder and accessories

Universally applicable single-stage foot pump with a fixed operating pressure of 450 bar and built-in pressure relief valve. Suitable for all icotek round punches, rectangular and square punches. Keeps your hands free to position the sheet metal punch precisely, especially when using larger sheet metal punches.

Type	Scope of delivery	Order No.	PU
Hydraulic foot pump	1 foot pump 2,5 m high pressure hose including quick coupling 1 hydraulic cylinder for holding round and rectangular punch 1 draw stud for rectangular punch, Order No. 80209 1 draw stud for round punch (steel) M16 – M25, Order No. 80200 1 multi-step drill, Order No. 80204 1 spacer, Order No. 80202 1 tube lubricant, Order No. 80203 Note: storage case not included in delivery	80002	1

Rectangular & square punches

sized for heavy multi-pin industrial connectors and icotek cable entry systems for steel and aluminium



Rectangular and square punches and dies make it easy to punch holes into mild steel, aluminium or plastics with a max. sheet thickness of 2 mm. Available for cut-outs for the most common sizes of heavy industrial connectors and also for numerous special cut-outs. Therefore, the punches are suitable for most icotek cable entry systems. Centre punches are integrated in the die for exact drilling of mounting holes.

The punches are for hydraulic operation only.

Advantages & benefits

- Centre punches for exact drilling of mounting holes
- Robust plastic storage case
- Suitable for hand hydraulic punch driver by icotek and other manufacturers

Specifications

Material Steel, hardened and burnished

Scope of delivery

Punch, die, counter nut and draw stud, robust plastic storage case

Compatible with

Hydraulic punch driver 317

Type	Cut-out size	Max. sheet thickness	For cut-out of connector	With centre punch (number)	Order No.	PU
Punches for steel and aluminium						
Punch 22x45	22 x 45 mm	2 mm	–	–	80059	1
Punch 68x68 **	68 x 68 mm	2 mm	–	–	80064	1
Punch 92x92 **	92 x 92 mm	2 mm	–	–	80060	1
Punch 125x125 * **	125 x 125 mm	2 mm	–	–	80063	1
NEW Punch E1	21 x 27 mm	2 mm	–	–	80075	1
Punch E2	24 x 43 mm	2 mm	–	2	80055	1
Punch E3	24 x 65mm	2 mm	–	2	80056	1
Punch E4	24 x 86mm	2 mm	–	2	80057	1
Punch E5	24 x 112mm	2 mm	–	2	80058	1
Punch 6	36 x 52 mm	2 mm	6-pin	4	80062	1
Punch B	46 x 46 mm	2 mm	–	4	80049 80050	1
Punch 10	36 x 65 mm	2 mm	10-pin	4	80051	1
Punch 16	36 x 86 mm	2 mm	16-pin	4	80052	1
Punch 24	36 x 112 mm	2 mm	24-pin	4	80053	1
Punch 24-XL	46 x 112 mm	2 mm	24-pin	4	80054	1
Punch 24-E * **	66 x 112 mm	2 mm	32-pin	–	80061	1
Centre punch for rectangular and square punches	–	–	–	–	80065	1
NEW Draw stud	for rectangular and square punches D = 19 mm, L = 135 mm				80209	1
NEW Draw stud	for rectangular and square punches, one side flattened D = 13 mm, d = 11 mm, L = 105 mm				80205	1
Draw stud	for square punch, two sides flattened Order No. 80063				80213	1

* Storage case not included in delivery
** Only to be used with hydraulic foot pump (order no. 80002).

Rectangular & square punches sized for heavy multi-pin industrial connectors and icotek cable entry systems for stainless steel

Type	Cut-out size	Max. sheet thickness	For cut-out of connector	With centre punch (number)	Order No.	PU
Punches for stainless steel V2A						
Punch 6 for stainless steel V2A	36 x 52 mm	2 mm	6-pin	–	80149	1
Punch B for stainless steel V2A	46 x 46 mm	2 mm	–	–	80150	1
Punch 10 for stainless steel V2A	36 x 65 mm	2 mm	10-pin	4	80151	1
Punch 16 for stainless steel V2A	36 x 86 mm	2 mm	16-pin	4	80152	1
Punch 24 for stainless steel V2A	36 x 112 mm	2 mm	24-pin	4	80153	1
Punch 24-XL for stainless steel V2A	46 x 112 mm	2 mm	24-pin	4	80154	1
Centre punch for rectangular and square punches	–	–	–	–	80065	1

Rectangular and square punches and dies make it easy to punch holes into stainless steel (V2A versions) with a max. sheet thickness of 2 mm. Available for cut-outs for the most common sizes of heavy industrial connectors and also for numerous special cut-outs. Therefore, the punches are suitable for most icotek cable entry systems. Centre punches are integrated in the die for exact drilling of mounting holes.

The punches are for hydraulic operation only.

Advantages & benefits

- Centre punches for exact drilling of mounting holes
- Robust plastic storage case
- Suitable for hand hydraulic punch driver by icotek and other manufacturers

Specifications

Material Steel, hardened and burnished

Scope of delivery

Punch, die, counter nut and draw stud, robust plastic storage case

Compatible with

Hydraulic punch driver 317

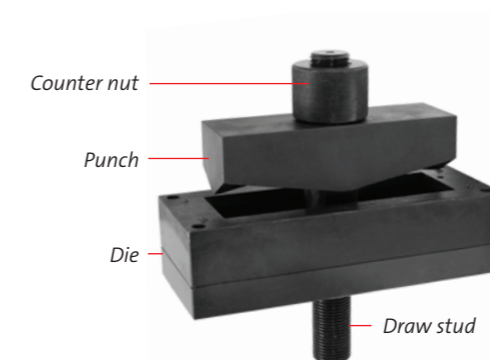

Round punches

for steel and aluminium,
for cut-outs PG & M16 – M85



3-fold slug splitting

Punch set M16 – M63
Order No. 80007

Self-centering knockout punches for mild steel, aluminium and plastic walls. Punches available for cut-outs PG 16, M16, M20, M25, M32, M40, M50, M63, M75 and M85. Cut-outs for icotek split cable glands and round cable entry plates can be punched.

The special cutting geometry of the punch reduces the cutting pressure and therefore the required effort. The punch splits slugs into several pieces (type related)* for easy slug removal. For installation of round switches icotek offers a PG 16 punch with an integrated 3 mm twist protection notch.

The punches are designed for manual and hydraulic operation.

Advantages & benefits

- Multiple splitting punches for easier slug removal/for easy punching
- Suitable with hand hydraulic punch driver by icotek or other manufacturers

Specifications

Material Steel, hardened and burnished

Scope of delivery

Punch and die (without draw stud)

Compatible with

Hydraulic punch driver 317

Type	Cut-out diameter	Max. sheet thickness	Thread Ø	Order No.	PU
Punches for steel and aluminium					
Punch set M16 – M63	16.2 – 63.5 mm	M16 – M25: 2.0 mm M32 – M63: 3.0 mm	9.5 mm/19 mm	80007	1
Punch M16	16.2 mm	2 mm	9.5 mm	80020	1
Punch M20	20.4 mm	2 mm	9.5 mm	80021	1
Punch M25	25.4 mm	2 mm	9.5 mm	80022	1
Punch M32	32.5 mm	3 mm	19 mm	80023	1
Punch M40	40.5 mm	3 mm	19 mm	80024	1
Punch M50	50.5 mm	3 mm	19 mm	80025	1
Punch M63	63.5 mm	3 mm	19 mm	80026	1
Punch M75	75.5 mm	2.5 mm	19 mm	80029	1
Punch M80	80 mm	2.5 mm	19 mm	80034	1
Punch M85	86 mm	2 mm	19 mm	80030	1
Punch PG 16	22.5 mm	3 mm	9.5 mm	80027	1
Punch PG 16 with twist protection notch	22.5 mm + 3 mm notch	3 mm	9.5 mm	80028	1
Draw stud	for punches M16 – M25, Ø 9.5 mm to Ø 19 mm, L: 105 mm			80200	1
Draw stud	for punches M32 – M85, Ø 19 mm, L: 125 mm			80201	1
Special nut	for the use with the hydraulic foot pump Order No. 80002			80214	1

Note: More PG sizes are available on request.

Round punches
for stainless steel,
for cut-outs PG & M16 – M85



2-fold slug splitting

Type	Cut-out diameter	Max. sheet thickness	Thread Ø	Order No.	PU
Punches for V2A stainless steel					
Punch set M16 – M63 round for stainless steel V2A	16.2 – 63.5 mm	2 mm	11.1 mm/19 mm	80070	1
Punch M16** for stainless steel V2A	16.2 mm	2 mm	11.1 mm	80120	1
Punch M20** for stainless steel V2A	20.4 mm	2 mm	11.1 mm	80121	1
Punch M25** for stainless steel V2A	25.4 mm	2 mm	11.1 mm	80122	1
Punch M32 for stainless steel V2A	32.5 mm	2 mm	19 mm	80123	1
Punch M40 for stainless steel V2A	40.5 mm	2 mm	19 mm	80124	1
Punch M50 for stainless steel V2A	50.5 mm	2 mm	19 mm	80125	1
Punch M63 for stainless steel V2A	63.5 mm	2 mm	19 mm	80126	1
Punch PG 16 with twist protection notch, for stainless steel V2A	22.5 mm + 3 mm notch	2 mm	9.5 mm	80128	1
Draw stud	with adapter 11.1 x 19.0 mm for V2A punches M16 - M25			80210	1

Self-centering knockout punches for stainless steel (V2A versions). Punches available for cut-outs PG 16, M16, M20, M25, M32, M40, M50, M63, M75 and M85. Cut-outs for icotek split cable glands and round cable entry plates can be punched.

The special cutting geometry of the punch reduces the cutting pressure and therefore the required effort. The punch splits slugs into two pieces for easy slug removal. For installation of round switches icotek offers a PG 16 punch with an integrated 3 mm twist protection notch.

The punches are designed for manual and hydraulic operation.

Advantages & benefits

- Multiple splitting punches for easier slug removal/for easy punching
- Suitable with hand hydraulic punch driver by icotek or other manufacturers

Specifications

Material Steel, hardened and burnished

Scope of delivery

Punch and die (without draw stud)

Compatible with

Hydraulic punch driver 317

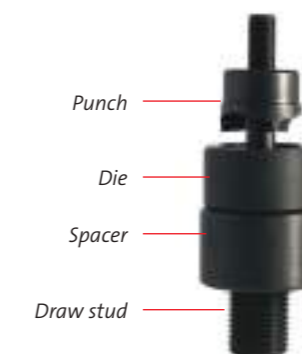

**Draw stud (Order No. 80210) is required.
Note: More PG sizes are available on request.

Punches CONFIX

for CONFIX cable conduit system and KEL-FW cable entry, for steel, aluminium, stainless steel



These punches can be used to punch the special cut-out shapes for the CONFIX bulkhead fittings.

In addition, the 80099 and 80199 punches can be used to punch the cut-outs for the KEL-FW cable entry.

For max. 2 mm stainless steel (V2A versions), sheet steel, aluminium and plastic.

The punches are suitable for the hand hydraulic punch driver and the hydraulic foot pump.

The punches are supplied with draw stud and counter nut in a transport case.

Advantages

- For the special cut-out shapes for CONFIX and KEL-FW
- High-quality padded transport case
- Suitable with hand hydraulic punch driver by icotek or other manufacturers

Specifications

Material Steel, hardened and burnished

Compatible with

Hydraulic punch driver 317
Hydraulic foot pump 317

Type	Cut-out size	Max. sheet thickness	Suitable for	With centre punch (number)	Order No.	PU
Punches for steel and aluminium						
Punch	22,6 x 22 mm	2 mm	FWS-A 16 FWS-A 20 FWS-B 11 FWS-B 16	4	80095	1
Punch	28 x 37 mm	2 mm	FWS-A 25 FWS-B 21	4	80096	1
Punch	40 x 64,5 mm	2 mm	FWS-A 32 FWS-B 29	4	80097	1
Punch	48,4 x 79,5 mm	2 mm	FWS-A 40 FWS-B 36	4	80098	1
Punch	83,25 x 60,5 mm	2 mm	FWS-A 50 FWS-B 48 KEL-FW B1 KEL-FW B4	4	80099	1
Punches for stainless steel V2A						
Punch	22,6 x 22 mm	2 mm	FWS-A 16 FWS-A 20 FWS-B 11 FWS-B 16	4	80195	1
Punch	28 x 37 mm	2 mm	FWS-A 25 FWS-B 21	4	80196	1
Punch	40 x 64,5 mm	2 mm	FWS-A 32 FWS-B 29	4	80197	1
Punch	48,4 x 79,5 mm	2 mm	FWS-A 40 FWS-B 36	4	80198	1
Punch	83,25 x 60,5 mm	2 mm	FWS-A 50 FWS-B 48 KEL-FW B1 KEL-FW B4	4	80199	1

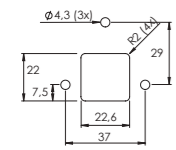

80095, 80195

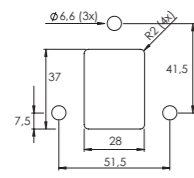

80096, 80196

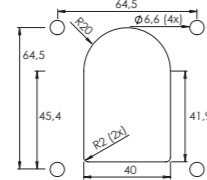

80097, 80197

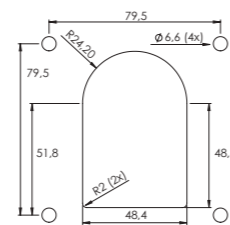

80098, 80198

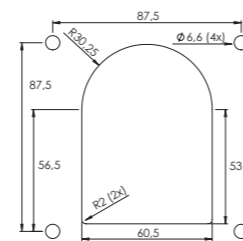

80099, 80199

Useful Tools

for measuring and mounting



KMS

Cable template

The correct size of the KT grommets can easily be determined by using the cable template

- Determining the diameter of the cable using the cable template
- Selecting the KT grommets according to the data on the cable template

Order No. 39800 | PU: 1



QVT-CLICK Tool

Mounting tool

The QVT-CLICK Tool for a quick and easy mounting of the split cable glands QVT-CLICK (see page 91)

Order No. 61435 | PU: 1



Wrenches

for plastic locknuts M75/M85

For mounting the KEL-DPF sizes we offer suitable wrenches with widths for M75 and M85 plastic locknuts.

Material: aluminium

M75: Order No.61436 | M85: Order No. 61437 | PU: 1



STFZ I/O Insert Tool

Mounting tool for I/O modules

STFZ I/O Insert Tool for a quick and easy mounting of STFZ terminal clamps (EMC shield clamps for peripheral modules, see page 211).

Order No. 61430 | PU: 1

9 Cable entry systems

with IFPS fire penetration seals acc. to EN 45545-3



Fire resistance of fire barriers

The European railway standard for fire safety EN 45545-3 regulates the fire resistance of fire barriers. The requirements and measures defined in this part of the standard aim to protect passengers and staff in railway vehicles against onboard fire incidents.

Fire barriers can have different standards

The lowest standard „E“

Barrier against flames, preventing fissure formation. „E45“, for example, means that the specimen can withstand the test for 45 minutes.

The highest standard „EI“

Barrier against flames, preventing fissure formation and thermal insulation, which means that the temperature on the side facing away from the fire must not exceed 200° C (180° K above room temperature). „EI30“, for example, means that the specimen can withstand the test for 30 minutes.

Based on the standards EN 45545-3 and EN 1363-1 icotek cable entry systems have been tested on „E“ and „EI“ in vertical alignment using mounted IFPS fire penetration seals. All tested products have been successfully certified using only one layer of fire penetration seals.

icotek cable entry systems meet the classifications E45 and EI30!

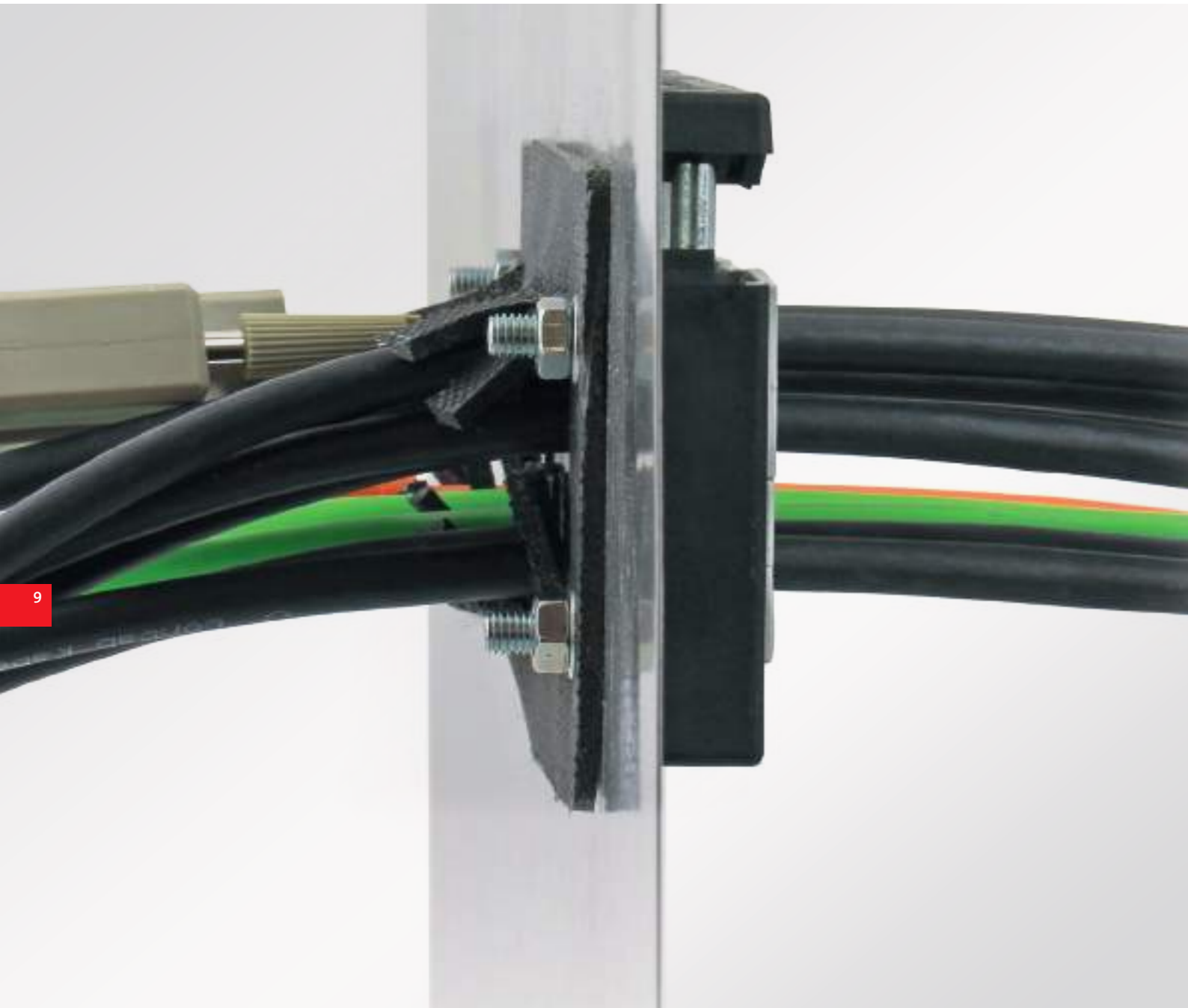

Fire penetration seals facing the fire side

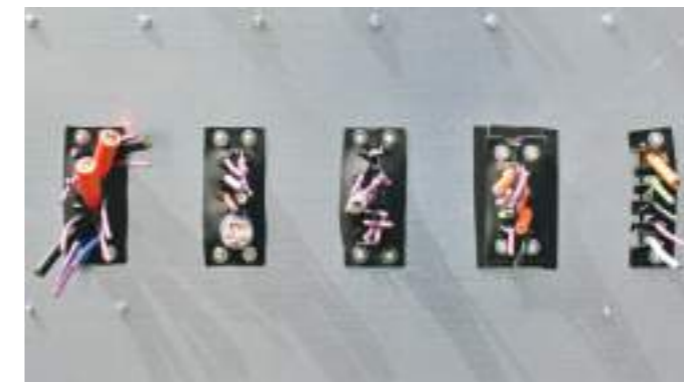

before



after

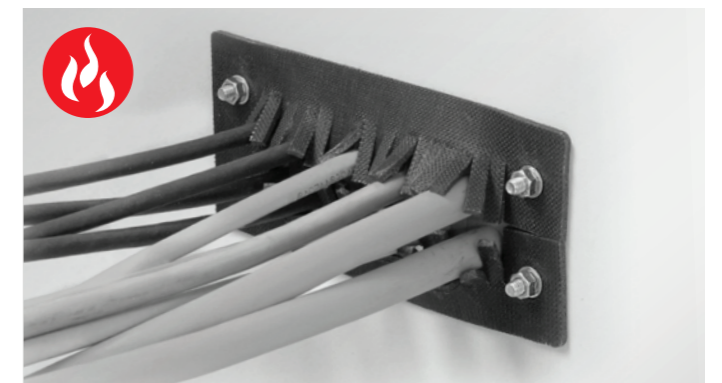

*4X for indoor use only

Cable entry systems with IFPS fire penetration seals according to EN 45545-3

E45 E130



icotek cable entry frames and plates with fire penetration seals, approved for use in railway technology (meeting the standards EN 45545-2, EN 45545-3 and EN 1363-1).

The intumescent (foaming) IFPS fire penetration seals which are mounted at the backside of the cable entry components consist of expandable graphite and increase their volume by a multiple in case of a fire.

This creates a barrier which prevents a penetration of flames and high heat from one room into another for the longest possible period.

Advantages & benefits

- Approved for use in railway technology (EN 45545-2, EN 45545-3 and EN 1363-1)
- Easy assembly
- High cable density
- Only one fire penetration seal per cable entry component required
- Large product variety
- Ingress protection up to IP66/UL Type 4X
- High classifications E45/EI30

Specifications

Cable entry comp. See standard products
 Fire penetration seal Intumescent (foaming)
 Material Graphite (C)

Scope of delivery

Each 1 cable entry frame/plate + suitable fire penetration seal.

Suitable grommets are not included in the shipment and have to be ordered separately.

Type	Order No.	Order No. with V2A screws	Cut-out	Grommets KT small large	IP Ingress protection	PU
KEL-U 24 4-BS	99300.001	99300.201	36 × 112 mm	2 2	IP54	5
KEL-U 24 7-BS	99300.002	99300.202	36 × 112 mm	6 1	IP54	5
KEL-U 24 10-BS	99300.003	99300.203	36 × 112 mm	10 -	IP54	5
KEL-U 16 2-BS	99301.001	99301.201	36 × 86 mm	- 2	IP54	5
KEL-U 16 5-BS	99301.002	99301.202	36 × 86 mm	4 1	IP54	5
KEL-U 16 8-BS	99301.003	99301.203	36 × 86 mm	8 -	IP54	5
KEL-U 10 6-BS	99306.001	99306.201	36 × 65 mm	6 -	IP54	5
KEL-U 10 3-BS	99306.002	99306.202	36 × 65 mm	2 1	IP54	5
KEL-U-B1-BS	99305.001	99305.201	46 × 46 mm	- 1	IP54	5
KEL-U-B4-BS	99305.002	99305.202	46 × 46 mm	4 -	IP54	5
KEL-ER 24 4-BS	99300.004	99300.204	36 × 112 mm	2 2	IP65 / IP66	5
KEL-ER 24 7-BS	99300.005	99300.205	36 × 112 mm	6 1	IP65 / IP66	5
KEL-ER 24 10-BS	99300.006	99300.206	36 × 112 mm	10 -	IP65 / IP66	5
KEL-ER 16 2-BS	99301.004	99301.204	36 × 86 mm	- 2	IP65 / IP66	5
KEL-ER 16 5-BS	99301.005	99301.205	36 × 86 mm	4 1	IP65 / IP66	5
KEL-ER 16 8-BS	99301.006	99301.206	36 × 86 mm	8 -	IP65 / IP66	5
KEL-ER 10 6-BS	99306.003	99306.203	36 × 65 mm	6 -	IP65 / IP66	5
KEL-ER 10 3-BS	99306.004	99306.204	36 × 65 mm	2 1	IP65 / IP66	5
KEL-ER B1-BS	99305.003	99305.203	46 × 46 mm	- 1	IP65 / IP66	5
KEL-ER B4-BS	99305.004	99305.204	46 × 46 mm	4 -	IP65 / IP66	5
KEL-E5-BS	99302.001	99302.201	24 × 112 mm	5 -	IP54	5
KEL-E4-BS	99309.001	99309.201	24 × 86 mm	4 -	IP54	5
KEL-E3-BS	99308.001	99308.201	24 × 65 mm	3 -	IP54	5
KEL-E2-BS	99307.001	99307.201	24 × 43 mm	2 -	IP54	5
KEL-ER-E5-BS	99302.002	99302.202	24 × 112 mm	5 -	IP65 / IP66	5
KEL-ER-E4-BS	99309.002	99309.202	24 × 86 mm	4 -	IP65 / IP66	5
KEL-ER-E3-BS	99308.002	99308.202	24 × 65 mm	3 -	IP65 / IP66	5
KEL-ER-E2-BS	99307.002	99307.202	24 × 43 mm	2 -	IP65 / IP66	5

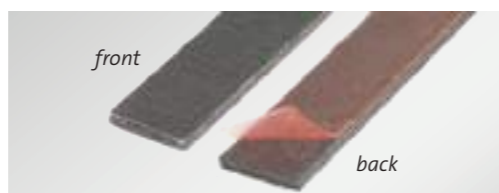

Also available: IFPS fire penetration seal stripe, 900 x 17 x 2.7 mm, self-adhesive
 Order No. 99303

E45 E130

Cable entry systems with IFPS fire penetration seals according to EN 45545-3

icotek cable entry frames and plates with fire penetration seals, approved for use in railway technology (meeting the standards EN 45545-2, EN 45545-3 and EN 1363-1).

The intumescent (foaming) IFPS fire penetration seals which are mounted at the backside of the cable entry components consist of expandable graphite and increase their volume by a multiple in case of a fire.

This creates a barrier which prevents a penetration of flames and high heat from one room into another for the longest possible period.

Advantages & benefits

- Approved for use in railway technology (EN 45545-2, EN 45545-3 and EN 1363-1)
- Easy assembly
- High cable density
- Only one fire penetration seal per cable entry component required
- Large product variety
- Ingress protection up to IP66 / UL Type 4X
- High classifications E45 / EI30

Specifications

Cable entry comp. See standard products
 Fire penetration seal Intumescent (foaming)
 Material Graphite (C)

Scope of delivery

Each 1 cable entry frame/plate + suitable fire penetration seal.

Suitable grommets are not included in the shipment and have to be ordered separately.

Type	Order No.	Cut-out	IP Ingress protection	PU
KEL-DPU 24 13-BS gy	99300.010	36 × 112 mm	IP66 / IP68	5
KEL-DPU 24 14-BS gy	99300.011	36 × 112 mm	IP66 / IP68	5
KEL-DPU 24 16-BS gy	99300.012	36 × 112 mm	IP66 / IP68	5
KEL-DPU 24 16-1-BS gy	99300.013	36 × 112 mm	IP66 / IP68	5
KEL-DPU 24 17-BS gy	99300.014	36 × 112 mm	IP66 / IP68	5
KEL-DPU 24 20-BS gy	99300.015	36 × 112 mm	IP66 / IP68	5
KEL-DPU 24 21-BS gy	99300.016	36 × 112 mm	IP66 / IP68	5
KEL-DPU 24 32-BS gy	99300.017	36 × 112 mm	IP66 / IP68	5
KEL-DPZ 16 11-BS gy	99301.007	36 × 86 mm	IP65 / IP66	5
KEL-DPZ 16 14-BS gy	99301.008	36 × 86 mm	IP65 / IP66	5
KEL-DPZ 16 20-BS gy	99301.009	36 × 86 mm	IP65 / IP66	5
KEL-DPZ 16 25-BS gy	99301.010	36 × 86 mm	IP65 / IP66	5
KEL-DPZ 16 34-BS gy	99301.011	36 × 86 mm	IP65 / IP66	5
KEL-DPZ 24 14-BS gy	99300.018	36 × 112 mm	IP65 / IP66	5
KEL-DPZ 24 15-BS gy	99300.019	36 × 112 mm	IP65 / IP66	5
KEL-DPZ 24 16-BS gy	99300.020	36 × 112 mm	IP65 / IP66	5
KEL-DPZ 24 17-BS gy	99300.021	36 × 112 mm	IP65 / IP66	5
KEL-DPZ 24 25-BS gy	99300.022	36 × 112 mm	IP65 / IP66	5
KEL-DPZ 24 32-BS gy	99300.023	36 × 112 mm	IP65 / IP66	5
KEL-DPZ 24 42-BS gy	99300.024	36 × 112 mm	IP65 / IP66	5

Fire penetration seal (accessories)

Type	Order No.	Cut-out	PU
Fire penetration seal size 24	99300	36 × 112 mm	1
Fire penetration seal size 16	99301	36 × 86 mm	1
Fire penetration seal size 10	99306	36 × 65 mm	1
Fire penetration seal size B	99305	46 × 46 mm	1
Fire penetration seal size E5	99302	24 × 112 mm	1
Fire penetration seal size E4	99309	24 × 86 mm	1
Fire penetration seal size E3	99308	24 × 65 mm	1
Fire penetration seal size E2	99307	24 × 43 mm	1
Fire penetration seal size KEL 183 *	99311	180 x 80 mm	1
Fire penetration seal size 24-MT *	99312	82 x 112 mm	1
Fire penetration seal size 16-MT *	99314	82 x 86 mm	1
Fire penetration seal for KEL-DPZ-KX/KL72 *	99315	62 x 192 mm	1

* At the time of certification, these sizes were not yet part of our product portfolio.



Also available: IFPS fire penetration seal stripe, 900 x 17 x 2.7 mm, self-adhesive
 Order No. 99303

*4X for indoor use only

10 Cable entry systems for the use in cleanrooms



A cleanroom is a room that has an extremely low concentration of airborne particles. Airborne particles are all particles and substances that are suspended in the air and for the most part cannot be seen with the naked eye.

Such cleanrooms are needed wherever particles present in the ambient air would disrupt production. This is the case, for example, in medical technology, semiconductor production, microsystems technology, pharmaceuticals, aerospace technology or optics. Cleanrooms are also needed in medical research.

Cleanrooms are classified by classes according to ISO 14644-1 as per ISO 1 to 9. The individual cleanroom classes may only contain a certain number of particles of a specified size. The particle concentration is considered per m³ of air. ISO 1 contains the strictest specifications, for ISO 9 the lowest specifications.

In order to meet these strict requirements, materials specially researched or modified by icotek are required and used for the certified cleanroom products.

All icotek cable entry systems for the cleanroom tested and certified by the Fraunhofer IPA are suitable and certified for class 1 in accordance with ISO 14644-1.



For more information about products for the cleanroom, please contact us directly: pm@icotek.com

Cleanroom classes according to ISO 14644-1 and other regulations

Regulatory				Limiting values of each air cleanliness class for differing particle sizes and reference volumes (acc. to ISO 14644-1)											
ISO Class	ISO Class "in operation"	US Fed. Standard 209E*	ISO 14644-1	0.1 µm		0.2 µm		0.3 µm		0.5 µm		1.0 µm		5.0 µm	
				per m ³	per ccf	per m ³	per ccf	per m ³	per ccf	per m ³	per ccf	per m ³	per ccf	per m ³	per ccf
1			1	35	0.3										
2			2	350	3	34	1	35	0.3						
3		1	3	1,000	30	337	7	308	3	25	1				
4		10	4	12,400	350	325	80	306	3	25	1				
5	A	100	5	100,000	2,833	23,700	671	10,200	289	3,520	100	832	24	29	0.8
	B									3,520	100			20	0.6
	C									3,520	100			20	0.6
	D									3,520	100			29	0.8
6		1,000	6	1,000,000	28,329	237,000	6,710	100,000	2,890	35,200	997	8,320	235	293	8
										35,200	1,000			247	7
7	B	10,000	7							352,000	9,972	83,200	2,357	2,930	83
	C									352,000	9,972			2,930	82
	D									352,000	9,972			2,930	82
										353,000	10,000			2,470	70
8			8							3,520,000	98,716	832,000	23,560	29,300	830
										3,520,000	98,716			29,000	821
										3,530,000	100,000			24,700	700
9			9							35,200,000	997,167	8,320,000	235,694	293,000	8,300

Source: Fraunhofer IPA

Industries and cleanliness criteria

	Particle emission	Outgassing VOC / SVOC	Outgassing aromatics	Outgassing NH ₃	ESD	Cleanability (filiform test)	Chemical resistance	Biological resistance	Antibacterial activity	H ₂ O ₂ absorption/desorption	Hygienic Design
Semiconductor industry	++	++	+	+	++	+	+	+	0	0	0
Electronic	++	+	+	+	++	0	0	0	0	0	0
Display (e.g. mobile phone)	++	+	0	0	++	0	0	0	0	0	0
Battery technology	++	0	0	0	++	0	0	0	0	0	0
Microsystem technology	++	+	0	0	++	+	+	+	0	0	0
Optic	+	++	+	+	+	+	+	+	0	0	0
Photovoltaic	+	+	0	0	+	0	0	0	0	0	0
Aerospace	++	++	+	+	++	+	+	+	+	0	0
Pharmacy	++	0	0	0	+	++	++	++	++	++	++
Biototechnology	+	+	0	0	0	++	++	++	++	+	++
Medical technology	+	0	0	0	+	++	++	++	++	+	++
Food technology	+	0	0	0	0	++	++	++	++	+	++
Hospital	0	0	0	0	0	++	++	++	++ ¹⁾	+	++

++ mandatory | + recommended, but not mandatory | 0 generally not required but in individual cases recommended
Source: Fraunhofer IPA

¹⁾4X for indoor use only



Specially designed for the cleanroom

Not only the particle emissions are relevant but also the outgassing values VOC (Volatile Organic Compounds)/SVOC (Semivolatile Organic Compounds) of the products used in clean rooms. This applies in particular to the semiconductor, optics and aerospace industries.

In the ISO class, the air cleanliness classification works on the basis of the particulate concentration.

In the ISO-ACC class, air cleanliness works on the basis of chemical concentration. The chemical concentration can lead to a chemical contamination, which can have a damaging effect on the product or on the process.

Materials as well as cable entry systems are classified based on their chemical concentration.

ISO-ACCe Class (x) =
ISO-Air Cleanliness chemical concentration for equipment =
AMC Class Equipment

ISO-ACCm Class (x) =
ISO-Air Cleanliness chemical concentration for material =
AMC Class Material

The Fraunhofer IPA certified values that were in part no longer measurable in the ultra-trace range and thus excellent to very good values. The material-specific emission rate (= ISO-ACCm class) was determined. The smaller the ISO-ACCm class, the lower the material-specific emission rate.

The test certificates of the Fraunhofer IPA can be requested from icotek: pm@icotek.com



Cleaning

icotek recommends cleaning products installed in cleanrooms with a mixture of 70% isopropanol and 30% distilled water.









Explanation of article numbers

The products with article ending **.600** are tested and certified for particle emission for cleanroom class 1 according to ISO 14644-1. The materials used for these products have been tested and certified for outgassing according to VOC/SVOC (ISO 14644-8; ISO 16000-6,-9,-11,-25, VDI 2083 sheet 17).

The products with the article ending **.601** are tested and certified for particle emission for cleanroom class 1 according to ISO 14644-1.

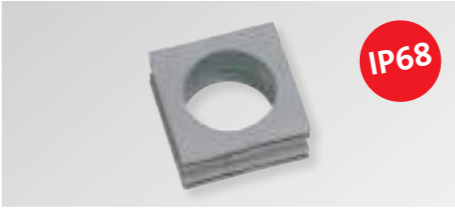
Chapter content

		
Split cable entry system for cables with connectors KEL-ER CR series 332	Split cable entry system for cables with connectors KEL-U CR series 333	Grommets small, single KT CR 334
		
Grommets small, multi KT CR 335	Grommets large KT CR 336	Cable entry plates KEL-DPZ CR series 337 – 339
		
Cable entry plates KEL-DPZ round CR series 340	Cable entry plates Hygienic Design Line KEL-DPZ-HD CR 341	

Cable entry frames KEL-ER CR series

Split cable entry system for cables with connectors.
Detailed product description from page 6.

Type	Cut-out mm	Grommets KT small large	Order No. *	Order No. **	PU
KEL-ER 24 CR					
KEL-ER 24 10 CR	36/46 × 112	10 –	48241.600	48241.601	5
KEL-ER 24 7 CR	36/46 × 112	6 1	48247.600	48247.601	5
KEL-ER 24 4 CR	36/46 × 112	2 2	48244.600	48244.601	5
KEL-ER 16 CR					
KEL-ER 16 8 CR	36/46 × 86	8 –	48168.600	48168.601	5
KEL-ER 16 5 CR	36/46 × 86	4 1	48165.600	48165.601	5
KEL-ER 16 2 CR	36/46 × 86	– 2	48162.600	48162.601	5
KEL-ER 10 CR					
KEL-ER 10 6 CR	36/46 × 65	6 –	48216.600	48216.601	5
KEL-ER 10 3 CR	36/46 × 65	2 1	48212.600	48212.601	5
KEL-ER-B CR					
KEL-ER-B4 CR	46 × 46	4 –	48204.600	48204.601	5
KEL-ER-B1 CR	46 × 46	– 1	48206.600	48206.601	5
KEL-ER-E CR					
KEL-ER-E5 CR	112 × 24	5 –	48250.600	48250.601	5
KEL-ER-E4 CR	112 × 24	4 –	48259.600	48259.601	5
KEL-ER-E3 CR	65 × 24	3 –	48258.600	48258.601	5
KEL-ER-E2 CR	43 × 24	2 –	48249.600	48249.601	5



- * The products with article ending .600 are tested and certified for particle emission for cleanroom class 1 according to ISO 14644-1. The materials used for these products have been tested and certified for outgassing according to VOC/SVOC (ISO 14644-8; ISO 16000-6,-9,-11,-25, VDI 2083 sheet 17).
- ** The products with the article ending .601 are tested and certified for particle emission for cleanroom class 1 according to ISO 14644-1.

*4X for indoor use only

Cable entry frames KEL-U CR series

Split cable entry system for cables with connectors.
Detailed product description from page 8.

Type	Cut-out mm	Grommets KT small large	Order No. *	Order No. **	PU
KEL-U 24 CR					
KEL-U 24 10 CR	36/46 × 112	10 –	54241.600	54241.601	5
KEL-U 24 7 CR	36/46 × 112	6 1	54247.600	54247.601	5
KEL-U 24 4 CR	36/46 × 112	2 2	54244.600	54244.601	5
KEL-U 16 CR					
KEL-U 16 8 CR	36/46 × 86	8 –	54168.600	54168.601	5
KEL-U 16 5 CR	36/46 × 86	4 1	54165.600	54165.601	5
KEL-U 16 2 CR	36/46 × 86	– 2	54162.600	54162.601	5
KEL-U 10 CR					
KEL-U 10 6 CR	36/46 × 65	6 –	54216.600	54216.601	5
KEL-U 10 3 CR	36/46 × 65	2 1	54212.600	54212.601	5
KEL-U-B CR					
KEL-U-B4 CR	46 × 46	4 –	54204.600	54204.601	5
KEL-U-B1 CR	46 × 46	– 1	54206.600	54206.601	5

- * The products with article ending .600 are tested and certified for particle emission for cleanroom class 1 according to ISO 14644-1. The materials used for these products have been tested and certified for outgassing according to VOC/SVOC (ISO 14644-8; ISO 16000-6,-9,-11,-25, VDI 2083 sheet 17).
- ** The products with the article ending .601 are tested and certified for particle emission for cleanroom class 1 according to ISO 14644-1.



333

KT CR
Grommets, small, single

Detailed product description from page 68.

Description	Type	Clamping range	Order No. * grey	Order No. ** grey	PU
BTK	BTK CR	Blank grommet	41251.600	41251.601	10
KT small	KT 1 CR	1 – 2 mm	39941.600	39941.601	10
	KT 2 CR	2 – 3 mm	39934.600	39934.601	10
	KT 3 CR	3 – 4 mm	41203.600	41203.601	10
	KT 4 CR	4 – 5 mm	41204.600	41204.601	10
	KT 5 CR	5 – 6 mm	41205.600	41205.601	10
	KT 6 CR	6 – 7 mm	41206.600	41206.601	10
	KT 7 CR	7 – 8 mm	41207.600	41207.601	10
	KT 8 CR	8 – 9 mm	41208.600	41208.601	10
	KT 9 CR	9 – 10 mm	41209.600	41209.601	10
	KT 10 CR	10 – 11 mm	41210.600	41210.601	10
	KT 11 CR	11 – 12 mm	41211.600	41211.601	10
	KT 12 CR	12 – 13 mm	41212.600	41212.601	10
	KT 13 CR	13 – 14 mm	41213.600	41213.601	10
	KT 14 CR	14 – 15 mm	41214.600	41214.601	10
	KT 15 CR	15 – 16 mm	41215.600	41215.601	10
	KTs 16 CR	16 mm	39901.600	39901.601	10
	KTs 17 CR	17 mm	39900.600	39900.601	10

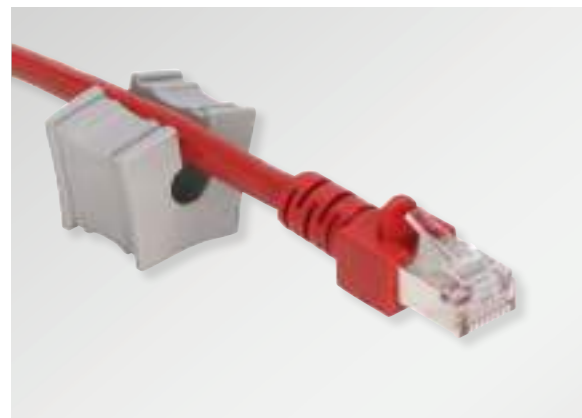

- * The products with article ending .600 are tested and certified for particle emission for cleanroom class 1 according to ISO 14644-1. The materials used for these products have been tested and certified for outgassing according to VOC/SVOC (ISO 14644-8; ISO 16000-6,-9,-11,-25, VDI 2083 sheet 17).
- ** The products with the article ending .601 are tested and certified for particle emission for cleanroom class 1 according to ISO 14644-1.

The cable grommets CR are each certified in connection with the cable entry frames KEL-ER CR and KEL-U CR.

*4X for indoor use only

KT CR
Grommets, small, multi

Detailed product description from page 72.

Description	Type	Clamping range	Order No. * grey	Order No. ** grey	PU
KT 2 x	KT 2 1 CR	2× ø 1 mm	39942.600	39942.601	10
	KT 2 2 CR	2× ø 2 mm	39935.600	39935.601	10
	KT 2 3 CR	2× ø 3 mm	39939.600	39939.601	10
	KT 2 4 CR	2× ø 4 mm	39906.600	39906.601	10
	KT 2 5 CR	2× ø 5 mm	41200.600	41200.601	10
	KT 2 6 CR	2× ø 6 mm	41201.600	41201.601	10
KT 4 x	KT 2 7 CR	2× ø 7 mm	41202.600	41202.601	10
	KT 2 8 CR	2× ø 8 mm	39917.600	39917.601	10
	KT 4 2 CR	4× ø 2 mm	39937.600	39937.601	10
	KT 4 3 CR	4× ø 3 mm	39914.600	39914.601	10
	KT 4 4 CR	4× ø 4 mm	39909.600	39909.601	10
	KT 4 5 CR	4× ø 5 mm	39908.600	39908.601	10
	KT 4 6 CR	4× ø 6 mm	39932.600	39932.601	10

- * The products with article ending .600 are tested and certified for particle emission for cleanroom class 1 according to ISO 14644-1. The materials used for these products have been tested and certified for outgassing according to VOC/SVOC (ISO 14644-8; ISO 16000-6,-9,-11,-25, VDI 2083 sheet 17).
- ** The products with the article ending .601 are tested and certified for particle emission for cleanroom class 1 according to ISO 14644-1.

The cable grommets CR are each certified in connection with the cable entry frames KEL-ER CR and KEL-U CR.



KT CR
Grommets, large

Cable entry plates
KEL-DPZ CR series

Detailed product description from page 69.

Detailed product description from page 131.

Description	Type	Clamping range	Order No. * grey	Order No. ** grey	PU
ATG	ATG CR	Adapter grommet	41253.600	41253.601	10
BTG	BTG CR	Blank grommet	41252.600	41252.601	10
KT large	KTG 13 CR	13 – 14 mm	41263.600	41263.601	10
	KTG 14 CR	14 – 15 mm	41264.600	41264.601	10
	KTG 15 CR	15 – 16 mm	41265.600	41265.601	10
	KT 16 CR	16 – 17 mm	41216.600	41216.601	10
	KT 17 CR	17 – 18 mm	41217.600	41217.601	10
	KT 18 CR	18 – 19 mm	41218.600	41218.601	10
	KT 19 CR	19 – 20 mm	41219.600	41219.601	10
	KT 20 CR	20 – 21 mm	41220.600	41220.601	10
	KT 21 CR	21 – 22 mm	41221.600	41221.601	10
	KT 22 CR	22 – 23 mm	41222.600	41222.601	10
	KT 23 CR	23 – 24 mm	41223.600	41223.601	10
	KT 24 CR	24 – 25 mm	41224.600	41224.601	10
	KT 25 CR	25 – 26 mm	41225.600	41225.601	10
	KT 26 CR	26 – 27 mm	41226.600	41226.601	10
	KT 27 CR	27 – 28 mm	41227.600	41227.601	10
	KT 28 CR	28 – 29 mm	41228.600	41228.601	10
	KT 29 CR	29 – 30 mm	41229.600	41229.601	10
	KT 30 CR	30 – 31 mm	41230.600	41230.601	10
	KT 31 CR	31 – 32 mm	41231.600	41231.601	10
	KT 32 CR	32 – 33 mm	41232.600	41232.601	10
	KT 33 CR	33 – 34 mm	41233.600	41233.601	10
	KT 34 CR	34 – 35 mm	41234.600	41234.601	10

Type	Cut-out mm	Number of cables	Order No. *	Order No. **	PU
KEL-DPZ 24 CR					
KEL-DPZ 24 14 CR	36 x 112 mm	10x 3.2 - 6.5 mm 4x 16 - 22 mm	43700.600 50700.600	43700.601 50700.601	5
KEL-DPZ 24 15 CR	36 x 112 mm	15x 7.2 - 12 mm	43720.600 50720.600	43720.601 50720.601	5
KEL-DPZ 24 16 CR	36 x 112 mm	8x 3.2 - 6.5 mm 4x 5 - 9.7 mm 2x 9 - 16.2 mm 2x 16 - 22 mm	43725.600 50725.600	43725.601 50725.601	5
KEL-DPZ 24 17 CR	36 x 112 mm	6x 3.2 - 6.5 mm 6x 5 - 10.2 mm 5x 9 - 16.2 mm	43705.600 50705.600	43705.601 50705.601	5
KEL-DPZ 24 25 CR	36 x 112 mm	12x 3.2 - 6.5 mm 7x 4.8 - 9.7 mm 6x 7.5 - 12 mm	43710.600 50710.600	43710.601 50710.601	5
KEL-DPZ 24 26 CR	36 x 112 mm	26x 5.0 - 10.2 mm	43711.600 50711.600	43711.601 50711.601	5
KEL-DPZ 24 32 CR	36 x 112 mm	21x 3.2 - 6.5 mm 8x 5 - 10.2 mm 3x 7.5 - 12 mm	43730.600 50730.600	43730.601 50730.601	5
KEL-DPZ 24 42 CR	36 x 112 mm	42x 3.2 - 6.5 mm	43715.600 50715.600	43715.601 50715.601	5
KEL-DPZ 24 121 CR	36 x 112 mm	119x 1.5 - 2.6 mm 2x 2.5 - 5 mm	43735.600 50735.600	43735.601 50735.601	5

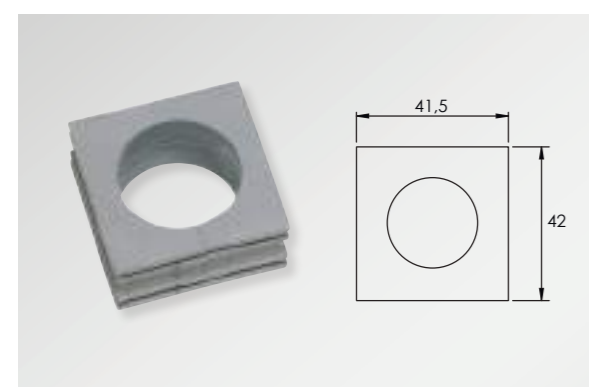

* The products with article ending .600 are tested and certified for particle emission for cleanroom class 1 according to ISO 14644-1. The materials used for these products have been tested and certified for outgassing according to VOC/SVOC (ISO 14644-8; ISO 16000-6,-9,-11,-25, VDI 2083 sheet 17).

** The products with the article ending .601 are tested and certified for particle emission for cleanroom class 1 according to ISO 14644-1.

The cable grommets CR are each certified in connection with the cable entry frames KEL-ER CR and KEL-U CR.

* The products with article ending .600 are tested and certified for particle emission for cleanroom class 1 according to ISO 14644-1. The materials used for these products have been tested and certified for outgassing according to VOC/SVOC (ISO 14644-8; ISO 16000-6,-9,-11,-25, VDI 2083 sheet 17).

** The products with the article ending .601 are tested and certified for particle emission for cleanroom class 1 according to ISO 14644-1.



Cable entry plates
KEL-DPZ CR series

Detailed product description from page 131.

Type	Cut-out mm	Number of cables	Order No. *	Order No. **	PU
KEL-DPZ 16 CR					
KEL-DPZ 16 11 CR	36 x 86 mm	11x 7.5 - 12 mm	43815.600	43815.601	5
KEL-DPZ 16 14 CR	36 x 86 mm	5x 3.2 - 6.5 mm 5x 5 - 10.2 mm 4x 9 - 16.2 mm	43816.600	43816.601	5
KEL-DPZ 16 20 CR	36 x 86 mm	11x 3.2 - 6.5 mm 5x 5 - 10.2 mm 4x 7.5 - 12 mm	43817.600	43817.601	5
KEL-DPZ 16 25 CR	36 x 86 mm	16x 3.2 - 6.5 mm 6x 5 - 10.2 mm 3x 7.5 - 12 mm	43818.600	43818.601	5
KEL-DPZ 16 34 CR	36 x 86 mm	34x 3.2 - 6.5 mm	43819.600	43819.601	5
KEL-DPZ 6 CR					
KEL-DPZ 6 12 CR	52 x 36 mm	12 x 4.5 - 8.0 mm	43809.600	43809.601	5
KEL-DPZ 6 18-1 CR	52 x 36 mm	6 x 2.5 - 5.0 mm 5 x 3.2 - 6.5 mm 7 x 4.5 - 8.0 mm	43811.600	43811.601	5
KEL-DPZ 6 18 CR	52 x 36 mm	18 x 3.2 - 6.5 mm	43812.600	43812.601	5
KEL-DPZ 6 23 CR	52 x 36 mm	13 x 2.5 - 5.0 mm 10 x 3.2 - 6.5 mm	43813.600	43813.601	5
KEL-DPZ 6 27 CR	52 x 36 mm	27 x 2.5 - 5.0 mm	43814.600	43814.601	5

Cable entry plates
KEL-DPZ CR series

Detailed product description from page 131.

Type	Cut-out mm	Number of cables	Order No. *	Order No. **	PU
KEL-DPZ-B CR					
KEL-DPZ-B 13 CR	46 x 46 mm	8x 3.2 - 6.5 mm 4x 5 - 10.2 mm 1x 16 - 22 mm	■ 43794.600 ■ 50794.600	■ 43794.601 ■ 50794.601	5
KEL-DPZ-B 17 CR	46 x 46 mm	10x 3.2 - 6.5 mm 4x 5 - 10.2 mm 2x 7.5 - 12 mm 1x 9 - 16.2 mm	■ 43796.600 ■ 50796.600	■ 43796.601 ■ 50796.601	5
KEL-DPZ-B 25 CR	46 x 46 mm	25x 3.2 - 6.5 mm	■ 43798.600 ■ 50798.600	■ 43798.601 ■ 50798.601	5
KEL-DPZ-E CR					
KEL-DPZ-E 112 7 CR	18 x 112 mm	7x 7.5 - 12 mm	■ 43780.600 ■ 50780.600	■ 43780.601 ■ 50780.601	5
KEL-DPZ-E 112 21 CR	18 x 112 mm	21x 3.2 - 6.5 mm	■ 43790.600 ■ 50790.600	■ 43790.601 ■ 50790.601	5
KEL-DPZ-KX/KL CR					
KEL-DPZ-KX/KL 72 CR	62 x 192 mm	42x 3.2 - 6.5 mm 21x 5 - 10.2 mm 6x 9 - 16.2 mm 3x 16 - 22 mm	■ 43675.001.600 ■ 43675.101.600	■ 43675.001.601 ■ 43675.101.601	1

* The products with article ending .600 are tested and certified for particle emission for cleanroom class 1 according to ISO 14644-1. The materials used for these products have been tested and certified for outgassing according to VOC/SVOC (ISO 14644-8; ISO 16000-6,-9,-11,-25, VDI 2083 sheet 17).
** The products with the article ending .601 are tested and certified for particle emission for cleanroom class 1 according to ISO 14644-1.

* The products with article ending .600 are tested and certified for particle emission for cleanroom class 1 according to ISO 14644-1. The materials used for these products have been tested and certified for outgassing according to VOC/SVOC (ISO 14644-8; ISO 16000-6,-9,-11,-25, VDI 2083 sheet 17).
** The products with the article ending .601 are tested and certified for particle emission for cleanroom class 1 according to ISO 14644-1.



Cable entry plates KEL-DPZ round CR series

Detailed product description from page 138.

Type	Number of cables	Thread metric	Thread length	External diameter	Mounting height	Order No. *	Order No. **	PU
KEL-DPZ 25 3 CR	2x 3.2 - 5.2 mm 1x 3.2 - 6.5 mm	M25 x 1.5	14 mm	39 mm	8 mm	43736.600 50736.600	43736.601 50736.601	5
KEL-DPZ 25 4 CR	4x 3.2 - 5.2 mm	M25 x 1.5	14 mm	39 mm	8 mm	43737.600 50737.600	43737.601 50737.601	5
KEL-DPZ 32 4 CR	3x 3.2 - 6.5 mm 1x 7.2 - 12.5 mm	M32 x 1.5	14 mm	44 mm	8 mm	43732.600 50732.600	43732.601 50732.601	5
KEL-DPZ 32 4-2 CR	4x 5 - 9.5 mm	M32 x 1.5	14 mm	44 mm	8 mm	43733.600 50733.600	43733.601 50733.601	5
KEL-DPZ 32 7 CR	7x 3.2 - 6.5 mm	M32 x 1.5	14 mm	44 mm	8 mm	43734.600 50734.600	43734.601 50734.601	5
KEL-DPZ 40 8 CR	4x 3.2 - 6.5 mm 4x 5 - 10.2 mm	M40 x 1.5	14 mm	52 mm	8 mm	43741.600 50741.600	43741.601 50741.601	5
KEL-DPZ 50 8 CR	5x 5 - 10.2 mm 3x 7.2 - 12.5 mm	M50 x 1.5	14 mm	62 mm	8 mm	43750.600 50750.600	43750.601 50750.601	5
KEL-DPZ 50 10 CR	7x 3.2 - 6.5 mm 2x 5 - 10.2 mm 1x 16 - 22.2 mm	M50 x 1.5	14 mm	62 mm	8 mm	43751.600 50751.600	43751.601 50751.601	5
KEL-DPZ 50 12 CR	4x 3.2 - 6.5 mm 8x 5 - 10.2 mm	M50 x 1.5	14 mm	62 mm	8 mm	43752.600 50752.600	43752.601 50752.601	5
KEL-DPZ 50 19 CR	19x 3.2 - 6.5 mm	M50 x 1.5	14 mm	62 mm	8 mm	43758.600 50758.600	43758.601 50758.601	5
KEL-DPZ 50 78 CR	76x 1.5 - 2.6 mm 2x 2.5 - 5 mm	M50 x 1.5	14 mm	62 mm	8 mm	43756.600 50756.600	43756.601 50756.601	5
KEL-DPZ 63 9 CR	1x 3.2 - 6.5 mm 3x 5 - 10.2 mm 4x 9 - 16.2 mm 1x 16 - 22.2 mm	M63 x 1.5	14 mm	75 mm	8 mm	43760.600 50760.600	43760.601 50760.601	5
KEL-DPZ 63 13 CR	4x 3.2 - 6.5 mm 4x 5 - 10.2 mm 5x 9 - 16.2 mm	M63 x 1.5	14 mm	75 mm	8 mm	43761.600 50761.600	43761.601 50761.601	5
KEL-DPZ 63 14 CR	14x 5 - 10.2 mm	M63 x 1.5	14 mm	75 mm	8 mm	43762.600 50762.600	43762.601 50762.601	5
KEL-DPZ 63 35 CR	35x 3.2 - 6.5 mm	M63 x 1.5	14 mm	75 mm	8 mm	43763.600 50763.600	43763.601 50763.601	5



* The products with article ending .600 are tested and certified for particle emission for cleanroom class 1 according to ISO 14644-1. The materials used for these products have been tested and certified for outgassing according to VOC/SVOC (ISO 14644-8; ISO 16000-6,-9,-11,-25, VDI 2083 sheet 17).
** The products with the article ending .601 are tested and certified for particle emission for cleanroom class 1 according to ISO 14644-1.

*4X for indoor use only | ** Only valid for grey product types

Cable entry plates KEL-DPZ-HD CR Hygienic Design Line

Detailed product description from page 353.

Type	Number of cables	Thread metric	Thread length	External diameter	Mounting height	Order No. *	Order No. **	PU
KEL-DPZ-HD 32 4 CR	3x 3.2 - 6.5 mm 1x 7.2 - 12.5 mm	M32 x 1.5	14 mm	44 mm	8 mm	70351.600	70351.601	5
KEL-DPZ-HD 32 4-2 CR	4x 5 - 9.5 mm	M32 x 1.5	14 mm	44 mm	8 mm	70352.600	70352.601	5
KEL-DPZ-HD 32 7 CR	7x 3.2 - 6.5 mm	M32 x 1.5	14 mm	44 mm	8 mm	70353.600	70353.601	5
KEL-DPZ-HD 40 8 CR	4x 3.2 - 6.5 mm 4x 5 - 10.2 mm	M40 x 1.5	14 mm	52 mm	8 mm	70354.600	70354.601	5
KEL-DPZ-HD 50 8 CR	5x 5 - 10.2 mm 3x 7.2 - 12.5 mm	M50 x 1.5	14 mm	62 mm	8 mm	70355.600	70355.601	5
KEL-DPZ-HD 50 10 CR	7x 3.2 - 6.5 mm 2x 5 - 10.2 mm 1x 16 - 22.2 mm	M50 x 1.5	14 mm	62 mm	8 mm	70356.600	70356.601	5
KEL-DPZ-HD 50 12 CR	4x 3.2 - 6.5 mm 8x 5 - 10.2 mm	M50 x 1.5	14 mm	62 mm	8 mm	70357.600	70357.601	5
KEL-DPZ-HD 50 19 CR	19x 3.2 - 6.5 mm	M50 x 1.5	14 mm	62 mm	8 mm	70358.600	70358.601	5
KEL-DPZ-HD 63 9 CR	1x 3.2 - 6.5 mm 3x 5 - 10.2 mm 4x 9 - 16.2 mm 1x 16 - 22.2 mm	M63 x 1.5	14 mm	75 mm	8 mm	70359.600	70359.601	5
KEL-DPZ-HD 63 13 CR	4x 3.2 - 6.5 mm 4x 5 - 10.2 mm 5x 9 - 16.2 mm	M63 x 1.5	14 mm	75 mm	8 mm	70360.600	70360.601	5
KEL-DPZ-HD 63 14 CR	14x 5 - 10.2 mm	M63 x 1.5	14 mm	75 mm	8 mm	70361.600	70361.601	5
KEL-DPZ-HD 63 35 CR	35x 3.2 - 6.5 mm	M63 x 1.5	14 mm	75 mm	8 mm	70362.600	70362.601	5

* The products with article ending .600 are tested and certified for particle emission for cleanroom class 1 according to ISO 14644-1. The materials used for these products have been tested and certified for outgassing according to VOC/SVOC (ISO 14644-8; ISO 16000-6,-9,-11,-25, VDI 2083 sheet 17).
** The products with the article ending .601 are tested and certified for particle emission for cleanroom class 1 according to ISO 14644-1.



341

11 Cable entry systems for the food industry



11.1 Cable entry frames for the food industry in signal colour blue

 <p>IP65</p> <p>NEW</p>	 <p>IP65</p> <p>NEW</p>
<p>Split cable entry frames for the food industry in signal colour blue with IP65 rated protection</p> <p>KEL-ER-BL series</p> <p>344 – 347</p>	<p>Cable grommets split for the food industry in signal colour blue with IP65 rated protection for cable diameters 1 – 35 mm</p> <p>KT-BL</p> <p>348 – 349</p>

- Split system
- Signal colour blue (similar to Signal Blue RAL 5005)
- Maintain warranty on pre-terminated cables
- Fast and easy assembly
- High cable density
- Most sizes are industrial standard cut-outs.
- IP65 rated protection due to a high clamping pressure on the cover lid and injected sealing
- Integrated strain relief according to EN 62444



11.2 Cable entry plates for the food industry – Hygienic Design Line

 <p>IP68</p>	 <p>IP68</p>	
<p>Cable entry plates screw-in or snap-in assembly, high strain relief</p> <p><i>Hygienic Design Line</i></p> <p>KEL-DPU-HD</p> <p>350 – 351</p>	<p>Cable entry plates, round with thread and locknut M32 – M63</p> <p><i>Hygienic Design Line</i></p> <p>KEL-DPZ-HD round</p> <p>352 – 353</p>	<p>Plugs for cable entry plates</p> <p><i>Hygienic Design Line</i></p> <p>ST-B-HD ST-B-HDD</p> <p>354</p>



Detectable cable ties and holders for cable ties

Hygienic Design Line

KB-HDD | KBH-HDD

355

- IP65 to IP68 rated protection, double cable sealing on front and back
- High cable density
- FDA compliant, food approval acc. to 1935/2004/EG and (EU) 10/2011, Ecolab certified
- Fast and easy assembly
- Very smooth surface
- Signal blue colour (similar to Signal Blue RAL 5005)
- Compact, space-saving design
- For metric cut-outs
- The fixation is very simple with the lock nut
- Flexible clamping range, up to 7 mm

Cable entry frames for the food industry in signal colour blue with IP65 rating
KEL-ER-BL series

The KEL-ER-BL in the signal colour blue is preferably used in the area of food packaging and processing machines where there is no direct contact with food. Products in this signal colour are also popular in the pharmaceutical sector.

The KEL-ER-BL is a split cable entry system for cables with and without connectors. Depending on the size, cables with a diameter of 1 to 16 mm (single grommets KT-BL 1 to KT-BL 15) or 16 to 35 mm (single grommets KT-BL 16 to 34) can be routed, sealed with IP65 and simultaneously strain-relieved according to DIN EN 62444. The cable grommets are automatically fixed into the frame during assembly. After complete fitting, the end cover is screwed on.

The KEL-ER frames match exactly the cut-out dimensions for 10-, 16- and 24-pin standard industrial connectors. Either a cut-out of 36 mm or 46 mm in height can be chosen depending on the cables being routed. The KEL-ER-B frame matches the cut-out dimensions of 46 x 46 mm measuring instruments.

The single-row cable entry KEL-ER-BL-E is characterised by its space-saving design and is therefore ideal for confined spaces and cables with flat connectors (e.g. Sub-D).

The KEL-ER-BL series is IP65 rated due to the injected seal and the use of single grommets. An additional blue flat rubber gasket is included in the shipment.

Advantages

- Maintain manufacturer's warranty on pre-terminated cables
- Retrofittings, repairs and maintenance can be done much more easily and quickly
- High cable density, wide variety of grommets
- Strain relief according to EN 62444
- High stability, vibration resistant
- Very simple assembly

Specifications

Material	Polyamide (PA)
Flame class	UL 94 V-0, self-extinguishing
IP rating	IP65, with gasket and correct selection of single grommets (certified acc. to EN 60529)
Colour	Blue (similar to Signal Blue RAL 5005)
Temperature	-40°C to +140°C (static)
Properties	Halogen-free, silicone-free
Frame depth	17 mm

Accessories

KT-BL Cable grommets	348 - 349
----------------------	-----------



KEL-ER-BL Cable entry frames in signal colour blue
KEL-ER-BL 24, KEL-ER-BL 16



IP65

Description	Cut-out Drilling template	Type	Cut-out mm	Grommets KT-BL small large	Order No.	PU
		KEL-ER-BL 24 10 with V2A screws	36/46 x 112	10 -	70000.200	10
		KEL-ER-BL 24 7 with V2A screws	36/46 x 112	6 1	70001.200	10
		KEL-ER-BL 24 4 with V2A screws	36/46 x 112	2 2	70002.200	10
		KEL-ER-BL 16 8 with V2A screws	36/46 x 86	8 -	70003.200	10
		KEL-ER-BL 16 5 with V2A screws	36/46 x 86	4 1	70004.200	10
		KEL-ER-BL 16 2 with V2A screws	36/46 x 86	- 2	70005.200	10

11.1

11.1

KEL-ER-BL
Cable entry frames
in signal colour blue
KEL-ER-BL 10, KEL-ER-BL-B

IP65



Description	Cut-out Drilling template	Type	Cut-out mm	Grommets KT-BL small large	Order No.	PU
		KEL-ER-BL 10 6 with V2A screws	36/46 x 65	6 -	70006.200	10
		KEL-ER-BL 10 3 with V2A screws	36/46 x 65	2 1	70007.200	10
		KEL-ER-BL B4 with V2A screws	46 x 46	4 -	70008.200	10
		KEL-ER-BL B1 with V2A screws	46 x 46	- 1	70009.200	10

KEL-ER-BL
Cable entry frames
in signal colour blue
KEL-ER-BL-E



IP65

Description	Cut-out Drilling template	Type	Cut-out mm	Grommets KT-BL small large	Order No.	PU
		KEL-ER-BL-E5 with V2A screws	112 x 24	5 -	70010.200	10
		KEL-ER-BL-E4 with V2A screws	112 x 24	4 -	70011.200	10
		KEL-ER-BL-E3 with V2A screws	65 x 24	3 -	70012.200	10
		KEL-ER-BL-E2 with V2A screws	43 x 24	2 -	70013.200	10

KT-BL

Split cable grommets for KEL-ER-BL for the food industry in signal colour blue small, single



The KT-BL range of grommets are particularly suitable for use with the KEL-ER-BL cable entry frames. The signal colour blue provides clear visual colour identification.

They are designed for cable diameters from 1 to 16 mm. Blank grommets can seal unused grommet locations.

When installing the small grommets in multiple rows, the flat sides should be facing each other. This allows the flat sides to match up and provide a secure seal.

Advantages

- Routing of cables with and without connectors through the cable entry frame KEL-ER-BL
- High protection class up to IP65
- High strain relief in accordance with EN 62444
- Available for a wide range of cable diameters
- Signal colour blue for a clear visual colour recognition in the food industry

Specification

Material	Elastomer
Flame class	UL 94 V-0, self-extinguishing
IP rating	up to IP65
Colour	Blue (similar to Signal blue RAL 5005)
Temperature	-40°C to +100°C (static)
Properties	Halogen-free, silicone-free

Suitable for

KEL-ER-BL series

Description	Type	Clamping range	Order No	PU
	KT-BL 1	1 – 2 mm	70101	10
	KT-BL 2	2 – 3 mm	70102	10
	KT-BL 3	3 – 4 mm	70103	10
	KT-BL 4	4 – 5 mm	70104	10
	KT-BL 5	5 – 6 mm	70105	10
	KT-BL 6	6 – 7 mm	70106	10
	KT-BL 7	7 – 8 mm	70107	10
	KT-BL 8	8 – 9 mm	70108	10
	KT-BL 9	9 – 10 mm	70109	10
	KT-BL 10	10 – 11 mm	70110	10
	KT-BL 11	11 – 12 mm	70111	10
	KT-BL 12	12 – 13 mm	70112	10
	KT-BL 13	13 – 14 mm	70113	10
	KT-BL 14	14 – 15 mm	70114	10
	KT-BL 15	15 – 16 mm	70115	10
	BTK-BL	Blank grommet	70135	10



KT-BL

Split cable grommets for KEL-ER-BL for the food industry in signal colour blue large, single

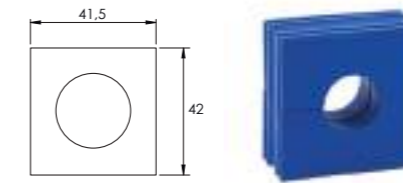

Description	Type	Clamping range	Order No	PU
	KT-BL 16	16 – 17 mm	70116	10
	KT-BL 17	17 – 18 mm	70117	10
	KT-BL 18	18 – 19 mm	70118	10
	KT-BL 19	19 – 20 mm	70119	10
	KT-BL 20	20 – 21 mm	70120	10
	KT-BL 21	21 – 22 mm	70121	10
	KT-BL 22	22 – 23 mm	70122	10
	KT-BL 23	23 – 24 mm	70123	10
	KT-BL 24	24 – 25 mm	70124	10
	KT-BL 25	25 – 26 mm	70125	10
	KT-BL 26	26 – 27 mm	70126	10
	KT-BL 27	27 – 28 mm	70127	10
	KT-BL 28	28 – 29 mm	70128	10
	KT-BL 29	29 – 30 mm	70129	10
	KT-BL 30	30 – 31 mm	70130	10
	KT-BL 31	31 – 32 mm	70131	10
	KT-BL 32	32 – 33 mm	70132	10
	KT-BL 33	33 – 34 mm	70133	10
	KT-BL 34	34 – 35 mm	70134	10
	BTG-BL	Blank grommet	70136	10

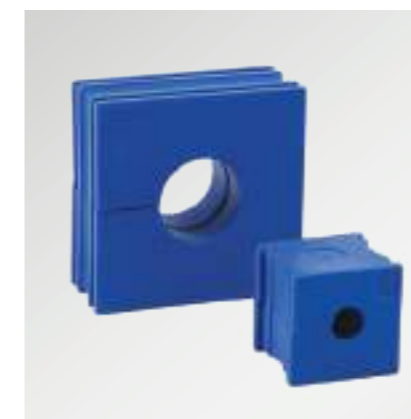

The KT-BL range of grommets are particularly suitable for use with the KEL-ER-BL cable entry frames. The signal colour blue provides clear visual colour identification.

They are designed for cable diameters from 16 to 35 mm.

Advantages

- Routing of cables with and without connectors through the cable entry frame KEL-ER-BL
- High protection class up to IP65
- High strain relief in accordance with EN 62444
- Available for a wide range of cable diameters
- Signal colour blue for a clear visual colour recognition in the food industry

Specifications

Material	Elastomer
Flame class	UL 94 V-0, self-extinguishing
IP rating	up to IP65
Colour	Blue (similar to Signal blue RAL 5005)
Temperature	-40°C to +100°C (static)
Properties	Halogen-free, silicone-free

Suitable for

KEL-ER-BL series

Heavy-duty cable entry plates
Hygienic Design Line
KEL-DPU-HD

The cable entry plates KEL-DPU-HD have been specially developed for installation in food processing and packaging machines. During the development according to the Hygienic Design guidelines, care was taken to ensure that the visible side of the cable entry plate are free of dirt-collecting recesses. The surface was kept very smooth. The outer contour has a radius of 6 mm instead of the required 3 mm. In addition, the KEL-DPU-HD uses an FDA-compliant elastomer in accordance with food approval 1935/2004/EG and (EU) 10/2011. The signal colour blue ensures a clear visual colour recognition.

KEL-DPU-HD entry plates are designed to route and seal cables without connectors (from 3.2 mm to 20.5 mm in diameter) in limited space with IP66/IP68**. The KEL-DPU-HD is particularly characterised by its solid robust frame and the increased strain relief of the routed cables.

The KEL-DPU-HD 24 matches exactly the cut-out dimensions of 24-pin standard industrial connectors. The cable entry plate is mounted either by screwing it to the inside of the enclosure or by snapping it into the cut-out.

Advantages & benefits

- Elastomer of the cable entry plate made of material according to 1935/2004/EG, (EU) 10/2011
- FDA compliant
- Developed according to hygienic design guidelines (EHEDG)
- Hygienic design – free of dirt-collecting recesses
- Very flat design, very smooth surface (Ra 0.421 µm)
- Dual sealing of cables (IP66/IP68**)
- High strength and stability
- High strain relief
- Fast and easy assembly
- Very high cable density
- Cable diameter 3.2 – 20.5 mm
- Reproducible cleaning process
- Very low moisture absorption
- High resistance to aromatic solvents, oils, greases, mineral products

Specifications

Material	Frame: Polypropylene (PP), sealing plate: Elastomer FDA compliant material Food approval acc. to 1935/2004/EG Food approval acc. to (EU) 10/2011
IP rating	IP65/IP66/IP67/IP68**
Flame class	UL 94 HB
Colour	Blue (similar to Signal blue RAL 5005)
Temperature	-40°C to +80°C
Properties	Halogen-free, silicone-free
For wall thickness	1.5 – 2 mm (snap-in mounting)

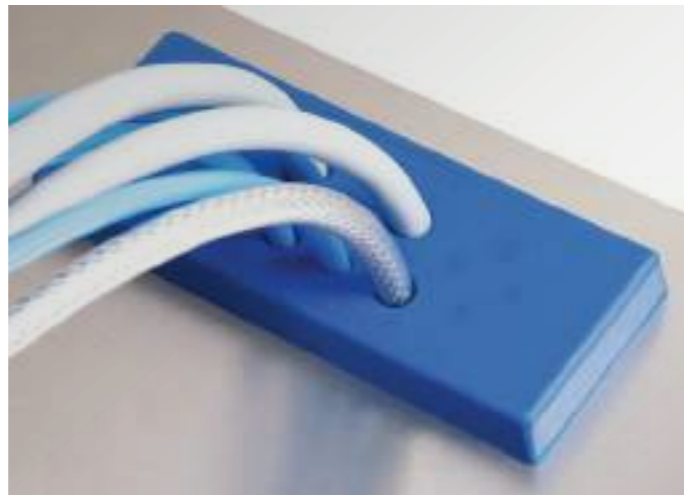

i Single-piece packaging units are available on request.

KEL-DPU-HD
Heavy-duty cable entry plates
with high strain relief
Hygienic Design Line



IP65 IP66 IP67 IP68

Description	Cut-out Drilling template	Type	Cut-out mm	Number of cables	Order No.	PU
		KEL-DPU-HD 24 13 with threaded bushings M4	36 x 112 mm	10x 3.2 – 6.3 mm 3x 16 – 20.5 mm	73940	10
		KEL-DPU-HD 24 14 with threaded bushings M4	36 x 112 mm	5x 3.2 – 6.3 mm 2x 4 – 7.5 mm 3x 5.5 – 10.5 mm 1x 8 – 12.5 mm 3x 12 – 16.2 mm	73944	10
		KEL-DPU-HD 24 16 with threaded bushings M4	36 x 112 mm	8x 3.2 – 5.5 mm 6x 5 – 8.5 mm 2x 9.5 – 14.5 mm	73936	10
		KEL-DPU-HD 24 16-1 with threaded bushings M4	36 x 112 mm	2x 3.2 – 6.3 mm 9x 4 – 7.5 mm 1x 5.5 – 10.5 mm 1x 8 – 12.5 mm 3x 12 – 16.2 mm	73932	10
		KEL-DPU-HD 24 17 with threaded bushings M4	36 x 112 mm	4x 3.2 – 6.3 mm 2x 4 – 7.5 mm 1x 5.5 – 10.5 mm 10x 8 – 12.5 mm	73934	10
		KEL-DPU-HD 24 20 with threaded bushings M4	36 x 112 mm	12x 3.2 – 5.5 mm 8x 5 – 10.5 mm	73938	10
		KEL-DPU-HD 24 21 with threaded bushings M4	36 x 112 mm	1x 3.2 – 6.3 mm 14x 4 – 7.5 mm 4x 5.5 – 10.5 mm 2x 8 – 12.5 mm	73930	10
		KEL-DPU-HD 24 32 with threaded bushings M4	36 x 112 mm	32x 3.2 – 6.3 mm	73942	10

** IP68 only when screw mounted

Cable entry plates
Hygienic Design Line
KEL-DPZ-HD

The cable entry plates KEL-DPZ-HD with metric thread from M32 to M63 have been developed for installation in food processing and packaging machines.

During the development according to the Hygienic Design guidelines, care was taken to ensure that the visible side of the cable entry plate are free of dirt-collecting recesses. The surface was kept very smooth. The outer contour has a radius of 6 mm instead of the required 3 mm. In addition, the KEL-DPZ-HD uses an FDA-compliant elastomer in accordance with food approval 1935/2004/EG and (EU) 10/2011. The signal colour blue ensures a clear visual colour recognition.

The cable entry plates are designed to route several cables and hoses with a diameter range of 3.2 mm and 22.2 mm and seal them acc. to IP65/66/67/68. A significant advantage over cable glands is the significantly higher cable density and the flexibility of the cable diameter range. The fixation is very simple with the lock nut. A lock nut is included in the shipment.

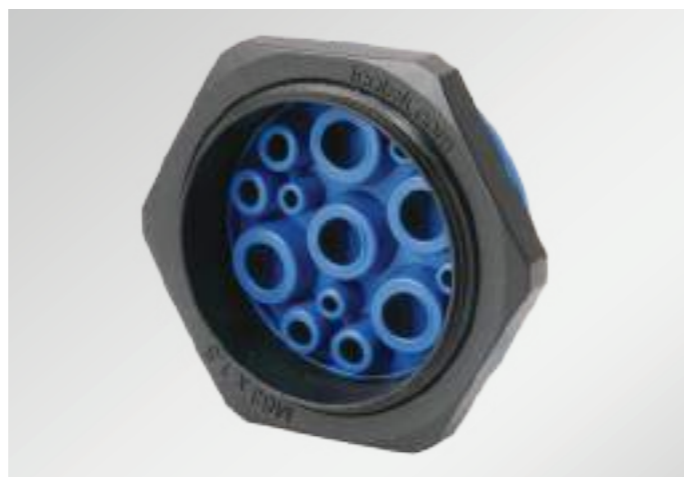
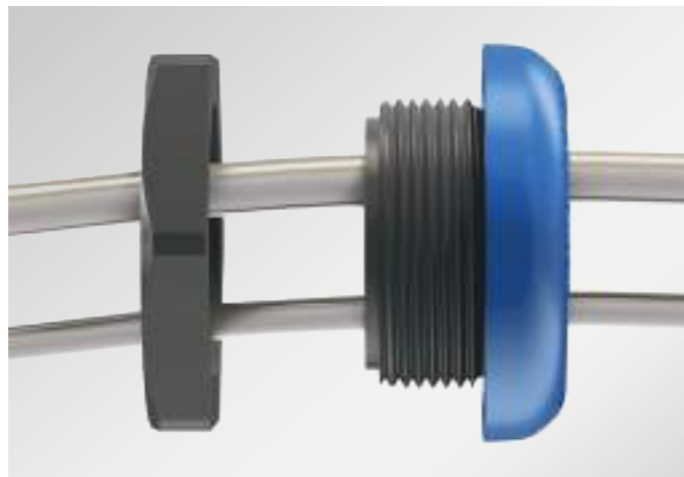

Advantages & benefits

- Elastomer of the cable entry plate made of material according to 1935/2004/EG, (EU) 10/2011
- FDA compliant
- Developed according to hygienic design guidelines (EHEDG)
- Hygienic design – free of dirt-collecting recesses
- Ecolab certified
- Very flat design
- Very smooth surface (Ra 0.421 µm)
- Very fast assembly
- Cable diameter 3.2 – 22.2 mm
- Very large sealing areas and clamping areas
- High cable density
- High strain relief
- Dual sealing of cables (IP66/IP68)
- Suitable for metric cut-outs
- Reproducible cleaning process
- Very low moisture absorption
- High resistance to aromatic solvents, oils, greases, mineral products
- No corrosion possible because plastics have been processed
- Maintenance free

Specifications

Material	Polyamide and elastomer FDA compliant material Food approval acc. to 1935/2004/EG Food approval acc. to (EU) 10/2011
IP protection	IP65/66/67/68
Flame class	UL 94 HB
Colour	Blue (similar to Signal blue RAL 5005)
Temperature	-40°C to +80°C
Properties	Halogen-free, silicone-free

i The KEL-DPZ-HD is also available as a cleanroom version, see page 341. Single-piece packaging units are available on request.

KEL-DPZ-HD
Cable entry plates
Hygienic Design Line



Type	Order No.	Number of cables	Thread metric	Thread length	Max. wall thickness	External diameter	Mounting height	PU
KEL-DPZ-HD 32 4	70351	3× 3.2 - 6.5 mm 1× 7.2 - 12.5 mm	M32 × 1.5	14 mm	7.0 mm	44 mm	8 mm	5
KEL-DPZ-HD 32 4-2	70352	4× 5 - 9.5 mm	M32 × 1.5	14 mm	7.0 mm	44 mm	8 mm	5
KEL-DPZ-HD 32 7	70353	7× 3.2 - 6.5 mm	M32 × 1.5	14 mm	7.0 mm	44 mm	8 mm	5
KEL-DPZ-HD 40 8	70354	4× 3.2 - 6.5 mm 4× 5 - 10.2 mm	M40 × 1.5	14 mm	7.0 mm	52 mm	8 mm	5
KEL-DPZ-HD 50 8	70355	5× 5 - 10.2 mm 3× 7.2 - 12.5 mm	M50 × 1.5	14 mm	6.0 mm	62 mm	8 mm	5
KEL-DPZ-HD 50 10	70356	7× 3.2 - 6.5 mm 2× 5 - 10.2 mm 1× 16 - 22.2 mm	M50 × 1.5	14 mm	6.0 mm	62 mm	8 mm	5
KEL-DPZ-HD 50 12	70357	4× 3.2 - 6.5 mm 8× 5 - 10.2 mm	M50 × 1.5	14 mm	6.0 mm	62 mm	8 mm	5
KEL-DPZ-HD 50 19	70358	19× 3.2 - 6.5 mm	M50 × 1.5	14 mm	6.0 mm	62 mm	8 mm	5
KEL-DPZ-HD 63 9	70359	1× 3.2 - 6.5 mm 3× 5 - 10.2 mm 4× 9 - 16.2 mm 1× 16 - 22.2 mm	M63 × 1.5	14 mm	6.0 mm	75 mm	8 mm	5
KEL-DPZ-HD 63 13	70360	4× 3.2 - 6.5 mm 4× 5 - 10.2 mm 5× 9 - 16.2 mm	M63 × 1.5	14 mm	6.0 mm	75 mm	8 mm	5
KEL-DPZ-HD 63 14	70361	14× 5 - 10.2 mm	M63 × 1.5	14 mm	6.0 mm	75 mm	8 mm	5
KEL-DPZ-HD 63 35	70362	35× 3.2 - 6.5 mm	M63 × 1.5	14 mm	6.0 mm	75 mm	8 mm	5



Can be combined with TE-M thread extension

*4X for indoor use only

ST-B-HD | ST-B-HDD

Plugs for cable entry plates
Hygienic Design Line



icotek offers plugs of the type ST-B-HD in the signal colour blue and in a detectable version of the type ST-B-HDD. The signal colour blue ensures a clear visual color recognition.

The ST-B-HDD plugs consist of a combination of polymer compound and metal particles. These can be sorted out using metal detectors, X-ray devices and visual detection systems.

The ST-B-HD and ST-B-HDD plugs are particularly suitable for pharmaceutical applications and for the food industry.

Advantages & benefits

- Sealing of pierced cable entry membranes which are no longer in use
- Blue colour for clear visual recognition
- ST-B-HDD: Detectable using metal detectors X-ray devices
- High resistance to aromatic solvents, oils, greases, mineral products

Specifications

Material	Polypropylene
Colour	Blue (similar to Signal blue RAL 5005)
Temperature	-40°C to +120°C
Properties	Food approval acc. to 1935/2004/EG and (EU) 10/2011 ST-B-HDD: Detectable by V2A particles

Type	Order No.	Diameter D1	Diameter D2	Length L	PU
ST-B-HD 6	70500	8 mm	6 mm	16 mm	10
ST-B-HD 10	70501	12 mm	10 mm	16 mm	10
ST-B-HD 12	70502	15 mm	12 mm	16 mm	10
ST-B-HD 16	70503	19 mm	16 mm	16 mm	10
ST-B-HD 22	70504	25 mm	22 mm	21 mm	10
ST-B-HDD 6 detectable	70620	8 mm	6 mm	16 mm	10
ST-B-HDD 10 detectable	70621	12 mm	10 mm	16 mm	10
ST-B-HDD 12 detectable	70622	15 mm	12 mm	16 mm	10
ST-B-HDD 16 detectable	70623	19 mm	16 mm	16 mm	10
ST-B-HDD 22 detectable	70624	25 mm	22 mm	21 mm	10

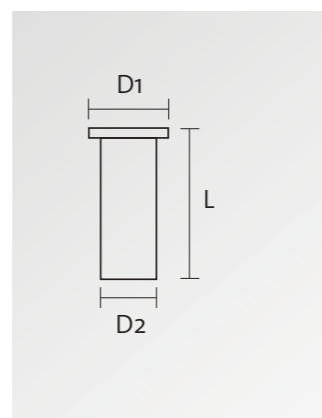

Detectable cable ties KB-HDD

Type	Length	Width	Order No.	PU
Cable ties KB 2.5 x 100 HDD	100 mm	2.5 mm	70680	100
Cable ties KB 3.6 x 150 HDD	150 mm	3.6 mm	70681	100
Cable ties KB 4.8 x 200 HDD	200 mm	4.8 mm	70682	100
Cable ties KB 4.8 x 300 HDD	300 mm	4.8 mm	70683	100

Detectable holders for cable ties KBH-HDD

Type	Length	Width	Order No.	PU
Holder for cable ties KBH 27 x 27 HDD	27 mm	27 mm	70710	100



KB-HDD | KBH-HDD

Detectable cable ties and holders for cable ties
Hygienic Design Line

The detectable cables ties and holders for cable ties are particularly suitable for pharmaceutical applications and for the food industry. The cable ties can be used to close packagings and transport containers.

The detectable cable ties and holders are used to install cables in the production systems. Cable ties are proven aids for the economical bundling and fastening of cables, cable harnesses, pipes and hoses. At the same time, the cable ties achieve a very high strain relief.

The holder is mounted using a screw assembly or an adhesive surface.

Advantages & benefits

- Cable ties: High resistance to aromatic solvents, oils, greases, mineral products
- Blue colour for clear visual recognition
- Detectable using metal detectors X-ray devices
- Support in quality assurance within food production, for example within the framework of HACCP

Specifications KB-HDD

Material	Polyamide
Colour	Blue (similar to Signal blue RAL 5005)
Temperature	-40°C to +60°C

Specifications KBH-HDD

Material	Polyamide
Dimensions	27 x 27 mm
Colour	Blue (similar to Signal blue RAL 5005)
Temperature	-40°C to +60°C; recommended application temperature +15°C to +40°C
Properties	For cable ties up to 4.8 mm wide

12 ALLIOLiGHT

Lighting systems for industry and automation



Efficient LED lighting for industry and automation

As a long-standing partner for the industry, icotek is known worldwide for innovative cable entry systems with the highest quality standards. With the acquisition of the luminaire manufacturer Alliolight (all-in-one-light, i.e. luminaires for all areas of application in industry), founded in 1990, we are now expanding our product portfolio around the illumination of enclosures, IT applications as well as machines of all kinds. Over 30 years of experience in the field of luminaires and accessories as well as renowned customers from all over the world guarantee the highest quality – made in Germany.

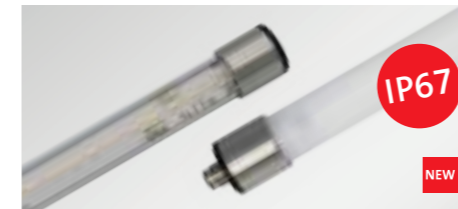

Machine luminaire
Chemical-resistant borosilicate glass or impact-resistant polycarbonate tube, protection class IP67 and protection category III

TUBE

358 – 359



Enclosure luminaire
with integrated socket, with robust aluminium housing, available with motion sensor, protection category I

ALU-LINE

360 – 361



Enclosure luminaire
with 190° rotating tube, available with motion sensor, protection category II

ALLIO

362 – 363



Accessories
for ALLIOLiGHT system luminaires
Connecting cable, through-wiring cable, door operated switch, panels

364 – 365

Robust machine luminaire
with protection class IP67
TUBE

The TUBE system luminaire provides effective lighting for machinery and equipment, with M12 connectors for standardised connection.

The luminaire is easy to mount, rotates and offers a circuit-independent service life of 50,000 operating hours.

Depending on the application, you can choose different materials for the tubes: the TUBE is available in chemical-resistant borosilicate glass and in impact-resistant polycarbonate. Fluctuating temperatures, oil, water or various chemicals therefore affect neither the luminosity nor the service life.

The connecting cable is not included in the scope of delivery and must be ordered separately. Mounting clips are included in the delivery.

Advantages & benefits

- Chemical-resistant borosilicate glass or impact-resistant polycarbonate tube
- Protection class IP67
- Completely maintenance-free product
- High energy efficiency thanks to High Power LED
- Compact round design \varnothing 28 mm, suitable for the tightest installation situations
- Easy retrofitting in existing machines
- With rotating LED tube
- Stainless steel end caps
- Cable connection via M12 connector

Specifications

Tube material	Borosilicate glass or polycarbonate
End caps material	Stainless steel
Mounting clips material	Polypropylene (PP)
Operating voltage	24 V DC
Rated power	see table
Protection class	IP67 (certified acc. to EN 60598-1)
Protection category	III (Protective extra-low voltage)
Operating temperature	-20°C to +50°C
Tube diameter	24 mm
End caps diameter	28 mm
Service life of illuminant	50 000 hours
Light colour	Borosilicate glass: 5000 K, Polycarbonate: 5600 K

Accessories

Connecting cable	364
------------------	-----



LED tube in borosilicate glass



LED tube in polycarbonate



TUBE
Robust machine luminaire
with protection class IP67

Type	Length	Tube material	Rated power	Luminous flux Light colour	Colour rendering index CRI	Colour mounting clips	Protection class	Order No.
TUBE system luminaire 13 W	570 mm	Polycarbonate	13 W	1700 lm 5600 K	> 80	black	IP67	81500
TUBE system luminaire 26 W	1080 mm	Polycarbonate	26 W	3400 lm 5600 K	> 80	black	IP67	81501
TUBE system luminaire 8 W	300 mm	Polycarbonate	8 W	1000 lm 5600 K	> 80	black	IP67	81502
TUBE system luminaire 11,2 W	330 mm	Borosilicate glass	11,2 W	1650 lm 5000 K	> 80	black	IP67	81503
TUBE system luminaire 16,8 W	615 mm	Borosilicate glass	16,8 W	2775 lm 5000 K	> 80	black	IP67	81504

Accessories for TUBE

Description	Length	Version	Colour	Order No.
Connecting cable	5 m	M12 connector female, open cable end	black	81530
Connecting cable	10 m	M12 connector female, open cable end	black	81531

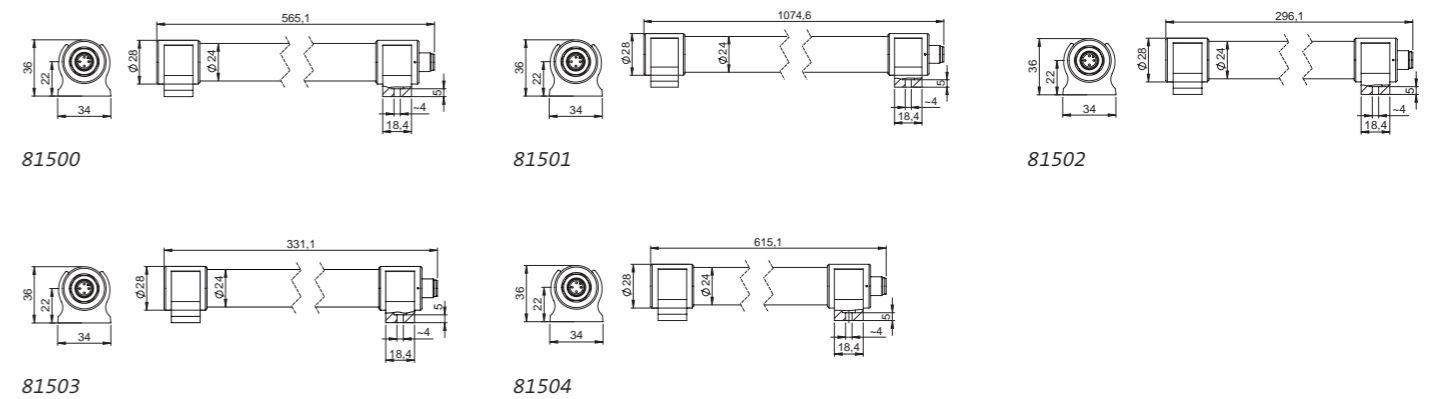

Assembly with mounting clips (included in the delivery)

LED lighting
with integrated socket
ALU-LINE

The ALU-LINE system luminaires provides effective lighting in enclosures for industrial and IT applications. Their aluminium housing makes them particularly high-quality and stable.

The ALU-LINE luminaire offers an integrated socket as a practical additional benefit. This is available in EU, CH, BE or GB versions.

The High Power LED illuminates with 1350 lumens and provides a balanced homogeneous area light. Another advantage is that the through-wiring of several luminaires is possible.

Some versions are equipped with a motion sensor with 120° sensitivity angle, max. distance of 3 m and illumination time 8 minutes.

Mounting brackets are included in the delivery.

Advantages & benefits

- Integrated socket available in different versions: EU, CH, BE, GB
- High-quality and stable aluminium housing
- Various mounting types: screw assembly and assembly on top-hat rail 35 mm
- Assembly aid via integrated magnets
- Effective LED lighting with 1350 lm
- Available with motion sensor
- Through-wiring of several luminaires possible
- Door operated switch available as an option

Specifications

Cover material	Polycarbonate
Housing material	Aluminium
Motion sensor	Infrared, illumination time 8 minutes
Protection class	IP20
Protection category	I (Protective conductor connection)
Operating temperature	-20°C to +50°C
Service life of illuminant	50 000 hours
Light colour	5600 K
Luminous flux	1350 lm
Rated power	12 W

Accessories

Door operated switch	365
Connecting cable	364
Through-wiring cable	364
Panel for 19" rack	365



Available with motion sensor



With integrated socket



ALU-LINE
LED lighting
with integrated socket

Type	Material	Rated power	Luminous flux Light colour	Colour rendering index CRI	Socket	Protection class	Order No.
ALU-LINE system luminaire EU	Aluminium, PMMA	12 W	1350 lm 5600 K	> 80	EU	IP20	81300
ALU-LINE system luminaire BE	Aluminium, PMMA	12 W	1350 lm 5600 K	> 80	BE	IP20	81301
ALU-LINE system luminaire CH	Aluminium, PMMA	12 W	1350 lm 5600 K	> 80	CH	IP20	81302
ALU-LINE system luminaire GB	Aluminium, PMMA	12 W	1350 lm 5600 K	> 80	GB	IP20	81303
ALU-LINE system luminaire EU with motion sensor	Aluminium, PMMA	12 W	1350 lm 5600 K	> 80	EU	IP20	81304
ALU-LINE system luminaire BE with motion sensor	Aluminium, PMMA	12 W	1350 lm 5600 K	> 80	BE	IP20	81305
ALU-LINE system luminaire CH with motion sensor	Aluminium, PMMA	12 W	1350 lm 5600 K	> 80	CH	IP20	81306
ALU-LINE system luminaire GB with motion sensor	Aluminium, PMMA	12 W	1350 lm 5600 K	> 80	GB	IP20	81307

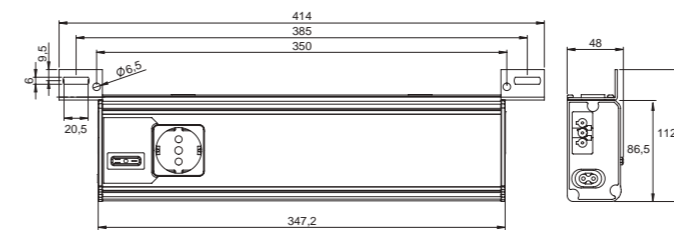

Version without motion sensor, with socket for door operated switch

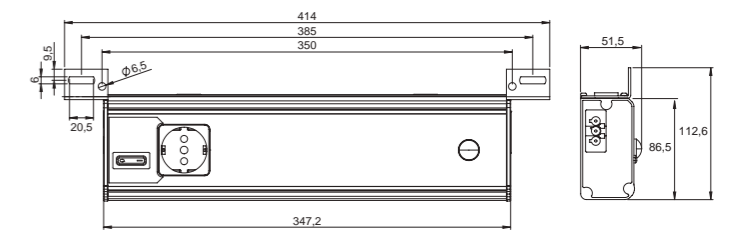

Version with motion sensor, without socket for door operated switch



Assembly with screws on profiles



Assembly with screws on surfaces



Assembly on 35 mm top hat DIN rails

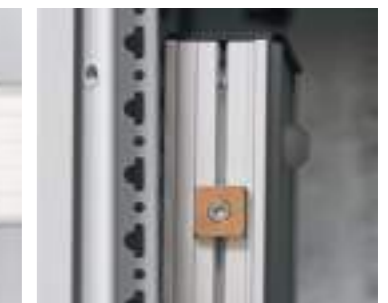

Assembly aid via integrated magnets

Compact LED lighting
with 190° rotating LED tube
ALLIO

With its compact design and 190° rotating tube, the ALLIO system luminaire offers space-saving lighting for enclosures. This also enables easy retrofitting in existing enclosures.

The High Power LED illuminates with 1050 lumens and offers a service life of at least 50,000 hours. The opal white polycarbonate tube provides a homogeneous, glare-free area light. The connecting cable is integrated.

Some versions are equipped with a motion sensor with 120° sensitivity angle, max. distance of 3 m and illumination time 30 seconds.

Advantages & benefits

- Compact design with 190° rotating LED tube
- Various mounting types: with magnets, screw assembly or snap-in assembly in the 19" server rack
- Integrated connecting cable
- Easy retrofitting in existing enclosures
- Effective LED lighting with 1050 lumens
- Available with motion sensor
- Door operated switch available as an option

Specifications

Tube material	Polycarbonate
Housing material	Polycarbonate
Housing colour	RAL 7035, similar light grey
Motion sensor	Infrared, illumination time 30 seconds
Protection class	IP20
Protection category	II (Protective insulation)
Operating temperature	-20°C to +50°C
Service life of illuminant	50 000 hours
Light colour	5600 K
Luminous flux	1000 lm
Rated voltage	see table
Rated power	8 W

Accessories

Door operated switch	365
Panel for 19" rack	365



Available with motion sensor



Panel for 19" rack available as an option



ALLIO
Compact LED lighting
with 190° rotating LED tube

Type	Tube material	Rated voltage	Rated power	Luminous flux Light colour	Colour rendering index CRI	Connection	Order No.
ALLIO system luminaire	Polycarbonate	24 V DC	8 W	1000 lm 5600 K	> 80	3 m, ferrules	81100
ALLIO system luminaire with motion sensor	Polycarbonate	24 V DC	8 W	1000 lm 5600 K	> 80	3 m, ferrules	81101
ALLIO system luminaire	Polycarbonate	230 V AC	8 W	1000 lm 5600 K	> 80	3 m, ferrules	81102
ALLIO system luminaire	Polycarbonate	230 V AC	8 W	1000 lm 5600 K	> 80	1,5 m round pin attachment plug	81103
ALLIO system luminaire	Polycarbonate	100 – 240 V AC	8 W	1000 lm 5600 K	> 80	3 m, ferrules	81104
ALLIO system luminaire with motion sensor	Polycarbonate	100 – 240 V AC	8 W	1000 lm 5600 K	> 80	3 m, ferrules	81105

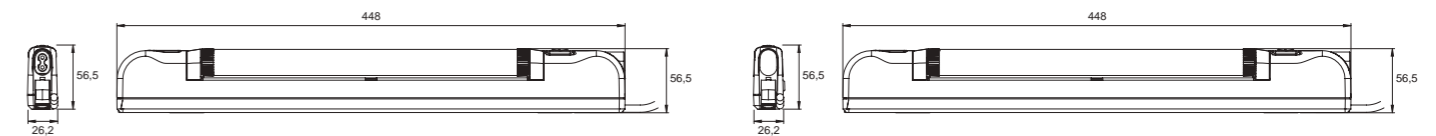

Version without motion sensor, with socket for door operated switch

Version with motion sensor, without socket for door operated switch



Assembly with integrated magnets



Assembly with screws on profiles and surfaces



Snap-in assembly in the 19" rack

Accessories
for ALLIOLiGHT system luminaires

Accessories
for ALLIOLiGHT system luminaires

Accessories for TUBE



Description	Length	Version	Colour	Order No.
Connecting cable	5 m	M12 connector female, open cable end	black	81530
Connecting cable	10 m	M12 connector female, open cable end	black	81531



Description	Inner diameter	Material	Colour	Order No.
Mounting clips (spare part)	28 mm	Polypropylene (PP)	black	91070

Accessories for ALU-LINE



Description	Length	Version	Order No.
Connecting cable	3 m	Connector GST18 female, wire end ferrules	81330



Description	Length	Version	Order No.
Through-wiring cable	0,6 m	Connector GST18 female, male	81331
Through-wiring cable	1,0 m	Connector GST18 female, male	81332

Accessories for ALU-LINE and ALLIO



Description	Length connection cable	Connector	Order No.
Door operated switch	1,5 m	angled	81333
Door operated switch	0,6 m	angled	81334
Door operated switch	0,6 m	straight	81132
Door operated switch	1,5 m	straight	81133

Accessories for ALU-LINE



Description	Dimensions	drill-hole-ø	Surface	Colour	Order No.
Mounting plate for 19" rack	111 x 43,4 mm	7 mm	powder-coated	black	81337

Accessories for ALLIO



Description	Surface	Colour	Order No.
Panel for 19" rack	powder-coated	RAL 7035 light grey	81134
Panel for 19" rack	powder-coated	RAL 9005 black	81135



Table with columns: Product, IP rating (IP54-IP68), UL 50E rating (12, 4X), cURus, RINA, DNV-GL, EN45545-2, UV, ECOLAB, RoHS, Cleanroom, Flame class UL94 (HB, V-0), Halogen free (Silicone free). Rows include Product group 1 and various KEL, KVT, KT, and KTMB models.



Table with columns: Product, IP rating (IP54-IP68), UL 50E rating (12, 4X), cURus, RINA, DNV-GL, EN45545-2, UV, ECOLAB, RoHS, Cleanroom, Flame class UL94 (HB, V-0), Halogen free (Silicone free). Rows include Product group 2 and various DT, ST, KEL, FT, KEL, KTM, KEL, KTF, QVT, and KEL-DPU/KEL-DPZ models.

Product																			
	IP rating						UL 50E rating		cURus	RINA	DNV-	EN45545-2	UV	ECOLAB	RoHS	Cleanroom	Flame class UL94		Halogen free
	IP54	IP64	IP65	IP66	IP67	IP68	12	4X		GL	HL3						HB	V-0	Silicone free
KEL-DP-E gy	■	■					■		■	■	■	■	■	■	■		■		■
KEL-DP-E bk	■	■					■		■	■	■	■	■	■	■		■		■
KEL-DP round gy	■	■	■				■		■	■	■	■	■	■	■		■		■
KEL-DP round bk	■	■	■				■		■	■	■	■	■	■	■		■		■
ST-B							■		■					■			■		■
KEL-SCDP-TR	■	■	■						■	■	■	■	■	■	■		■		■
KEL-SCDP KEL-SCDP-RW	■	■	■						- ■	■	■	■	■	■	■		■		■
KEL-DPF gy	■	■	■	■		■		■	■	■	■	■	■	■	■		■		■
KEL-DPF bk	■	■	■	■		■		■	■	■	■	■	■	■	■		■		■
KEL-JUMBO flex	■						■		■		■	■	■	■	■		■		■
KEL-ULTRA flex	■	■	■	■			■		■	■	■	■	■	■	■		■		■
Product group 3																			
KZL									■	■	■	■	■	■	■		■		■
SF ZL									■	■	■	■	■	■	■		■		■
ZL									■	■	■	■	■	■	■		■		■
ZL-AB									■	■	■	■	■	■	■		■		■
ZL 03 04 05									■	■	■	■	■	■	■		■		■
KBH-S KBH-R									■	■									
Product group 4																			
EMV-KEL-DS	■								■					■			■		■
EMV-KVT-DS	■								■					■			■		■
Product group 5																			
CONFIX FWS-A/-B gy	■																■		■
CONFIX FWS-A/-B bk	■																■		■
Product group 6																			
KDR-ESR KDRS-ESR	■									■				■			■		■
KDR2 KDR-BMP/MP	■													■					
FP-AX/FP-AE	■	■	■	■										■					
FP-KX/KL	■													■					
FP-BG/FP-FL21		IP54												■					
BPK	■	■					■		■					■			■		■
BPK-RF	■						■		■					■			■		■
BPM	■	■	■											■					
BPK-SNAP	■													■			■		

Product																				
	IP rating						UL 50E rating		cURus	RINA	DNV-	EN45545-2	UV	ECOLAB	RoHS	Cleanroom	Flame class UL94		Halogen free	
	IP54	IP64	IP65	IP66	IP67	IP68	12	4X		GL	HL3						HB	V-0	Silicone free	
TE-M													■			■		■		■
Drainage device	■	■	■	■	■	IP69K										■				
PCE	■	■	■	■	■	■	■									■				
KGM																■		■	■	
Product group 7																				
KEL-BES(-S) 24/16/10/round																■		■	■	
Product group 10																				
KEL-ER CR	■	■	■	■	■			■	■	■	■	■	■	■	■		■		■	
KEL-U CR	■							■		■	■	■	■	■	■		■		■	
KEL-DPZ CR gy/bk	■	■	■	■	■			■		■	■	■	■	■	■	■	-	■	■	
KEL-DPZ round CR gy/bk	■	■	■	■	■			■		■	■	■	■	■	■	■	-	■	■	
KEL-DPZ-HD CR	■	■	■	■	■	■										■		■	■	
Product group 11																				
KEL-ER-BL series	■	■	■																in progress	
KT-BL	■	■	■																in progress	
KEL-DPU-HD	■	■	■	■	■	■										■		■		
KEL-DPZ-HD	■	■	■	■	■	■										■		■		
Product group 12																				
TUBE	■	■	■	■	■														in progress	
ALU-LINE		IP20																	in progress	
ALLIO		IP20																	in progress	

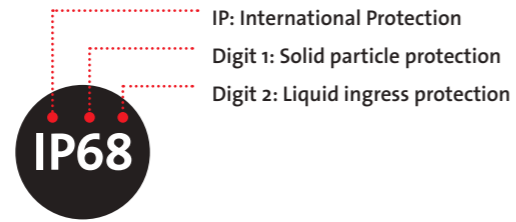

IP protection classes according to EN 60529

1st digit	Solid particle protection...	2nd digit	Liquid ingress protection...
0	no protection	0	no protection
1	against any surface of the body > 50 mm	1	against dripping water (vertically falling drops)
2	against any surface of the body > 12.5 mm	2	against dripping water when tilted at 15°
3	against objects > 2.5 mm (tools)	3	against spraying water at any angle up to 60°
4	against objects > 1 mm (most wires)	4	against splashing water from any direction
5	Dust protected	5	against water jets from any direction
6	Dust tight	6	against powerful water jets from any direction by a nozzle
6		7	Suitable for temporary immersion in water up to 1 m depth
6		8	Suitable for continuous immersion in water*

Why you should only rely on the UL Type Rating according to UL 50E



UL type rating acc. to UL 50E

The UL type rating is required for enclosures, cable entry components etc. for which an UL approval is required – regardless of the installation location. The UL type rating according to UL 50E requires intensive testing!

If a customer has to deliver a device according to UL Type 4X to the U.S. and installs a cable entry component, the manufacturer of which only specifies as NEMA 4X, this can lead to big problems. The UL inspector who approves the device usually also requests the corresponding test certificate from the UL. If this cannot be shown, the component has to be removed because the device does not meet the requirements of UL 50E.

All icotek products with a type rating have been tested and certified by UL according to UL 50E!



NEMA types

Using the NEMA rating lies with the responsibility of the manufacturer. That means: For enclosures, cable entry components etc. that are not particularly used for the North American market and for which no UL approval is required, the NEMA rating is sufficient.

It is also the sole responsibility of the manufacturer whether he checks the component on tightness at all or whether he just claims a NEMA conformity. An examination is not absolutely necessary. Regardless of whether the product is delivered to the USA or not, proof that the product corresponds to the tightness specified by the manufacturer is ensured by the type test according to UL 50E.

Appendix

Flammability classification according to UL 94

Flame class UL94 HB

Applying the horizontal burning test the material burns slowly. For parts with a thickness up to 3 mm the burning speed must not be faster than 3 inches/min and for parts with a thickness over 3 mm the burning speed must not be faster than 1.5 inches/mm.

Materials which burn faster are not UL certified.



Flame class UL 94 V-2

Applying the vertical burning test, the material must normally extinguish itself after 25 seconds or less, but max. after 30 seconds. The material may drop and cotton wool placed under the probe may inflame. The material must not glow longer than 60 seconds.

Flame class UL 94 V-1

Applying the vertical burning test, the material must normally extinguish itself after 25 seconds or less, but max. after 30 seconds. The material may drop and cotton wool placed under the probe may inflame. The material must not glow longer than 30 seconds.

Flame class UL 94 V-0

Applying the vertical burning test, the material must normally extinguish itself after 5 seconds or less, but max. after 10 seconds. The material may drop down, but cotton wool placed under the probe must not inflame. The material must not glow longer than 30 seconds.

Appendix

General reference notes



We provide all the information on chemical and physical properties of our products and technical advice to the best of our knowledge.

Please do your own examinations and tests to determine the practical suitability of the products for the usage intended.

Application, use and installation of the products is the customer's responsibility. Legal and regulatory provisions and any rights to third parties have to be observed.

Moreover our general terms and conditions, which can be requested from us, apply.

This catalogue was prepared with the greatest care. All technical data and information have been reviewed before printing. Due to continuous improvement and development of our production programme we reserve, modify products from this catalogue or to take out products from our product range. Therefore, technical information and products which are included in this catalogue may differ – without prior notice.

Full or partial use and reproduction of this catalogue (drawings, images, texts, logos) are prohibited without written permission.

Order No.	Page	Order No.	Page	Order No.	Page	Order No.	Page	Order No.	Page	Order No.	Page
31100	292	31590	251	32297	171	32803	231	36234	228	36472	228
31105	292	31592	251	32351	174	32804	231	36235	202	36482	228
31110	292	31594	251	32352	174	32805	231	36236	202	36484	228
31120	292	31596	251	32353	174	32806	232	36237	203	36486	228
31130	292	31598	251	32354	174	32807	232	36238	203	36488	228
31140	292	31600	251	32355	174	32808	232	36243	201	36490	228
31200	252	31602	251	32356	174	32809	232	36244	201	36500	200
31210	252	31604	251	32357	174	32810	232	36245	201	36502	200
31215	252	31606	251	32358	174	32811	232	36246	201	36504	201
31220	252	31610	251	32360	171	32812	232	36247	201	36506	201
31230	252	31612	251	32361	171	32815	232	36248	201	36520	226
31235	252	31614	251	32362	171	32823	232	36249	201	36522	226
31240	252	31616	251	32363	171	32824	232	36250	201	36524	226
31250	252	31618	251	32364	171	32825	232	36251	207	36525	224
31260	252	31620	251	32365	171	32847	232	36252	201	36526	226
31300	253	31622	251	32366	171	32848	232	36253	199	36527	224
31310	253	31624	251	32367	171	32849	232	36255	199	36530	228
31315	253	31626	251	32695	230	32850	232	36256	199	36540	228
31320	253	32000	168	32700	230	32868	232	36257	199	36550	228
31330	253	32001	168	32701	230	32870	232	36258	199	36562	228
31335	253	32002	168	32702	230	32872	232	36259	199	36611	203
31340	253	32003	168	32703	230	32873	231	36282	203	36612	203
31350	253	32004	168	32704	230	32878	230	36283	203	36696	206
31360	253	32005	168	32705	230	36000	293	36284	203	36700	206
31380	248	32006	168	32706	230	36002	293	36285	203	36704	207
31381	248	32007	168	32707	230	36008	293	36286	203	36708	207
31383	248	32112	172	32709	230	36010	293	36287	203	36810	201
31384	248	32114	172	32730	230	36016	293	36322	229	36815	201
31386	248	32116	172	32731	230	36018	293	36323	229	36820	201
31387	248	32222	170	32732	230	36024	293	36324	229	36850	200
31389	248	32224	170	32733	230	36026	293	36326	229	36855	200
31390	248	32226	170	32734	230	36032	293	36328	229	36860	200
31392	248	32228	170	32735	230	36034	293	36330	229	36865	200
31393	248	32230	170	32736	230	36040	293	36332	229	36870	200
31395	248	32232	170	32737	230	36042	293	36400	228	36875	200
31396	248	32234	170	32738	230	36048	293	36412	228	36880	200
31410	249	32236	170	32739	230	36050	293	36414	228	36885	200
31411	249	32250	173	32741	230	36056	293	36416	228	36910	198
31413	249	32251	172	32742	230	36058	293	36418	228	36915	198
31414	249	32252	172	32743	230	36064	293	36422	228	36920	198
31416	249	32260	173	32744	230	36066	293	36424	228	36925	198
31417	249	32262	173	32746	230	36072	293	36426	228	36930	198
31419	249	32264	173	32758	231	36074	293	36428	228	36935	198
31420	249	32270	171	32759	231	36100	293	36430	228	36940	198
31422	249	32271	171	32760	231	36200	195	36432	228	36941	198
31423	249	32272	171	32761	231	36202	195	36434	228	36952	223
31425	249	32273	171	32762	231	36204	195	36436	228	36953	223
31426	249	32274	171	32763	231	36205	195	36438	228	36954	223
31550	250	32275	171	32764	231	36206	195	36440	228	36955	223
31552	250	32276	171	32765	231	36207	195	36442	228	36958	223
31554	250	32277	171	32766	231	36208	195	36444	228	36962	223
31556	250	32280	171	32767	231	36209	195	36446	228	36963	223
31558	250	32281	171	32768	231	36213	195	36448	228	36965	223
31560	250	32282	171	32769	231	36216	195	36450	228	36984	223
31562	250	32283	171	32770	231	36217	195	36452	228	36985	223
31564	250	32284	171	32771	231	36218	195	36454	228	37150	229
31566	250	32285	171	32772	231	36220	206	36458	228	37152	229
31570	250	32286	171	32773	231	36221	195	36459	228	37154	229
31572	250	32287	171	32774	231	36222	199	36460	228	37156	229
31574	250	32290	171	32775	231	36224	199	36462	228	37158	229
31576	250	32291	171	32776	231	36226	199	36464	228	37159	229
31578	250	32292	171	32777	231	36228	199	36465	228	37306	214
31580	250	32293	171	32778	231	36229	195	36466	228	37600	195
31582	250	32294	171	32800	231	36230	195	36467	228	37602	195
31584	250	32295	171	32801	231	36231	195	36470	228	37608	199
31586	250	32296	171	32802	231	36232	228	36471	228	37610	199

Order No.	Page	Order No.	Page	Order No.	Page	Order No.	Page	Order No.	Page	Order No.	Page	Order No.	Page	Order No.	Page	Order No.	Page
37612	198	39913	68	41218	69	41362	73	42061	47	42420	96						
37614	198	39914	72	41219	69	41363	69	42062	47	42421	97						
37616	201	39915	72	41220	69	41364	69	42063	47	42422	97						
37618	201	39916	72	41221	69	41365	69	42140	30	42423	97						
37620	200	39917	72	41222	69	41410	33	42141	30	42424	97						
37622	200	39918	72	41223	69	41415	33	42143	30	42425	96						
37630	202	39921	72	41224	69	41420	33	42144	30	42426	96						
37632	202	39922	72	41225	69	41425	33	42145	30	42427	96						
37640	210	39923	72	41226	69	41430	33	42147	31	42434	96						
37642	210	39924	72	41227	69	41432	75	42148	31	42435	97						
37650	210	39929	72	41228	69	41434	75	42149	31	42460	45						
37652	210	39930	72	41229	69	41436	75	42162	24	42461	45						
37680	209	39931	72	41230	69	41438	75	42164	24	42501	108						
37681	209	39932	72	41231	69	41440	75	42165	24	42502	108						
37682	209	39933	72	41232	69	41460	75	42168	24	42503	108						
37683	209	39934	68	41233	69	41465	75	42204	25	42504	108						
37684	209	39935	72	41234	69	41470	75	42206	25	42505	108						
37685	209	39936	72	41251	68	41475	75	42207	27	42506	108						
37687	209	39937	72	41252	69	41480	75	42208	27	42507	108						
37688	209	39938	72	41253	69	41485	75	42209	27	42508	108						
38005	221	39939	72	41257	72	41500	76	42212	25	42509	108						
38010	221	39940	72	41258	72	41510	76	42216	25	42510	108						
38015	221	39941	68	41260	73	41520	76	42221	28	42511	108						
38020	221	39942	72	41261	73	41530	76	42222	28	42512	108						
38025	221	39943	68	41262	73	41540	76	42223	29	42513	108						
38030	221	39944	72	41263	69	41550	76	42224	28	42514	108						
38035	221	39946	88	41264	69	41552	76	42225	28	42515	109						
38040	221	39947	88	41265	69	41991	287	42226	29	42516	109						
38045	221	39948	88	41302	68	41992	287	42227	29	42517	109						
38050	221	39949	88	41303	68	41994	287	42232	28	42518	109						
38105	222	39950	88	41304	68	41995	287	42233	29	42519	109						
38110	222	39952	86	41305	68	41996	287	42234	29	42520	109						
38115	222	39953	87	41306	68	42003	288	42241	23	42521	109						
38120	222	39954	87	41307	68	42004	288	42244	23	42540	108						
38125	222	39955	87	41308	68	42007	288	42247	23	42545	109						
38130	222	39956	87	41309	68	42008	288	42248	23	42550	110						
38135	222	39957	87	41310	68	42010	286	42249	17	42551	110						
38140	222	39961	85	41311	68	42011	287	42250	17	42552	110						
38145	222	39962	87	41312	68	42012	287	42258	17	42556	110						
38150	222	39963	87	41313	68	42013	287	42259	17	42557	110						
39110	226	39964	87	41314	68	42014	2										

Order No.	Page	Order No.	Page	Order No.	Page	Order No.	Page	Order No.	Page	Order No.	Page	Order No.	Page	Order No.	Page	Order No.	Page	Order No.	Page	Order No.	Page		
42604	117	42906	77	43462	144	43578	147	43815	133	44100	311	45203	57	47250	32	50658	161	52310	291	61065	182	73936	351
42605	117	42908	77	43463	144	43581	147	43816	133	44101	311	45204	57	47255	32	50700	131	52311	291	61065.9005	182	73938	351
42606	117	42909	77	43464	144	43583	147	43817	133	44102	311	45205	57	48162	11	50705	131	52312	291	61066	182	73940	351
42607	117	42920	269	43465	144	43585	147	43818	133	44103	311	45206	57	48165	11	50710	131	52313	291	61066.9005	182	73942	351
42608	114	42922	269	43466	145	43587	147	43819	133	44104	311	45212	57	48168	11	50711	131	52314	291	61067	182	73944	351
42609	117	42923	269	43467	145	43591	147	43832	285	44105	311	45215	57	48204	12	50715	132	52315	291	61067.9005	182	80000	317
42614	163	42924	269	43468	145	43592	149	43834	282	44106	311	45236	58	48206	12	50720	131	54162	15	61068	183	80002	317
42616	163	42941	269	43469	145	43593	149	43836	283	44400	269	45237	58	48212	12	50725	131	54165	15	61068.9005	183	80003	317
42620	286	42943	269	43470	145	43594	149	43838	283	44401	269	45238	58	48216	12	50730	132	54168	15	61069	183	80005	317
42630	162	42945	269	43480	159	43595	149	43840	283	44402	269	45239	58	48241	11	50732	139	54204	16	61069.9005	183	80006	317
42631	162	42952	269	43481	159	43596	149	43842	283	44403	269	45404	60	48244	11	50733	139	54206	16	61070	183	80007	320
42633	287	42953	269	43482	159	43597	149	43846	283	44404	269	45406	60	48247	11	50734	139	54212	16	61070.9005	183	80020	320
42644	116	42954	269	43483	159	43598	149	43848	283	44405	269	45414	60	48249	13	50735	132	54216	16	61071	183	80021	320
42645	116	42955	269	43490	159	43599	149	43852	281	44406	269	45416	60	48250	13	50736	139	54241	15	61071.9005	183	80022	320
42646	116	42956	269	43491	159	43622	105	43853	281	44407	269	45424	60	48258	13	50737	139	54244	15	61073	183	80023	320
42652	161	42957	269	43492	159	43626	105	43854	281	44408	269	45426	60	48259	13	50741	139	54247	15	61073.9005	183	80024	320
42653	161	42958	269	43493	159	43632	105	43855	281	44409	269	45450	55	49056	27	50750	139	54300	65	61074	183	80025	320
42654	161	42959	269	43508	143	43636	105	43856	281	44410	269	45452	55	50508	143	50751	139	54301	65	61074.9005	183	80026	320
42655	161	43070	263	43510	143	43642	104	43861	283	44411	269	45454	55	50510	143	50752	139	54302	65	61430	323	80027	320
42656	161	43071	263	43511	143	43643	104	43865	285	44500	259	45455	55	50511	143	50756	139	54303	65	61435	323	80028	320
42657	161	43072	263	43512	143	43644	104	43866	285	44501	259	45456	55	50512	143	50758	139	58000	309	61436	323	80029	320
42658	161	43073	263	43514	143	43645	104	43871	277	44502	259	45692	100	50514	143	50760	139	58006	309	61437	323	80030	320
42805	151	43074	263	43515	143	43655	104	43882	271	44503	259	45695	100	50515	143	50761	139	58012	309	70000.200	345	80034	320
42806	151	43075	263	43516	143	43656	104	43883	271	44504	259	45702	100	50516	143	50762	139	58018	309	70001.200	345	80049	318
42807	151	43076	263	43518	143	43658	104	43886	271	44505	259	45711	100	50518	143	50763	139	61002	186	70002.200	345	80050	318
42808	151	43077	263	43519	143	43659	104	43887	271	44506	259	45715	100	50519	143	50780	137	61003	186	70003.200	345	80051	318
42809	151	43078	263	43520	143	43660	104	43888	271	44507	259	45722	100	50520	143	50790	137	61004	186	70004.200	345	80052	318
42810	151	43079	263	43521	143	43700	131	43889	271	44508	259	45726	101	50521	143	50794	136	61011	187	70005.200	345	80053	318
42811	151	43080	263	43522	143	43705	131	43890	271	44509	259	45728	101	50522	143	50796	136	61012	187	70006.200	346	80054	318
42812	151	43081	263	43523	143	43710	131	43891	271	44510	259	45730	101	50523	143	50798	136	61013	187	70007.200	346	80055	318
42813	151	43082	263	43524	143	43711	131	43894	271	44511	259	45732	101	50524	143	50930	129	61014	187	70008.200	346	80056	318
42814	151	43083	263	43525	143	43715	132	43896	271	44512	261	45734	101	50525	143	50932	128	61018	186	70009.200	346	80057	318
42815	151	43084	263	43526	143	43720	131	43899	271	44513	261	45736	101	50526	143	50934	129	61019	186	70010.200	347	80058	318
42816	151	43250	267	43527	143	43725	131	43901	277	44514	261	45738	101	50527	143	50936	128	61021	187	70011.200	347	80059	318
42817	151	43251	267	43528	143	43730	132	43902	277	44515	261	45740	101	50528	143	50938	129	61022	187	70012.200	347	80060	318
42818	151	43252	267	43531	149	43732	139	43903	277	44520	265	46100	34	50531	149	50940	128	61023	187	70013.200	347	80061	318
42819	151	43253	267	43532	149	43733	139	43904	277	44521	265	46105	34	50532	149	50942	129	61024	187	70351	353	80062	318
42820	151	43254	267	43533	149	43734	139	43905	279	44522	265	46110	34	50533	149	50944	128	61025	187	70352	353	80063	318
42821	151	43255	267	43534	149	43735	132	43906	279	44523	265	46115	34	50550	150	51500	313	61026	187	70353	353	80064	318
42822	151	43300	275	43535	149	43736	139	43907	279	44524	265	46120	34	50551	150	51501	313	61027	187	70354	353	80065	319
42823	151	43302	275	43536	150	43737	139	43908	279	44525	265	46125	34	50552	150	51505	298	61028	187	70355	353	80070	321
42824	151	43304	275	43537	150	43741	139	43909	279	44526	265	46130	34	50553	150	51510	298	61030	179	70356	353	80075	318
42825	151	43306	275	43538	150	43750	139	43910	279	45024	56	46135	34	50554	150	51515	298	61031	179	70357	353	80120	321
42826	151	43308	275	43550	150	43751	139	43930	129	45025	56	46140	34	50555	150	51520	299	61032	179	70358	353	80121	321
42827	151	43310	275	43551	150	43752	139	43932	128	45026	56	46145	34	50556	150	51521	299	61033	179	70359	353	80122	321
42828	151	43312	275	43552	150	43756	139	43934	129	45027	56	46150	34	50560	149	51522	299	61045	179	70360	353	80123	321
42829	151	43314	275	43553	150	43758	139	43936	128	45028	57	46155	34	50562	150	51538	299	61046	179	70361	353	80124	321
42830	151	43316	275	43554	150	43760	139	43938	129	45029	57	46201	35	50564	150	51540	299	61047	179	70362	353	80125	321
42831	151	43318	275	43555	150	43761	139	43940	128	45030	57	46202	35	50566	150	52272	292	61048	180	70500	354	80126	321
42823	151	43320	275	43556	150	43762	139	43942	129	45031	57	46203	35	50567	150	52273	292	61049	180	70501	354	80128	321
42834	151	43322	275	43560	149	43763	139	43944	128	45034	56	46204	35	50568	150	52274	292	61050	180	70502	354	80149	319
42877	77	43324	275	43561	150	43780	137	44050	141	45035	56	46210	35	50569	150	52275	292	61051	180	70503	354	80150	319
42881	77	43334	273	43562	150	43790	137	44051	141	45036	56	46211	35	50570	150	52276	292	61052	180	70504	354	80151	319
42883	77	43340	273	43563	150	43794	136	44052	141	45037	56	46212	35	50576	147	52277	292	61053	180	70620	354	80152	319
42885	77	43346	273	43564	150	43796	136	44053	141	45105	292	46214	35	50578	147	52278	292						

Appendix Reference list

Appendix Reference list

Order No.	Page	Order No.	Page	Order No.	Page	Order No.	Page	Order No.	Page	Order No.	Page	Order No.	Page	Order No.	Page	Order No.	Page	Order No.	Page	Order No.	Page		
81101	363	99309	327	99558	239	36780.20	213	36784.31	213	36788.33	205	37505.10	216	38035.100	221	41203.600	334	41252.600	336	42241.200	23	43732.601	340
81102	363	99311	327	32695.01	197	36780.21	213	36784.32	213	36788.34	205	37505.11	216	38040.100	221	41203.601	334	41252.601	336	42241.400	23	43733.600	340
81103	363	99312	327	32695.011	197	36780.22	213	36784.33	213	36788.40	205	37505.12	216	38045.100	221	41204.600	334	41253.600	336	42244.200	23	43733.601	340
81104	363	99314	327	32695.02	197	36780.23	213	36784.34	213	36788.41	205	37505.13	216	38050.100	221	41204.601	334	41253.601	336	42244.400	23	43734.600	340
81105	363	99315	327	32707.01	197	36780.24	213	36784.40	213	36788.42	205	37505.20	216	38069.002	220	41205.600	334	42010.002	286	42247.200	23	43734.601	340
81133	365	99400	241	32707.011	197	36780.30	213	36784.41	213	36788.43	205	37505.21	216	38070.002	220	41205.601	334	42015.002	286	42247.400	23	43735.400	132
81134	365	99401	241	32707.02	197	36780.31	213	36784.42	213	36789.01	204	37505.22	216	38070.100	220	41206.600	334	42016.002	286	42248.200	23	43735.600	337
81135	365	99402	241	32707.021	197	36780.32	213	36784.43	213	36789.02	204	37505.23	216	38071.002	220	41206.601	334	42024.002	286	42248.400	23	43735.601	337
81300	361	99410	237	36222.002	199	36780.33	213	36785.01	212	36789.03	204	37505.30	216	38071.100	220	41207.600	334	42140.200	30	42249.200	17	43736.600	340
81301	361	99411	237	36224.002	199	36780.34	213	36785.02	212	36789.04	204	37505.31	216	38072.002	220	41207.601	334	42140.400	30	42249.400	17	43736.601	340
81302	361	99412	237	36235.002	203	36780.40	213	36785.03	212	36789.10	204	37505.32	216	38072.100	220	41208.600	334	42141.200	30	42250.200	17	43737.600	340
81303	361	99420	241	36236.002	203	36780.41	213	36785.04	212	36789.11	204	37505.33	216	38073.002	220	41208.601	334	42141.400	30	42250.400	17	43737.601	340
81304	361	99422	241	36251.100	207	36780.42	213	36785.10	212	36789.12	204	37507.01	217	38073.100	220	41209.600	334	42143.200	30	42258.200	17	43741.600	340
81305	361	99431	239	36253.100	207	36780.43	213	36785.11	212	36789.13	204	37507.02	217	38074.002	220	41209.601	334	42143.400	30	42258.400	17	43741.601	340
81306	361	99432	239	36255.100	207	36781.01	212	36785.12	212	36789.14	204	37507.03	217	38074.100	220	41210.600	334	42144.200	30	42259.200	17	43750.600	340
81307	361	99434	239	36256.100	207	36781.02	212	36785.13	212	36789.20	204	37507.10	217	38075.002	220	41210.601	334	42144.400	30	42259.400	17	43750.601	340
81330	364	99435	239	36257.100	207	36781.03	212	36785.14	212	36789.21	204	37507.11	217	38075.100	220	41211.600	334	42145.200	30	42261.200	17	43751.600	340
81331	364	99436	239	36258.100	207	36781.04	212	36785.20	212	36789.22	204	37507.12	217	38076.002	220	41211.601	334	42145.400	30	42320.200	41	43751.601	340
81332	364	99437	239	36259.100	207	36781.10	212	36785.21	212	36789.23	204	37507.13	217	38076.100	220	41212.600	334	42147.200	31	42320.400	41	43752.600	340
81333	365	99459	242	36296.1	196	36781.11	212	36785.22	212	36789.24	204	37507.20	217	38077.002	220	41212.601	334	42147.400	31	42322.200	41	43752.601	340
81334	365	99460	242	36296.2	196	36781.12	212	36785.23	212	36789.30	204	37507.21	217	38077.100	220	41213.600	334	42148.200	31	42322.400	41	43756.600	340
81332	365	99461	242	36297.1	196	36781.13	212	36785.24	212	36789.31	204	37507.22	217	38078.002	220	41213.601	334	42148.400	31	42324.200	41	43756.601	340
81337	365	99462	242	36297.2	196	36781.14	212	36785.30	212	36789.32	204	37507.23	217	38078.100	220	41214.600	334	42149.200	31	42324.400	41	43758.600	340
81500	359	99463	242	36297.3	196	36781.20	212	36785.31	212	36789.33	204	37507.30	217	38079.002	220	41214.601	334	42149.400	31	42330.200	42	43758.601	340
81501	359	99464	242	36297.4	196	36781.21	212	36785.32	212	36789.34	204	37507.31	217	38079.100	220	41215.600	334	42162.200	24	42330.400	42	43760.600	340
81502	359	99465	242	36297.5	196	36781.22	212	36785.33	212	36789.40	204	37507.32	217	39710.01	197	41215.601	334	42162.400	24	42332.200	42	43760.601	340
81503	359	99466	242	36298.1	196	36781.23	212	36785.34	212	36789.41	204	37507.33	217	39710.011	197	41216.600	336	42164.200	24	42332.400	42	43761.600	340
81504	359	99467	242	36298.2	196	36781.24	212	36785.40	212	36789.42	204	37510.1	216	39710.02	197	41216.601	336	42164.400	24	42333.200	43	43761.601	340
81530	359	99468	242	36301.2	196	36781.30	212	36785.41	212	36789.43	204	37510.2	216	39710.021	197	41217.600	336	42165.200	24	42333.400	43	43762.600	340
81531	359	99469	242	36302.2	196	36781.31	212	36785.42	212	36850.150	200	37510.3	216	39711.01	197	41217.601	336	42165.400	24	42334.200	43	43762.601	340
88001	79	99470	242	36303.2	196	36781.32	212	36785.43	212	36855.150	200	37512.1	217	39711.011	197	41218.600	336	42168.200	24	42334.400	43	43763.600	340
88002	219	99471	242	36500.002	201	36781.33	212	36786.1	203	36860.150	200	37512.2	217	39711.02	197	41218.601	336	42168.400	24	42336.200	43	43763.601	340
88005	111	99472	242	36502.002	201	36781.34	212	36786.2	203	36865.150	200	37512.3	217	39711.021	197	41219.600	336	42204.200	25	42336.400	43	43780.400	137
88006	218	99473	242	36650.1	214	36781.40	212	36786.3	203	36870.150	200	37514.1	217	39900.600	334	41219.601	336	42204.400	25	42350.200	50	43780.600	339
88031	184	99475	243	36650.2	214	36781.41	212	36786.4	203	36875.150	200	37514.2	217	39900.601	334	41220.600	336	42206.200	25	42360.200	50	43780.601	339
88032	184	99476	243	36650.3	214	36781.42	212	36786.5	203	36880.150	200	37514.3	217	39901.600	334	41220.601	336	42206.400	25	43675.001	137	43790.400	137
88033	184	99477	243	36650.4	214	36781.43	212	36786.6	203	36886.1	198	37590.150	199	39901.601	334	41221.600	336	42207.200	27	43675.001.600	339	43790.600	339
88034	185	99478	243	36653.1	214	36782.1	211	36787.1	202	36886.2	198	37591.150	199	39906.600	335	41221.601	336	42207.400	27	43675.001.601	339	43790.601	339
88035	185	99479	243	36656.1	214	36782.2	211	36787.151	202	36886.3	198	37594.150	206	39906.601	335	41222.600	336	42208.200	27	43675.101	137	43790.601	339
88036	185	99480	243	36656.2	214	36782.3	211	36787.152	202	36886.4	198	37595.150	206	39908.600	335	41222.601	336	42208.400	27	43675.101.600	339	43794.400	136
88037	185	99481	243	36656.3	214	36782.4	211	36787.153	202	36886.5	198	37608.100	206	39908.601	335	41223.600	336	42209.200	27	43675.101.601	339	43794.600	339
91069	364	99482	243	36696.002	207	36782.5	211	36787.154	202	36887.1	198	37610.100	206	39909.600	335	41223.601	336	42209.400	27	43700.400	131	43794.601	339
91070	364	99483	243	36700.002	207	36782.6	211	36787.155	202	36887.2	198	37612.100	206	39909.601	335	41224.600	336	42212.200	25	43700.600	337	43796.400	136
98047	237	99484	243	36778.1	211	36782.7	211	36787.156	202	36887.3	198	37612.150	206	39914.600	335	41224.601	336	42212.400	25	43700.601	337	43796.600	339
99142	78	99485	243	36778.2	211	36783.1	210	36787.2	202	36887.4	198	37614.100	206	39914.601	335	41225.600	336	42216.200	25	43705.400	131	43796.601	339
99152	301	99486	243	36778.3	211	36783.2	210	36787.3	202	36887.5	198	37614.150	206	39917.600	335	41225.601	336	42216.400	25	43705.600	337	43798.400	136
99153	299	99487	243	36778.4	211	36783.3	210	36787.4	202	36910.100	206	37620.150	200	39917.601	335	41226.600	336	42221.200	28	43705.601	337	43798.600	339
99190	89	99488	243	36778.5	211	36783.4	210	36787.5	202	36915.100	206	37622.150	200	39932.									

Appendix
Reference list



Order No.	Page	Order No.	Page	Order No.	Page	Order No.	Page	Order No.	Page	Order No.	Page
43816.400	133	48249.400	13	50760.601	340	54244.601	333	61057.9005	181	99301.203	326
43816.600	338	48249.600	332	50761.600	340	54247.200	15	61058.9005	181	99301.204	326
43816.601	338	48249.601	332	50761.601	340	54247.400	15	70351.600	341	99301.205	326
43817.400	133	48250.200	13	50762.600	340	54247.600	333	70351.601	341	99301.206	326
43817.600	338	48250.400	13	50762.601	340	54247.601	333	70352.600	341	99302.001	326
43817.601	338	48250.600	332	50763.600	340	58210.0362	301	70352.601	341	99302.002	326
43818.400	133	48250.601	332	50763.601	340	58210.0392	302	70353.600	341	99302.201	326
43818.600	338	48258.200	13	50780.400	137	58210.0397	301	70353.601	341	99302.202	326
43818.601	338	48258.400	13	50780.600	339	58210.0414	303	70354.600	341	99305.001	326
43819.400	133	48258.600	332	50780.601	339	58210.0435	301	70354.601	341	99305.002	326
43819.600	338	48258.601	332	50790.400	137	58210.0477	303	70355.600	341	99305.003	326
43819.601	338	48259.200	13	50790.600	339	58210.0495	301	70355.601	341	99305.004	326
43930.400	129	48259.400	13	50794.400	136	58210.0562	301	70356.600	341	99305.201	326
43932.400	129	48259.600	332	50794.600	339	58210.0592	302	70356.601	341	99305.202	326
43934.400	129	48259.601	332	50794.601	339	58210.0614	303	70357.600	341	99305.203	326
43936.400	128	49056.200	27	50796.400	136	58210.0635	301	70357.601	341	99305.204	326
43938.400	129	49056.400	27	50796.600	339	58210.0762	301	70358.600	341	99305.205	326
43940.400	128	50700.400	131	50796.601	339	58210.0792	302	70358.601	341	99306.001	326
43942.400	129	50700.600	337	50798.400	136	58210.0814	303	70359.600	341	99306.002	326
43944.400	128	50700.601	337	50798.600	339	58210.0835	301	70359.601	341	99306.003	326
47200.200	32	50705.400	131	50930.400	129	58210.0992	302	70360.600	341	99306.004	326
47220.200	32	50705.600	337	50932.400	128	58215.0392	302	70360.601	341	99306.201	326
47240.200	32	50705.601	337	50934.400	129	58215.0414	303	70361.600	341	99306.202	326
47250.200	32	50710.400	131	50936.400	128	58215.0477	303	70361.601	341	99306.203	326
47255.200	32	50710.600	337	50938.400	129	58215.0592	302	70362.600	341	99306.204	326
48162.200	11	50710.601	337	50940.400	128	58215.0614	303	70362.601	341	99307.001	326
48162.400	11	50711.400	131	50942.400	129	58215.0792	302	99300.001	326	99307.002	326
48162.600	332	50711.600	337	50944.400	128	58215.0992	302	99300.002	326	99307.201	326
48162.601	332	50711.601	337	51520.002	299	58221.0345	305	99300.003	326	99307.202	326
48165.200	11	50715.400	132	51521.002	299	58221.0363	305	99300.004	326	99308.001	326
48165.400	11	50715.600	337	51522.002	299	58221.0435	304	99300.005	326	99308.002	326
48165.600	332	50715.601	337	54162.200	15	58221.0445	305	99300.006	326	99308.201	326
48165.601	332	50720.400	131	54162.400	15	58221.0495	304	99300.010	327	99308.202	326
48168.200	11	50720.600	337	54162.600	333	58221.0835	304	99300.011	327	99309.001	326
48168.400	11	50720.601	337	54162.601	333	58222.0345	305	99300.012	327	99309.002	326
48168.600	332	50725.400	131	54165.200	15	58222.0363	305	99300.013	327	99309.201	326
48168.601	332	50725.600	337	54165.400	15	58222.0435	304	99300.014	327	99309.202	326
48204.200	12	50725.601	337	54165.600	333	58222.0445	305	99300.015	327		
48204.400	12	50730.400	131	54165.601	333	58222.0495	304	99300.016	327		
48204.600	332	50730.600	337	54168.200	15	58222.0563	305	99300.017	327		
48204.601	332	50730.601	337	54168.400	15	58222.0635	304	99300.018	327		
48206.200	12	50732.601	340	54168.600	333	58222.0835	304	99300.019	327		
48206.400	12	50733.600	340	54168.601	333	58225.0402	301	99300.020	327		
48206.600	332	50733.601	340	54204.200	16	58225.0452	301	99300.021	327		
48206.601	332	50734.600	340	54204.400	16	58225.0502	301	99300.022	327		
48212.200	12	50734.601	340	54204.600	333	58225.0652	301	99300.023	327		
48212.400	12	50735.400	132	54204.601	333	58230.0402	301	99300.024	327		
48212.600	332	50735.600	337	54206.200	19	58230.0452	301	99300.201	326		
48212.601	332	50735.601	337	54206.400	19	58230.0502	301	99300.202	326		
48216.200	12	50736.600	340	54206.600	333	582.3.0652	301	99300.203	326		
48216.400	12	50736.601	340	54206.601	333	61030.9005	179	99300.204	326		
48216.600	332	50737.600	340	54212.200	16	61031.9005	179	99300.205	326		
48216.601	332	50737.601	340	54212.400	16	61032.9005	179	99300.206	326		
48241.200	11	50741.600	340	54212.600	333	61033.9005	179	99301.001	326		
48241.400	11	50741.601	340	54212.601	333	61045.9005	179	99301.002	326		
48241.600	332	50750.600	340	54216.200	16	61046.9005	179	99301.003	326		
48241.601	332	50750.601	340	54216.400	16	61047.9005	179	99301.004	326		
48244.200	11	50751.600	340	54216.600	333	61048.9005	180	99301.005	326		
48244.400	11	50751.601	340	54216.601	333	61049.9005	180	99301.006	326		
48244.600	332	50752.600	340	54241.200	15	61050.9005	180	99301.007	327		
48244.601	332	50752.601	340	54241.400	15	61051.9005	180	99301.008	327		
48247.200	11	50756.600	340	54241.600	333	61052.9005	180	99301.009	327		
48247.400	11	50756.601	340	54241.601	333	61053.9005	180	99301.010	327		
48247.600	332	50758.600	340	54244.200	15	61054.9005	181	99301.011	327		
48247.601	332	50758.601	340	54244.400	15	61055.9005	181	99301.201	326		
48249.200	13	50760.600	340	54244.600	333	61056.9005	181	99301.202	326		



Grab your phone
and follow us on:





icotek GmbH & Co. KG

Bischof-von-Lipp-Straße 1
73569 Eschach | Germany
Tel +49 7175 9 23 80-0
Fax +49 7175 9 23 80-50
info@icotek.com
www.icotek.com

icotek (swiss) AG

Wiesenstrasse 14
9327 Tübach | Switzerland
Tel +41 71 858 23 23
Fax +41 71 858 23 24
info@icotek.ch
www.icotek.ch

icotek SARL

130, rue des terres Bourdin
69140 Rillieux-la-Pape | France
Tél +33 4 81 91 97 65
Fax +33 4 81 91 97 68
info@icotek.fr
www.icotek.fr

icotek Italia s.r.l.

Via Dante Alighieri, 26/28
20029 Turbigo (MI) | Italia
Tel +39 0331 152 03 23
info@icotek-italia.it
www.icotek-italia.it

icotek Corp.

3435 N Kimball Ave
Chicago, IL 60618 | USA
Phone +1 312.643.2315
info@icotek-usa.com
www.icotek-usa.com

icotek Limited

Unit C5, Broadoak Business Park
Ashburton Road West,
Trafford Park
Manchester M17 1RW | UK
Phone +44 161 222 3454
info@icotek.co.uk
www.icotek.co.uk

icotek Elektronik Tic. Ltd. Şti.

Fevzi Çakmak Mah.,
Bilginler Sok. No: 17/A-B
34899 | Pendik, İstanbul | Türkiye
Tel +90 216 396 59 59
info@icotek.com.tr
www.icotek.com.tr

**icotek Cable Management
Trading (Shanghai) Co. Ltd**

Room 504-1, 5th Floor,
No. 6 building, Lane 1158,
Zhongxin Road,
Songjiang District, 201615
Tel +86 21 5767 6805
Fax +86 21 5765 9635
info@icotek.cn
www.icotek.cn

icotek India Pvt Ltd

No 14-b, 4th Cross Rd
Veerasandra Industrial Area
Phase 2, Electronic City
Bengaluru, Karnataka 560100
India
Phone +91 953 567 3112
info@icotek.in
www.icotek.in