

CATALOG

Installation contactors

Modular DIN rail components

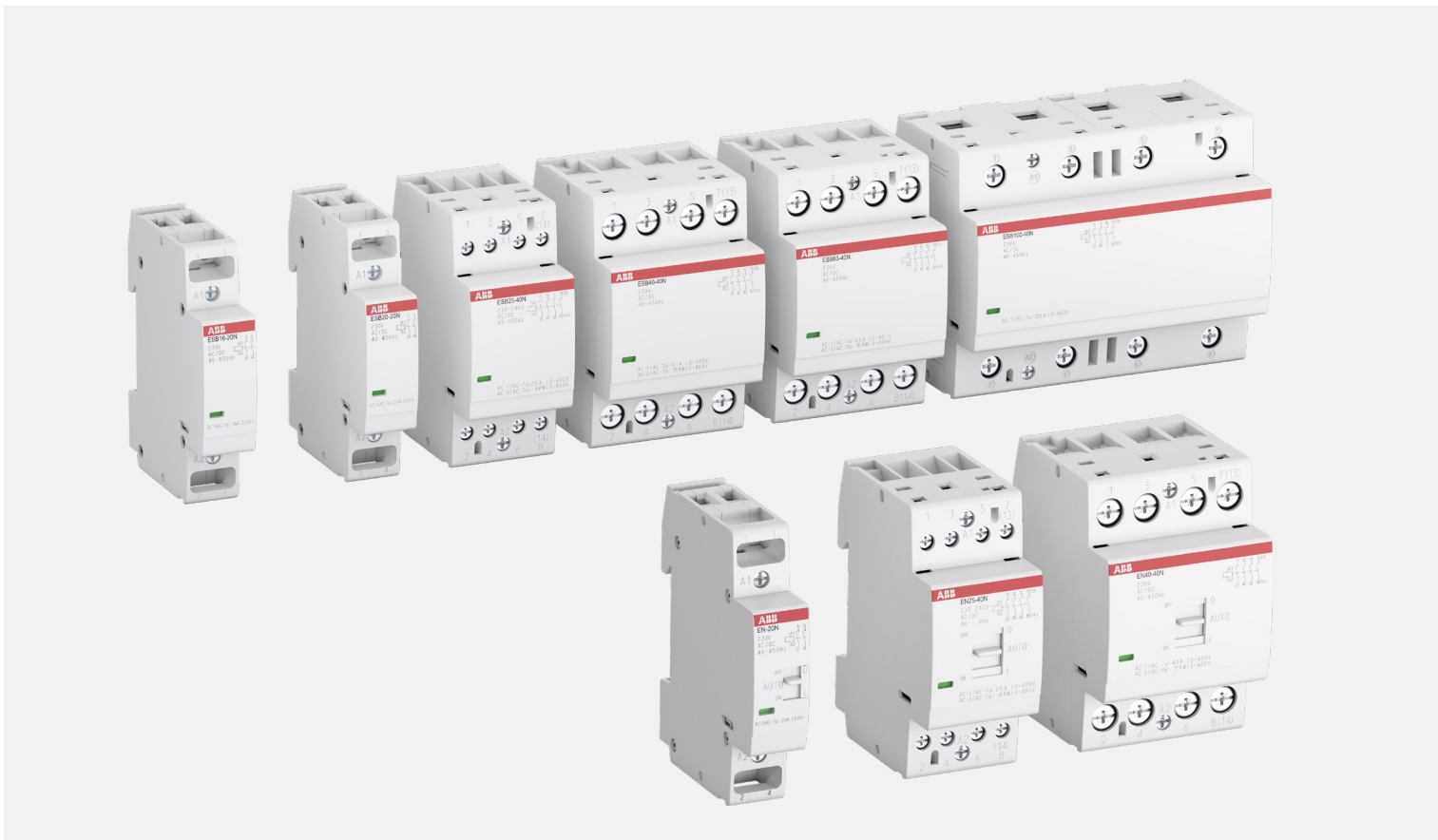

- Quiet and reliable in every application with hum-free AC/DC coils
- Tool-free accessories
- Wide range from 16 to 100 A
- Single- and multipackaging available

Available in a wide range from 16 to 100 A and featuring tool-free accessories, ABB's installation contactors are widely used for switching and controlling lighting, heating, ventilation, EV charging stations, motors and pumps. Quiet and reliable with hum-free AC/DC coils, the all-new installation contactors offer peace of mind in noise-sensitive applications.

Table of contents

Features and benefits	5
Overview contactors	9
Overview accessories	10
Ordering details ESB..N contactors	12
Ordering details EN..N contactors	18
Ordering details accessories	21
Technical data	22
DC switching table	28
Lamp load table	29
Voltage code table	30
Index	31

Installation contactors

A wide range of contactors take noise reduction to new levels



ABB's hum-free installation contactor designs now offer a wider range of ratings from 16 A to 100 A. Widely used in buildings for switching and controlling lighting, heating, ventilation, EV charging stations, motor and pumps, the installation contactors take noise reduction to a new level. With an innovative AC / DC coil design that eliminates hum, a broad selection of common accessories as well as manual and automatic versions, installation contactors offer peace of mind in noise-sensitive applications.



Optimum interface

Quiet and reliable in every application

ABB's hum-free contactors feature innovative AC / DC coils. The range covers ratings from 16 A to 100 A and offers accessories to suit customer requirements in every application. An integrated indicator makes diagnostics quicker and provides reliable information about the contactor's status at a glance.



Easy to install

Simple solution that saves time

Reduce installation time and stock levels, with a universal auxiliary contact block that can be attached to the contactors by hand. Installation contactors fit easily with ABB's System Pro M compact range, making them fully compatible with other modular DIN-rail components.



Global availability

Whatever you need, wherever you need it

Installation contactors are available in single and multi-packs to meet different customer needs and to optimize warehousing space. Every ABB product enjoys expert local support worldwide to make communication easier and delivery faster.

Installation contactors

Features and benefits

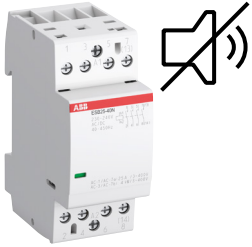

Hum-free operation

With an innovative AC / DC design that eliminates hum, the range meets the needs of applications demanding silent operation, for example hotel rooms and residential buildings.



Single and multiple packaging

The right packaging for your needs- our products are available in a choice of different packaging and delivery quantities. This allows you to warehouse according to your needs and save up to 50% on your inventory.

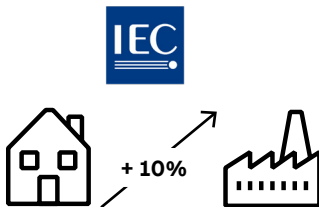

Wide application range

The ESB installation contactors range meets both the industrial standard IEC 60947-4-1 and the household standard IEC 61095 as well as pollution degree class 3. Due to multiple certification and inherent robustness, the contactors can be used in 10% more applications in both residential and industrial settings.

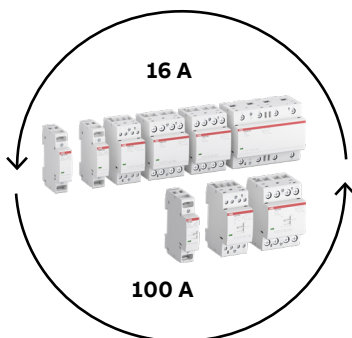

Comprehensive solution

ABB's ESB and EN installation contactors range offers a complete solution from 16 A to 100 A, offering an answer to all customer needs from a single supplier.

With 16 A, 25 A and 100 A versions, tender specifications can be met with competitive pricing.

Installation contactors

Features and benefits

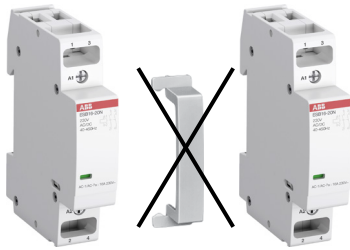

Save up to 15% space with group mounting

ESB16..N, ESB/EN20..N and ESB100..N can be group mounted. There is no need for a distance piece in between contactors, saving both valuable space in cabinets and money.



Built-in protective circuit

Protect the contactor without additional space-demanding components against remote lightning strikes and overvoltages.



Design in accordance with System Pro M

Contactors and accessories are designed according to System pro M range and ABB's modular DIN-rail components and fit in dedicated panels.

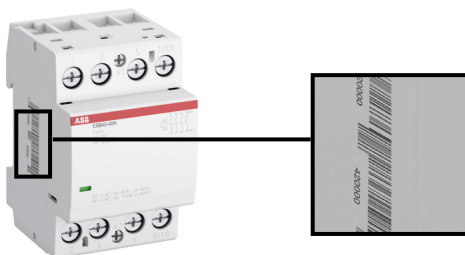

EAN-code for an easy identification

Just scan the EAN-code printed on the side of the devices and save up to 80% time identifying the product in your system. This way, handling and identifying your products in warehouse and cashier system is easy.

Installation contactors

Easy installation and maintenance

ABB's installation contactors come with many features that make installation and maintenance easier. The mechanical Indicator with green and red color for status indication ensures a quick diagnostic of the system. Also, some specialty types feature a manual override functionality with a toggle switch to control independently from control source. Accessories can be mounted tool-free on the contactor, for example auxiliaries, space holders as well as security and safety covers.

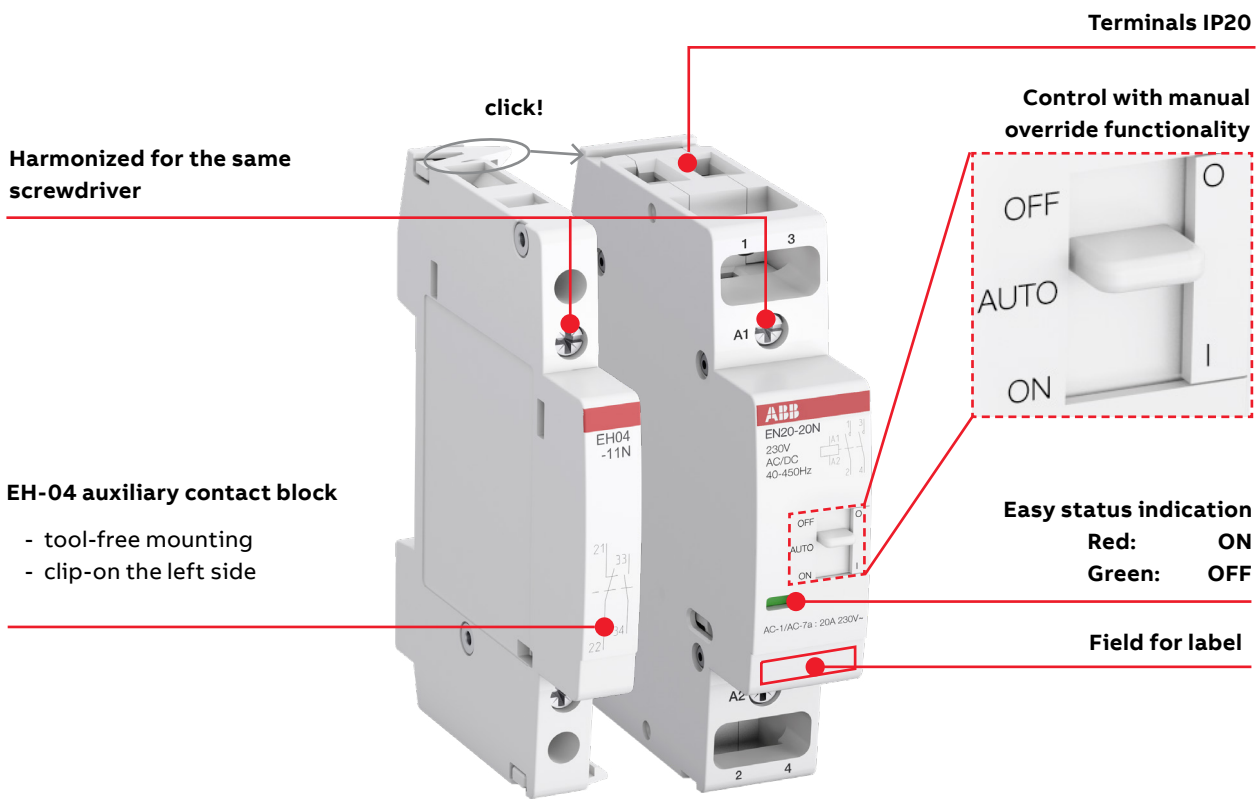

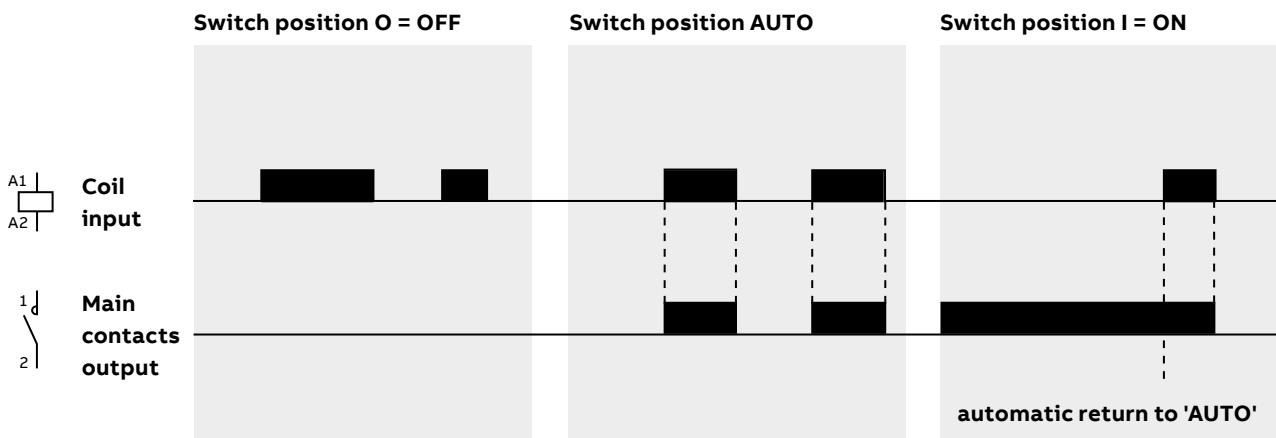

Operation mode EN-versions



Installation contactors

Overview contactors



Type		ESB16..N	ESB20..N EN20..N	ESB25..N EN25..N	ESB40..N EN40..N	ESB63..N	ESB100..N
AC-1/AC-7a (A)		16	20	25	40	63	100
Modular Width		1	1	2	3	3	3/6
Accessories							
 Auxiliary contact blocks	2 NO	EH04-20N	EH04-20N	EH04-20N	EH04-20N	EH04-20N	EH04-20N
	1 NO + 1 NC	EH04-11N	EH04-11N	EH04-11N	EH04-11N	EH04-11N	EH04-11N
 Distance piece	up to 40 °C	-	-	-	-	-	-
	between 40 °C and 55 °C	-	-	ESB-DIS*	ESB-DIS*	ESB-DIS*	-
 Covers		-	-	ESB-PLK24	ESB-PLK40/63	ESB-PLK40/63	-

*If several contactors are mounted adjacently and the duty time is longer than one hour, every second contactor needs a distance piece, Type ESB-DIS (1/2 module). This is not necessary at an ambient temperature ≤ 40 °C.

Installation contactors

Overview accessories

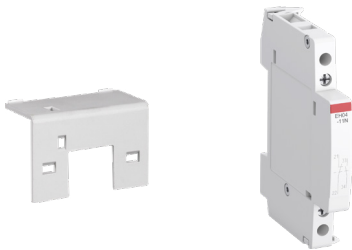

Tool-free accessories

Speed up installation and maintenance time by mounting accessories tool-free to the contactor. Auxiliaries, security safety covers and space holders are easily and quickly installed.

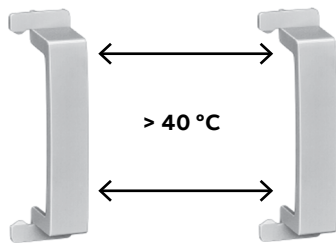

Distance pieces

If the ambient temperature in your control cabinet exceeds 40 °C and the duty time is longer than an hour, you need to use a distance piece between each second contactor for the ESB25..N to ESB63..N.



Sealing covers

Protect the security of your employees/customers' installation with sealing covers. They are available in different sizes and can be clipped on easily.

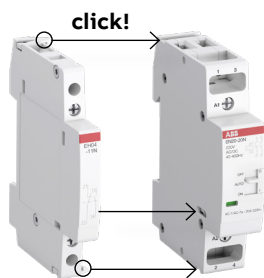

Auxiliary contact blocks

ABB's new range of auxiliary contact blocks are mounted on the left side of the contactors. Simply clip them on - no tools required! Valuable inventory space can be saved with the new auxiliary contact block which is designed to fit all contactors of the range.

The innovative AC/DC coil design eliminates hum and offers peace of mind in noise-sensitive applications like hotel rooms and offices.



ESB16..N installation contactors

Ordering details 16 A, AC-1 /AC-7a, AC/DC operated



ESB16..N

1SBCE01553V0000

The ESB16..N installation contactors are used to control single-phase loads up to 16 A and can be operated by AC or DC voltages. These contactors are made for use in household applications as well as in industrial environment.

ESB16..N series is providing the following benefits:

- Hum-free operation, low power consumption and integrated overvoltage protection.
- Various contact combinations and accessories are available.

Main contacts	Width in number of modular spacings	Rated control circuit voltage ⁽¹⁾	Type	Order code	Pkg qty	Weight (1 pc.)
		V AC/DC				kg
Single packaging						
	1	24	ESB16-20N-01	1SBE111111R0120	1	0.14
		230	ESB16-20N-06	1SBE111111R0620	1	0.14
	1	24	ESB16-02N-01	1SBE111111R0102	1	0.14
		230	ESB16-02N-06	1SBE111111R0602	1	0.14
	1	24	ESB16-11N-01	1SBE111111R0111	1	0.14
		230	ESB16-11N-06	1SBE111111R0611	1	0.14
Multiple packaging						
	1	24	ESB16-20N-01	1SBE111111M0120	12	0.14
		230	ESB16-20N-06	1SBE111111M0620	12	0.14
	1	24	ESB16-02N-01	1SBE111111M0102	12	0.14
		230	ESB16-02N-06	1SBE111111M0602	12	0.14
	1	24	ESB16-11N-01	1SBE111111M0111	12	0.14
		230	ESB16-11N-06	1SBE111111M0611	12	0.14

⁽¹⁾ Other control voltages: see voltage code table and contact ABB for availability of products.

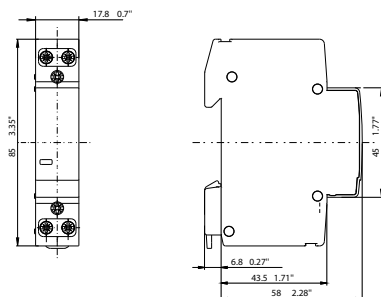

1SBCE50172FF0000

ESB16..N

Dimensions mm, inches

ESB20..N installation contactors

Ordering details 20 A, AC-1 /AC-7a, AC/DC operated



ESB20..N

1SBC101552V0000

The ESB20..N installation contactors are used to control single-phase loads up to 20 A and can be operated by AC or DC voltages. These contactors are made for use in household applications as well as in industrial environment.

ESB20..N series is providing the following benefits:

- Hum-free operation, low power consumption and integrated overvoltage protection.
- Various contact combinations and accessories are available.

Main contacts	Width in number of modular spacings	Rated control circuit voltage ⁽¹⁾ V AC/DC	Type	Order code	Pkg qty	Weight (1 pc.) kg
Single packaging						
	1	24	ESB20-20N-01	1SBE121111R0120	1	0.14
		230	ESB20-20N-06	1SBE121111R0620	1	0.14
	1	24	ESB20-02N-01	1SBE121111R0102	1	0.14
		230	ESB20-02N-06	1SBE121111R0602	1	0.14
	1	24	ESB20-11N-01	1SBE121111R0111	1	0.14
		230	ESB20-11N-06	1SBE121111R0611	1	0.14
Multiple packaging						
	1	24	ESB20-20N-01	1SBE121111M0120	12	0.14
		230	ESB20-20N-06	1SBE121111M0620	12	0.14
	1	24	ESB20-02N-01	1SBE121111M0102	12	0.14
		230	ESB20-02N-06	1SBE121111M0602	12	0.14
	1	24	ESB20-11N-01	1SBE121111M0111	12	0.14
		230	ESB20-11N-06	1SBE121111M0611	12	0.14

⁽¹⁾ Other control voltages: see voltage code table and contact ABB for availability of products.

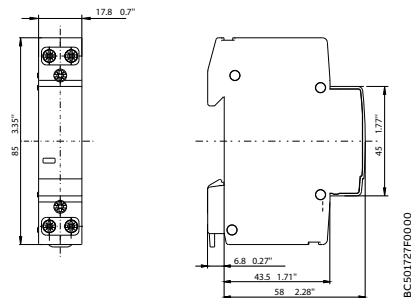

1SBC50127F0000

ESB20..N

Dimensions mm, inches

ESB25..N installation contactors

Ordering details 25 A, AC-1/AC-7a, AC/DC operated



ESB25..N

The ESB25..N installation contactors are used to control single and three-phases loads up to 25 A and can be operated by AC or DC voltages. These contactors are made for use in household applications as well as in industrial environment.

ESB25..N series is providing the following benefits:

- Hum-free operation, low power consumption and integrated overvoltage protection.
- Various contact combinations and accessories are available.

Main contacts	Width in number of modular spacings	Rated control circuit voltage ⁽¹⁾ V AC/DC	Type	Order code	Pkg qty	Weight (1 pc.) kg
	2	24	ESB25-40N-01	1SAE231111R0140	1	0.245
			230 ... 240	ESB25-40N-06	1SAE231111R0640	1
	2	24	ESB25-04N-01	1SAE231111R0104	1	0.245
			230 ... 240	ESB25-04N-06	1SAE231111R0604	1
	2	24	ESB25-22N-01	1SAE231111R0122	1	0.245
			230 ... 240	ESB25-22N-06	1SAE231111R0622	1
	2	24	ESB25-31N-01	1SAE231111R0131	1	0.245
			230 ... 240	ESB25-31N-06	1SAE231111R0631	1
	2	24	ESB25-13N-01	1SAE231111R0113	1	0.245
			230 ... 240	ESB25-13N-06	1SAE231111R0613	1
	2	24	ESB25-40N-01	1SAE231111M0140	6	0.245
			230 ... 240	ESB25-40N-06	1SAE231111M0640	6
	2	24	ESB25-04N-01	1SAE231111M0104	6	0.245
			230 ... 240	ESB25-04N-06	1SAE231111M0604	6
	2	24	ESB25-22N-01	1SAE231111M0122	6	0.245
			230 ... 240	ESB25-22N-06	1SAE231111M0622	6
	2	24	ESB25-31N-01	1SAE231111M0131	6	0.245
			230 ... 240	ESB25-31N-06	1SAE231111M0631	6
	2	24	ESB25-13N-01	1SAE231111M0113	6	0.245
			230 ... 240	ESB25-13N-06	1SAE231111M0613	6

⁽¹⁾ Other control voltages: see voltage code table and contact ABB for availability of products.

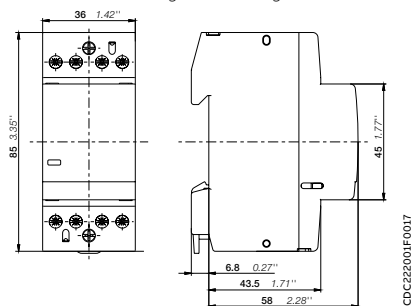

ESB25..N

Dimensions mm, inches

ESB40..N installation contactors

Ordering details 40 A, AC-1/AC-7a, AC/DC operated



ESB40..N

2CDC22008V0017

The ESB40..N installation contactors are used to control single and three-phases loads up to 40 A and can be operated by AC or DC voltages. These contactors are made for use in household applications as well as in industrial environment.

ESB40..N series is providing the following benefits:

- Hum-free operation, low power consumption and integrated overvoltage protection.
- Various contact combinations and accessories are available.

Main contacts	Width in number of modular spacings	Rated control circuit voltage ⁽¹⁾ V AC/DC	Type	Order code	Pkg qty	Weight (1 pc.) kg
Single packaging						
	3	24	ESB40-40N-01	1SAE341111R0140	1	0.405
		230	ESB40-40N-06	1SAE341111R0640	1	0.405
	3	24	ESB40-22N-01	1SAE341111R0122	1	0.405
		230	ESB40-22N-06	1SAE341111R0622	1	0.405
	3	24	ESB40-31N-01	1SAE341111R0131	1	0.405
		230	ESB40-31N-06	1SAE341111R0631	1	0.405
	3	24	ESB40-30N-01	1SAE341111R0130	1	0.385
		230	ESB40-30N-06	1SAE341111R0630	1	0.385
	3	24	ESB40-20N-01	1SAE341111R0120	1	0.370
		230	ESB40-20N-06	1SAE341111R0620	1	0.370
Multiple packaging						
	3	24	ESB40-40N-01	1SAE341111M0140	4	0.405
		230	ESB40-40N-06	1SAE341111M0640	4	0.405
	3	24	ESB40-22N-01	1SAE341111M0122	4	0.405
		230	ESB40-22N-06	1SAE341111M0622	4	0.405
	3	24	ESB40-31N-01	1SAE341111M0131	4	0.405
		230	ESB40-31N-06	1SAE341111M0631	4	0.405
	3	24	ESB40-30N-01	1SAE341111M0130	4	0.385
		230	ESB40-30N-06	1SAE341111M0630	4	0.385
	3	24	ESB40-20N-01	1SAE341111M0120	4	0.370
		230	ESB40-20N-06	1SAE341111M0620	4	0.370

⁽¹⁾ Other control voltages: see voltage code table and contact ABB for availability of products.

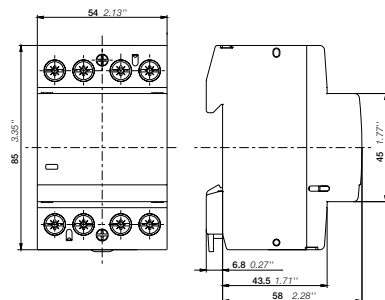

2CDC22003F0017

ESB40..N

Dimensions mm, inches

ESB63..N installation contactors

Ordering details 63 A, AC-1/AC-7a, AC/DC operated



ESB63..N

2CDC22009V0017

The ESB63..N installation contactors are used to control single and three-phases loads up to 63 A and can be operated by AC or DC voltages. These contactors are made for use in household applications as well as in industrial environment.

ESB63..N series is providing the following benefits:

- Hum-free operation, low power consumption and integrated overvoltage protection.
- Various contact combinations and accessories are available.

Main contacts	Width in number of modular spacings	Rated control circuit voltage ⁽¹⁾ V AC/DC	Type	Order code	Pkg qty	Weight (1 pc.) kg
Single packaging						
	3	24	ESB63-40N-01	1SAE351111R0140	1	0.405
		230	ESB63-40N-06	1SAE351111R0640	1	0.405
	3	230	ESB63-31N-06	1SAE351111R0631	1	0.405
	3	230	ESB63-30N-06	1SAE351111R0630	1	0.385
	3	24	ESB63-20N-01	1SAE351111R0120	1	0.37
		230	ESB63-20N-06	1SAE351111R0620	1	0.37
Multiple packaging						
	3	24	ESB63-40N-01	1SAE351111M0140	4	0.405
		230	ESB63-40N-06	1SAE351111M0640	4	0.405
	3	230	ESB63-31N-06	1SAE351111M0631	4	0.405
	3	230	ESB63-30N-06	1SAE351111M0630	4	0.385
	3	24	ESB63-20N-01	1SAE351111M0120	4	0.37
		230	ESB63-20N-06	1SAE351111M0620	4	0.37

⁽¹⁾ Other control voltages: see voltage code table and contact ABB for availability of products.

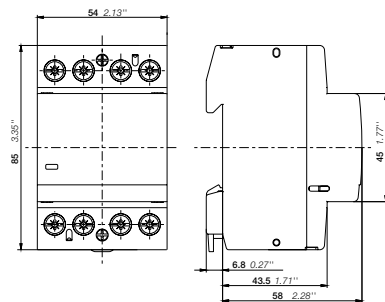

ESB63..N

Dimensions mm, inches

2CDC22003F0017

ESB100..N installation contactors

Ordering details 100 A, AC-1/AC-7a, AC/DC operated

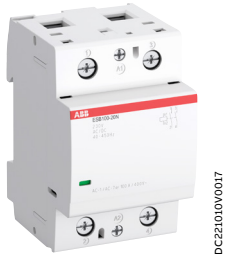

ESB100-20N

2CDC22101V0017



ESB100-40N

2CDC22101V0017

The ESB100..N installation contactors are used to control single and three-phases loads up to 100 A and can be operated by AC or DC voltages. These contactors are made for use in household applications as well as in industrial environment.

ESB100..N series is providing the following benefits:

- Hum-free operation, low power consumption and integrated overvoltage protection.
- Various contact combinations and accessories are available.

Main contacts	Width in number of modular spacings	Rated control circuit voltage	Type	Order code	Pkg qty	Weight (1 pc.)
		V AC/DC				kg
Single packaging						
	6	24	ESB100-40N-01	1SAE661111R0140	1	0.810
		230	ESB100-40N-06	1SAE661111R0640	1	0.810
	3	24	ESB100-20N-01	1SAE361111R0120	1	0.405
		230	ESB100-20N-06	1SAE361111R0620	1	0.405
Multiple packaging						
	3	24	ESB100-20N-01	1SAE361111M0120	2	0.405
		230	ESB100-20N-06	1SAE361111M0620	2	0.405

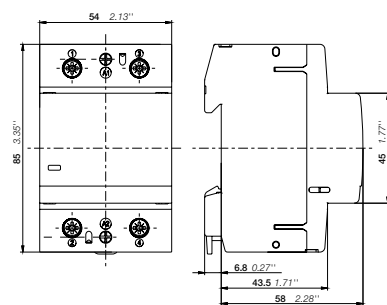

ESB100-20N

2CDC222005F0017

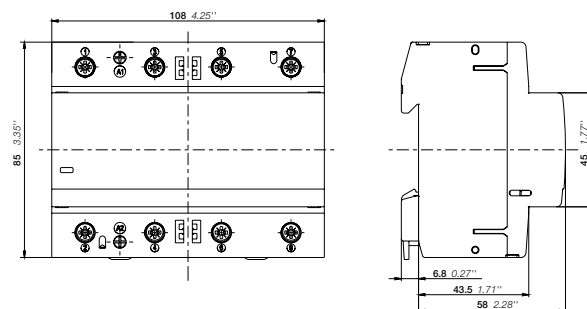

ESB100-40N

2CDC222006F0017

Dimensions mm, inches

EN20..N installation contactors - manually/automatic operated

Ordering details 20 A, AC-1/AC-7a, AC/DC operated



EN20..N

1SBC101553V0000

The EN20..N installation contactors are used to control single-phase loads up to 20 A and can be operated by AC or DC voltages. They have a built-in toggle switch to be operated manually or automatically. These contactors are made for use in household applications as well as in industrial environment.

EN20..N series is providing the following benefits:

- Hum-free operation, low power consumption and integrated overvoltage protection and manual override.
- Various contact combinations and accessories are available.

Main contacts	Width in number of modular spacings	Rated control circuit voltage V AC/DC	Type	Order code	Pkg	Weight
					qty	(1 pc.) kg
Single packaging						
	1	24	EN20-20N-01	1SBE122111R0120	1	0.14
		230	EN20-20N-06	1SBE122111R0620	1	0.14
Multiple packaging						
	1	24	EN20-20N-01	1SBE122111M0120	12	0.14
		230	EN20-20N-06	1SBE122111M0620	12	0.14

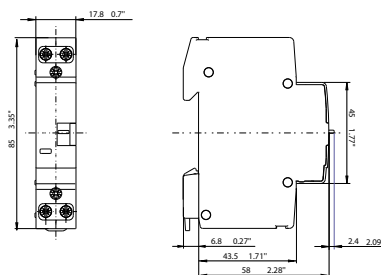

1SBC501729F0000

EN20..N

Dimensions mm, inches

EN25..N installation contactors - manually/automatic operated

Ordering details 25 A, AC-1/AC-7a, AC/DC operated

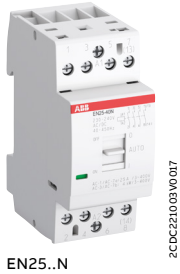

EN25..N

The EN25..N installation contactors are used to control single- and three-phase loads up to 25 A and can be operated by AC or DC voltages. They have a built-in toggle switch to be operated manually or automatically. These contactors are made for use in household applications as well as in industrial environment.

EN25..N series is providing the following benefits:

- Hum-free operation, low power consumption and integrated overvoltage protection and manual override.
- Various contact combinations and accessories are available.

Main contacts	Width in number of modular spacings	Rated control circuit voltage V AC/DC	Type	Order code	Pkg qty	Weight
						(1 pc.) kg
Single packaging						
	2	24	EN25-40N-01	1SAE232111R0140	1	0.250
		230 ... 240	EN25-40N-06	1SAE232111R0640	1	0.240
	2	24	EN25-31N-01	1SAE232111R0131	1	0.250
		230 ... 240	EN25-31N-06	1SAE232111R0631	1	0.240
	2	230 ... 240	EN25-30N-06	1SAE232111R0630	1	0.235
Multiple packaging						
	2	24	EN25-40N-01	1SAE232111M0140	6	0.250
		230 ... 240	EN25-40N-06	1SAE232111M0640	6	0.240
	2	24	EN25-31N-01	1SAE232111M0131	6	0.250
		230 ... 240	EN25-31N-06	1SAE232111M0631	6	0.240
	2	230 ... 240	EN25-30N-06	1SAE232111M0630	6	0.235

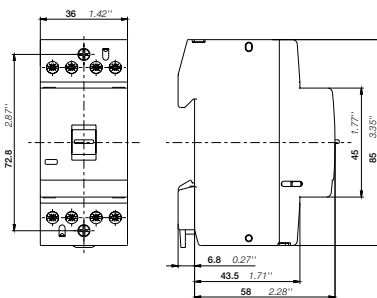

EN25..N

Dimensions mm, inches

2CDC22002 F0017

EN40..N installation contactors - manually/automatic operated

Ordering details 40 A, AC-1/AC-7a, AC/DC operated



EN40..N

2CDC21004V0017

The EN40..N installation contactors are used to control single- and three-phase loads up to 40 A and can be operated by AC or DC voltages. They have a built-in toggle switch to be operated manually or automatically. These contactors are made for use in household applications as well as in industrial environment.

EN40..N series is providing the following benefits:

- Hum-free operation, low power consumption and integrated overvoltage protection and manual override.
- Various contact combinations and accessories are available.

Main contacts	Width in number of modular spacings	Rated control circuit voltage ⁽¹⁾ V AC/DC	Type	Order code	Pkg qty	Weight (1 pc.) kg
Single packaging						
	3	24	EN40-40N-01	1SAE342111R0140	1	0.410
			EN40-40N-06	1SAE342111R0640	1	0.410
	3	24	EN40-31N-01	1SAE342111R0131	1	0.410
			EN40-31N-06	1SAE342111R0631	1	0.410
	3	230	EN40-30N-06	1SAE342111R0630	1	0.410
	3	230	EN40-20N-06	1SAE342111R0620	1	0.375
Multiple packaging						
	3	24	EN40-40M-01	1SAE342111M0140	4	0.410
			EN40-40M-06	1SAE342111M0640	4	0.410
	3	24	EN40-31M-01	1SAE342111M0131	4	0.410
			EN40-31M-06	1SAE342111M0631	4	0.410
	3	230	EN40-30M-06	1SAE342111M0630	4	0.410
	3	230	EN40-20M-06	1SAE342111M0620	4	0.375

⁽¹⁾ Other control voltages: see voltage code table and contact ABB for availability of products.

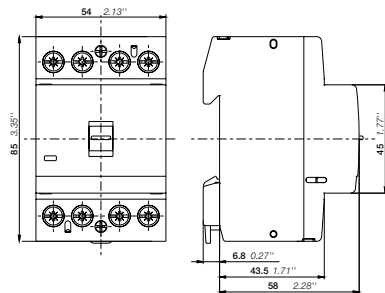

2CDC22004F0017

EN40..N

Dimensions mm, inches

Installation contactors

Ordering details accessories



Auxiliary contact blocks

Suitable for	Auxiliary contacts	Type	Order code	Pkg qty	Weight (1 pc.) kg
Single packaging					
ESB16..N, ESB20..N, ESB25..N, ESB40..N, ESB63..N, ESB100..N, EN20..N, EN25..N, EN40..N		EH04-11N	1SAE901901R1011	1	0.040
		EH04-20N	1SAE901901R1020	1	0.040
Multiple packaging					
ESB16..N, ESB20..N, ESB25..N, ESB40..N, ESB63..N, ESB100..N, EN20..N, EN25..N, EN40..N		EH04-11N	1SAE901901M1011	6	0.040
		EH04-20N	1SAE901901M1020	6	0.040

Accessories

Suitable for	Description	Type	Order code	Pkg qty	Weight (1 pc.) kg
Sealing covers					
ESB25..N, EN25..N	sealing cover	ESB-PLK24	GHE3201903R0001	10	0.002
ESB40..N, ESB63..N, EN40..N	sealing cover	ESB-PLK40/63	GHE3401903R0001	10	0.003
Distance piece					
ESB25..N, ESB40..N, ESB63..N, EN25..N, EN40..N		ESB-DIS ⁽¹⁾	GHE3201902R0001	10	0.002

⁽¹⁾ If several contactors are mounted adjacently and the duty time is longer than one hour, every second contactor needs a distance piece, Type ESB-DIS (1/2 module). This is not necessary at an ambient temperature ≤ 40 °C or on Type ESB16..N, ESB/EN20..N and ESB100..N.

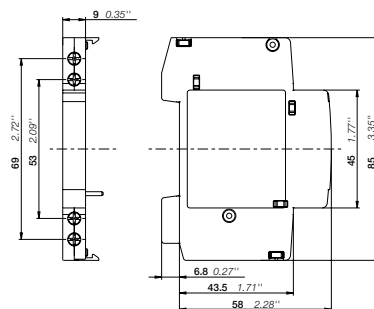

EH04..N
Dimensions mm, inches

Installation contactors

Technical data main circuit

Main circuit – Utilization characteristics according to IEC/EN

Contactor type		ESB16..N	ESB20..N/ EN20..N	ESB25..N/ EN25..N	ESB40..N/ EN40..N	ESB63..N	ESB100..N
Standards		IEC/EN 60947-1, IEC/EN 60947-4-1, IEC/EN 61095					
Rated operational voltage U_e		220 V DC 250 V AC	220 V DC 250 V AC	220 V DC 400 V AC	220 V DC 400 V AC	220 V DC 400 V AC	220 V DC 400 V AC
Rated frequency		DC, 50/60 Hz	DC, 50/60 Hz	DC, 50/60 Hz	DC, 50/60 Hz	DC, 50/60 Hz	DC, 50/60 Hz
AC-1/AC-7a utilization category for air temperature near the contactor ≤ 55 °C							
Rated operational current I_e AC-1/AC-7a	NO	16 A	20 A	25 A	40 A	63 A	100 A
	NC	16 A	20 A	25 A	30 A	30 A	-
Rated operational power AC-1	230 V 1 phase	3.7 kW	4.6 kW	5.8 kW	9.2 kW	14.5 kW	23 kW
	400 V 3 phases	-	-	17.3 kW	27.7 kW	43.6 kW	69.3 kW
AC-3/AC-3e/AC-7b utilization category for air temperature close to contactor ≤ 55 °C							
Rated operational current I_e AC-3/AC-3e/AC-7b	230 V 1 phase	6 A	9 A	9 A	22 A	30 A	-
	400 V 3 phases	-	-	9 A	22 A	30 A	-
Rated operational power AC-3/AC-3e	230 V 1 phase	0.9 kW	1.3 kW	1.3 kW	3.7 kW	5 kW	-
	400 V 3 phases	-	-	4 kW	11 kW	15 kW	-
Rated making capacity acc. to IEC 60947-4-1		10 x I_e /AC-3 13 x I_e /AC-3e	10 x I_e /AC-3 13 x I_e /AC-3e	10 x I_e /AC-3 13 x I_e /AC-3e	10 x I_e /AC-3 13 x I_e /AC-3e	10 x I_e /AC-3 13 x I_e /AC-3e	-
Rated breaking capacity acc. to IEC 60947-4-1		8 x I_e /AC-3 8.5 x I_e /AC-3e	8 x I_e /AC-3 8.5 x I_e /AC-3e	8 x I_e /AC-3 8.5 x I_e /AC-3e	8 x I_e /AC-3 8.5 x I_e /AC-3e	8 x I_e /AC-3 8.5 x I_e /AC-3e	-
Rated short-time withstand current I_{cw} at 40 °C ambient temp. in free air, from a cold state	10 s	48 A	72 A	72 A	176 A	240 A	-
Power loss per pole		0.9 W	1.4 W	2 W	3 W	4.5 W	6 W
Maximum electrical switching frequency	AC-1/AC-7a	300 cycles/h	300 cycles/h	300 cycles/h	300 cycles/h	300 cycles/h	150 cycles/h
	AC-3/AC-7b	600 cycles/h	600 cycles/h	600 cycles/h	600 cycles/h	600 cycles/h	-
Electrical durability	AC-1/AC-7a	150,000 cycles	150,000 cycles	130,000 cycles	150,000 cycles	100,000 cycles	70,000 cycles
	AC-3/AC-7b	150,000 cycles	150,000 cycles	500,000 cycles	150,000 cycles	240,000 cycles	-
Mechanical durability		1,000,000 cycles					

Installation contactors

Technical data short circuit

Short circuit protection with Fuses - Type 1 coordinated

Fuses type	ESB16..N	ESB20..N/ EN20..N	ESB25..N/ EN25..N	ESB40..N/ EN40..N	ESB63..N	ESB100..N
	230 V	230 V	400 V	400 V	400 V	400 V
gG coordinated up to 10kA	20 A	20 A	35 A	63 A	80 A	125 A

Short circuit protection with MCBs - Type 1 coordinated

MCB	Characteristic	Icu	In	ESB16..N	ESB20..N/ EN20..N	ESB25..N/ EN25..N	ESB40..N/ EN40..N	ESB63..N	ESB100..N
				230 V	230 V	400 V	400 V	400 V	400 V
S200	B, C	10 kA	16 A	6 kA	6 kA	6 kA	6 kA	6 kA	6 kA
			20 A	-	6 kA	6 kA	6 kA	6 kA	6 kA
			25 A	-	-	6 kA	6 kA	6 kA	6 kA
			40 A	-	-	-	6 kA	6 kA	6 kA
			63 A	-	-	-	-	6 kA	6 kA
S200M	B, C	15 kA	16 A	10 kA	10 kA	10 kA	10 kA	10 kA	10 kA
			20 A	-	10 kA	10 kA	10 kA	10 kA	10 kA
			25 A	-	-	10 kA	10 kA	10 kA	10 kA
			40 A	-	-	-	10 kA	10 kA	10 kA
			63 A	-	-	-	-	10 kA	10 kA

Short circuit protection with RCDs - Type 1 coordinated

RCD	Characteristic	Icu	In	ESB16..N	ESB20..N/ EN20..N	ESB25..N/ EN25..N	ESB40..N/ EN40..N	ESB63..N	ESB100..N
				230 V	230 V	400 V	400 V	400 V	400 V
DS201	B, C	6 kA	16 A	6 kA	6 kA	6 kA	6 kA	6 kA	6 kA
			20 A	-	6 kA	6 kA	6 kA	6 kA	6 kA
			25 A	-	-	6 kA	6 kA	6 kA	6 kA
			40 A	-	-	-	6 kA	6 kA	6 kA
			63 A	-	-	-	-	6 kA	6 kA
DS201M DS203NC	B, C	10 kA	16 A	10 kA	10 kA	10 kA	10 kA	10 kA	10 kA
			20 A	-	10 kA	10 kA	10 kA	10 kA	10 kA
			25 A	-	-	10 kA	10 kA	10 kA	10 kA
			40 A	-	-	-	10 kA	10 kA	10 kA
			63 A	-	-	-	-	10 kA	10 kA

Installation contactors

Technical data main circuit and control circuit

Main circuit – Utilization characteristics according to UL/CSA

Contactor type		ESB16..N	ESB20..N/ EN20..N	ESB25..N/ EN25..N	ESB40..N/ EN40..N	ESB63..N	ESB100..N
Standards		UL 60947-1, UL 60947-4-1					
General use rating	240 V	16 A	20 A	–	–	–	–
	480 V	–	–	25 A	40 A	63 A	100 A
Motor rating							
Full load current	220 ... 240 V 1 phase	6.9 A	8 A	–	–	–	–
	220 ... 240 V 3 phases	–	–	9.6 A	22 A	28 A	–
	440 ... 480 V 3 phases	–	–	7.6 A	21 A	21 A	–
Horse power rating	220 ... 240 V 1 phase	0.8 hp	1 hp	–	–	–	–
	220 ... 240 V 3 phases	–	–	3 hp	7.5 hp	10 hp	–
	440 ... 480 V 3 phases	–	–	5 hp	15 hp	15 hp	–
Short-circuit protection for contactors without thermal O/L relay - Motor protection excluded							
Fuse rating		20 A	20 A	25 A	40 A	75 A	125 A
Fuse type 480 V/5 kA		K5	K5	K5	K5	K5	K5
Max. electrical switching frequency							
for general use		300 cycles/h	300 cycles/h	300 cycles/h	300 cycles/h	300 cycles/h	150 cycles/h
for motor use		600 cycles/h	600 cycles/h	600 cycles/h	600 cycles/h	600 cycles/h	–

General technical data

Contactor type		ESB16..N	ESB20..N/ EN20..N	ESB25..N/ EN25..N	ESB40..N/ EN40..N	ESB63..N	ESB100..N
Rated insulation voltage U_i							
acc. to IEC 60947-4-1 and VDE 0110 (Gr. C)		400 V	400 V	500 V	500 V	500 V	500 V
Rated impulse withstand voltage U_{imp}							
		6 kV	ESB: 6 kV EN: 6 kV	ESB: 6 kV EN: 4 kV/6 kV with protection cover		6 kV	6 kV
Ambient air temperature range ⁽¹⁾	operation	-25 ... +55 °C	-25 ... +55 °C	-25 ... +55 °C	-25 ... +55 °C	-25 ... +55 °C	-25 ... +55 °C
	storage	-40 ... +80 °C	-40 ... +80 °C	-40 ... +80 °C	-40 ... +80 °C	-40 ... +80 °C	-40 ... +80 °C
Maximum operating altitude permissible		2000 m	2000 m	2000 m	2000 m	2000 m	2000 m
Vibration (sinusoidal) according to IEC/EN 60068-2-6 (Fc)		1 g/3-150 Hz	1 g/3-150 Hz	1 g/3-150 Hz	1 g/3-150 Hz	1 g/3-150 Hz	
Shock (half-sine) according to IEC/EN 60947-1 Annex. Q		Category E	Category E	Category E	Category E	Category E	Category E
Shock (half-sine) according to IEC/EN 60068-2-27 (Ea)		15g/11ms	15g/11ms	15g/11ms	15g/11ms	15g/11ms	15g/11ms

1) If several contactors are mounted adjacently and the duty time is longer than one hour, every second contactor needs a distance piece, Type ESB-DIS (1/2 module). This is not necessary at an ambient temperature ≤ 40 °C or on Type ESB16..N, ESB/EN20..N and ESB100..N

Magnet system characteristics

Contactor type		ESB16..N	ESB20..N/ EN20..N	ESB25..N/ EN25..N	ESB40..N/ EN40..N	ESB63..N	ESB100..N
Coil operating limits acc. to IEC/EN60947-4-1		0.85 ... 1.1 x U_c (at $\theta \leq 55$ °C)					
Rated frequency		DC, 50/60/400 Hz					
Frequency range		DC, 40 ... 450 Hz					
Coil consumption	pull-in	50 Hz	2.5 VA	2.5 VA	4 VA	4.5 VA	60 VA
		60 Hz	2.5 VA	2.5 VA	4 VA	4.5 VA	60 VA
		DC	2.5 W	2.5 W	4 W	5 W	70 W
	holding	50 Hz	2.5 VA	2.5 VA	4 VA	4.5 VA	4.5 VA
		60 Hz	2.5 VA	2.5 VA	4 VA	4.5 VA	4.5 VA
		DC	2.5 W	2.5 W	4 W	5 W	5 W

Installation contactors

Technical data auxiliary circuit

Auxiliary circuit - Utilization characteristics according to IEC/EN

For ambient temperature $T_u = 40\text{ °C}$ if not stated otherwise.

Contactor type		EH04-xxN	
Standards		IEC/EN 60947-1, IEC/EN 60947-5-1	
Rated operational voltage U_e		500 V AC 250 V DC	
Rated frequency		DC, 50/60 Hz	
Rated operational current I_e AC-15	24 V	NO/NC	6 A/6 A
	120 V	NO/NC	6 A/6 A
	240 V	NO/NC	4 A/4 A
	415 V	NO/NC	3 A/3 A
	500 V	NO/NC	2 A/2 A
Rated operational current I_e DC-13	125 V	NO/NC	0.55 A/0.55 A
	250 V	NO/NC	0.27 A/0.27 A
Minimum switching capacity		17 V/5 mA	
Short-circuit protective devices		10 A, gG type fuse	
Mechanical durability		1,000,000 cycles	
Electrical durability	AC-15	240 V/4 A	100,000 cycles
	DC-13	125 V/0.55 A	100,000 cycles
Maximum electrical switching frequency	AC-15		360 cycles/h
	DC-13		360 cycles/h

General technical data

Contactor type		EH04-xxN	
Duty time		100%	
Rated impulse withstand voltage U_{imp} acc. to IEC/EN 60947-1		4 kV	
Rated insulation voltage U_i acc. to IEC/EN 60947-1		500 V	
Pollution category acc. to IEC/EN 60664		2	
Overvoltage category acc. to IEC/EN 60664		Up to III	
Maximum operating altitude permissible		2000 m	
Ambient air temperature range	Operation	Open	-25 °C ... +55 °C
	Storage		-40 °C ... +80 °C
Vibration (sinusoidal) acc. to IEC/EN 60068-2-6 (Fc)		5 g/3-150 Hz	
Shock (half-sine) acc. to IEC/EN 60947-1 Annex. Q		Category E	
Shock (half-sine) acc. to IEC/EN 60068-2-27 (Ea)		15 g/11 ms	

Auxiliary circuit - Utilization characteristics according to UL/CSA

Contactor type		EH04-xxN	
Standards		UL 60947-1, UL 60947-5-1	
Max. operational voltage		600 V AC	
Pilot duty		A600	
Thermal continuous test current		10 A	
General use rating	600 V AC per pole	5 A	





Installation contactors

Technical data auxiliary circuit

Mounting characteristics and conditions for use

Contactor type	EH04-xxN		
Mounting position	Position 1	0°	Yes
	Position 2	180°	Yes
	Position 3	270°	Yes
	Position 4	90°	Yes
	Position 5	standing	Yes
	Position 6	upside down	Not allowed
Mounting on DIN rail	TH35-15 (35 x 15 mm Mounting Rail) acc. to IEC 60715 TH35-7.5 (35 x 7.5 mm Mounting Rail) acc. to IEC 60715		

Auxiliary circuit - Connecting characteristics

Contactor type	EH04-xxN	
Connecting capacity		
 Rigid	1x 1 mm ² ...4 mm ² 2x 1 mm ² ... 1.5 mm ²	
 Flexible with ferrule	1x 1 mm ² ... 1.5 mm ²	
 Flexible with insulated ferrule	-	
 Flexible	1x 1 mm ² ... 1x 2.5 mm ²	
Stranded acc. to UL/CSA	AWG 18.... AWG 12	
Degree of protection	IP20	
Wire stripping length (upper/lower)	17 mm (≤ 1.5mm ² 7 mm) / 9 mm (≤ 1.5mm ² 7 mm)	
Tightening torque	0.9 N·m/ 8 lb.in	
Recommended screw driver	Pozidriv 1	

Installation contactors

DC switching table

Type	Rated operational voltage	Contact	DC-1/A 1-pole	DC-3/A 1-pole	
ESB16-..N	24 V DC	NO	16	12	
	48 V DC		12	6	
	60 V DC		12	4	
	110 V DC		4	1.2	
	220 V DC		0.4	0.2	
	24 V DC	NC	11	5	
			48 V DC	6	2
			60 V DC	4	1.5
			110 V DC	1.2	0.4
			220 V DC	0.2	0.1
ESB20-..N	24 V DC	NO	20	15	
EN20-..N	48 V DC		15	7	
	60 V DC		15	5	
	110 V DC		5	1.5	
	220 V DC		0.5	0.2	
24 V DC	NC	14	6		
		48 V DC	7	3	
		60 V DC	4.5	2	
		110 V DC	1.5	0.6	
		220 V DC	0.2	0.1	

Type	Rated operational voltage	Contact	DC-1/A 3 poles in series	DC-3/A 3 poles in series
ESB25-..N	24 V DC	NO	24	24
EN25-..N	48 V DC		24	24
	60 V DC		24	24
	110 V DC		24	16
	220 V DC		13	4
	24 V DC		NC	24
48 V DC	22			9.4
60 V DC	17.5			7.5
110 V DC	9.5			4.1
220 V DC	3.8			1.6
ESB40-..N	24 V DC	NO	40	40
EN40-..N	48 V DC		40	40
	60 V DC		40	34
	110 V DC		30	18
	220 V DC		15	4.5
ESB63-..N	24 V DC	NO	63	63
	48 V DC		63	47
	60 V DC		60	38
	110 V DC		33	21
	220 V DC		17	5
ESB100-..N	24 V DC	NO	100	100
	48 V DC		100	70
	60 V DC		80	45
	110 V DC		50	25
	220 V DC		35	7

Installation contactors

Lamp load table

Please note that switching lamps is a capacitor load application where high inrush current peaks could occur. These are influenced by the length and cross section of the wire as well as the type of power supply unit and specifications of the lamp brand. For example, long cables can increase the possible number of lamps per pole. The table shows the allowed max. current, at 230 V AC, for one pole and considers already the startup current peaks.

The following selection table shows the current values and the maximum switchable capacitor load for compensated lamps. These two limits have to be considered in the selection of contactors.

	ESB16..N	ESB20..N EN20..N	ESB25..N EN25..N	ESB40..N EN40..N	ESB63..N	ESB100..N
Permitted compensating capacity per phase Cmax [µF]	45	75	100	350	500	650
Lamp types	Maximum load of the current paths during switching of electric lamps I _e [A]					
Incandescent and halogen lamps	4	6	7	20	30	45
Mixing lamps without ballast	4	6	7	20	30	45
Fluorescent lamps with conventional ballast	single lamp uncompensated	14	18	22	36	90
	single lamp parallel compensated	2	3	3.5	10	22
	series compensation, duo circuit	14	18	22	36	90
Fluorescent lamps with electronic ballast or CFL	4	6	7	20	30	45
LED lamps	4	6	7	20	30	45
High pressure mercury-vapor lamps	single lamp without compensation	7	9	11	18	45
	single lamp with parallel compensation	2	3	3.5	10	22
Halogen metal-vapor lamps	single lamp without compensation	7	9	11	18	45
	single lamp with parallel compensation	2	3	3.5	10	22
High pressure sodium-vapor lamps	single lamp without compensation	7	9	11	18	45
	single lamp with parallel compensation	2	3	3.5	10	22
Low pressure sodium-vapor lamps	single lamp without compensation	7	9	11	18	45
	single lamp with parallel compensation	2	3	3.5	10	22

Example for lamp load calculation

Due to many varieties of lamps and ballasts we advice to take the current load as base for reference. The lamp table considers already the inrush peaks and other lamp parameters. Please see the following examples for a reliable project lamp calculation.

Fluorescent lamp with conventional ballast, uncompensated
 the lamp operating current I = 1.5 A, voltage U = 230 V
 1 pole of ESB25..N can be loaded with max. 22 A,
 see lamp table => 22 A / 1.5 A = 14.66 => 14 lamps
 1 pole of ESB20..N can be loaded with max. 18 A,
 see lamp table => 18 A / 1.5 A = 12 lamps

Please use the referring value in the table stated above and divide it with the current stated on the lamp. This will lead to the number of lamps which can be switched.

**Example with picture: ESB25..N used for LED lamps:
 7 A (= 7000 mA) / 85 mA = 82.23 => 82 lamps**



Installation contactors

Voltage code table

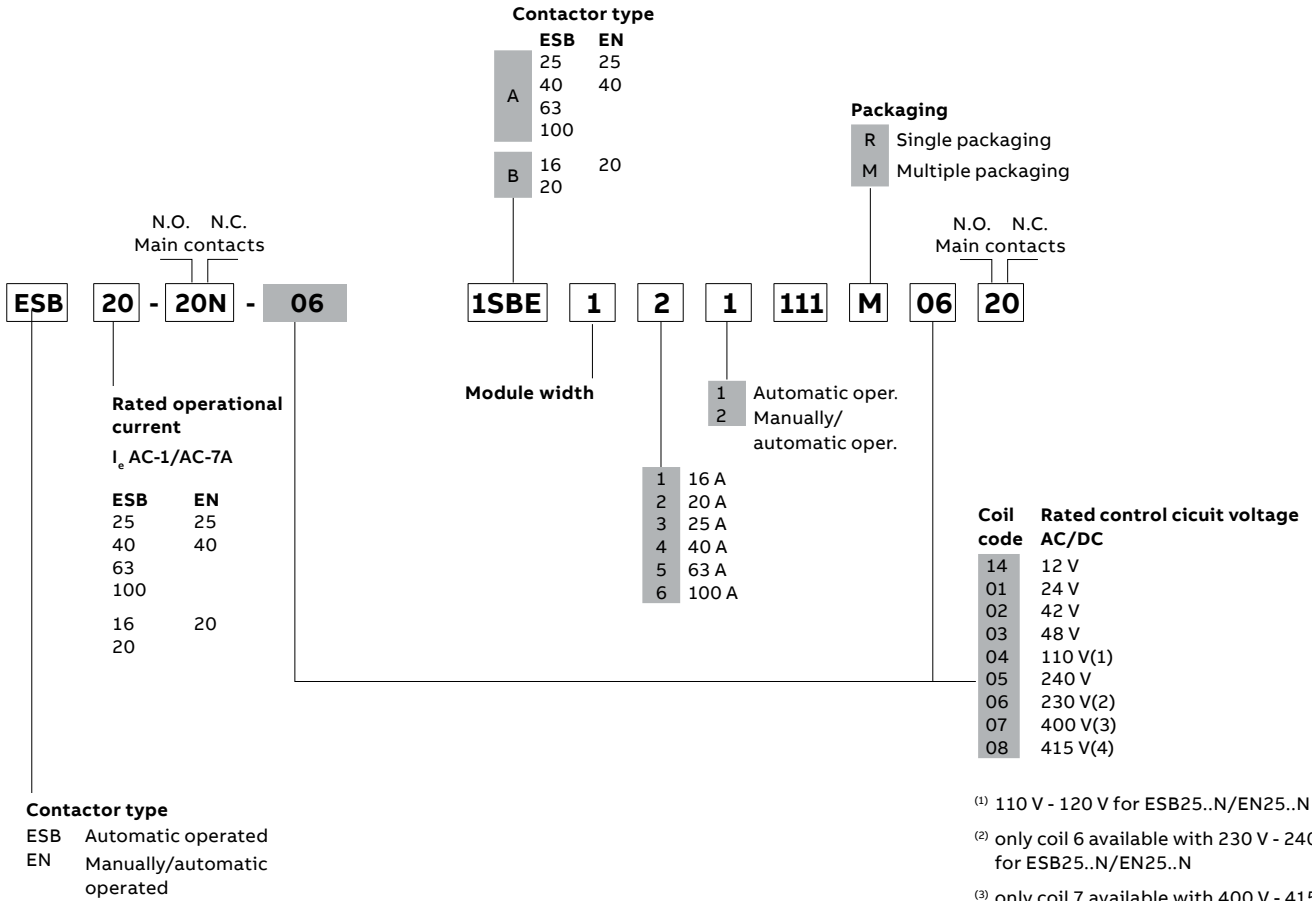

Index

Order code classification

Order code	Type	Page
1SAE231111M0104	ESB25-04N-01	14
1SAE231111M0113	ESB25-13N-01	14
1SAE231111M0122	ESB25-22N-01	14
1SAE231111M0131	ESB25-31N-01	14
1SAE231111M0140	ESB25-40N-01	14
1SAE231111M0604	ESB25-04N-06	14
1SAE231111M0613	ESB25-13N-06	14
1SAE231111M0622	ESB25-22N-06	14
1SAE231111M0631	ESB25-31N-06	14
1SAE231111M0640	ESB25-40N-06	14
1SAE231111R0104	ESB25-04N-01	14
1SAE231111R0113	ESB25-13N-01	14
1SAE231111R0122	ESB25-22N-01	14
1SAE231111R0131	ESB25-31N-01	14
1SAE231111R0140	ESB25-40N-01	14
1SAE231111R0604	ESB25-04N-06	14
1SAE231111R0613	ESB25-13N-06	14
1SAE231111R0622	ESB25-22N-06	14
1SAE231111R0631	ESB25-31N-06	14
1SAE231111R0640	ESB25-40N-06	14
1SAE232111M0131	EN25-31N-01	19
1SAE232111M0140	EN25-40N-01	19
1SAE232111M0630	EN25-30N-06	19
1SAE232111M0631	EN25-31N-06	19
1SAE232111M0640	EN25-40N-06	19
1SAE232111R0131	EN25-31N-01	19
1SAE232111R0140	EN25-40N-01	19
1SAE232111R0630	EN25-30N-06	19
1SAE232111R0631	EN25-31N-06	19
1SAE232111R0640	EN25-40N-06	19
1SAE341111M0120	ESB40-20N-01	15
1SAE341111M0122	ESB40-22N-01	15
1SAE341111M0130	ESB40-30N-01	15
1SAE341111M0131	ESB40-31N-01	15
1SAE341111M0140	ESB40-40N-01	15
1SAE341111M0620	ESB40-20N-06	15
1SAE341111M0622	ESB40-22N-06	15
1SAE341111M0630	ESB40-30N-06	15
1SAE341111M0631	ESB40-31N-06	15
1SAE341111M0640	ESB40-40N-06	15
1SAE341111R0120	ESB40-20N-01	15
1SAE341111R0122	ESB40-22N-01	15
1SAE341111R0130	ESB40-30N-01	15
1SAE341111R0131	ESB40-31N-01	15
1SAE341111R0140	ESB40-40N-01	15
1SAE341111R0620	ESB40-20N-06	15
1SAE341111R0622	ESB40-22N-06	15
1SAE341111R0630	ESB40-30N-06	15

Order code	Type	Page
1SAE341111R0631	ESB40-31N-06	15
1SAE341111R0640	ESB40-40N-06	15
1SAE342111M0131	EN40-31N-01	20
1SAE342111M0140	EN40-40N-01	20
1SAE342111M0620	EN40-20N-06	20
1SAE342111M0630	EN40-30N-06	20
1SAE342111M0631	EN40-31N-06	20
1SAE342111M0640	EN40-40N-06	20
1SAE342111R0131	EN40-31N-01	20
1SAE342111R0140	EN40-40N-01	20
1SAE342111R0620	EN40-20N-06	20
1SAE342111R0630	EN40-30N-06	20
1SAE342111R0631	EN40-31N-06	20
1SAE342111R0640	EN40-40N-06	20
1SAE351111M0120	ESB63-20N-01	16
1SAE351111M0140	ESB63-40N-01	16
1SAE351111M0620	ESB63-20N-06	16
1SAE351111M0630	ESB63-30N-06	16
1SAE351111M0631	ESB63-31N-06	16
1SAE351111M0640	ESB63-40N-06	16
1SAE351111R0120	ESB63-20N-01	16
1SAE351111R0140	ESB63-40N-01	16
1SAE351111R0620	ESB63-20N-06	16
1SAE351111R0630	ESB63-30N-06	16
1SAE351111R0631	ESB63-31N-06	16
1SAE351111R0640	ESB63-40N-06	16
1SAE361111M0120	ESB100-20N-01	17
1SAE361111M0620	ESB100-20N-06	17
1SAE361111R0120	ESB100-20N-01	17
1SAE361111R0620	ESB100-20N-06	17
1SAE661111R0140	ESB100-40N-01	17
1SAE661111R0640	ESB100-40N-06	17
1SAE901901M1011	EH04-11N	21
1SAE901901M1020	EH04-20N	21
1SAE901901R1011	EH04-11N	21
1SAE901901R1020	EH04-20N	21
1SBE111111M0102	ESB16-02N-01	12
1SBE111111M0111	ESB16-11N-01	12
1SBE111111M0120	ESB16-20N-01	12
1SBE111111M0602	ESB16-02N-06	12
1SBE111111M0611	ESB16-11N-06	12
1SBE111111M0620	ESB16-20N-06	12
1SBE111111R0102	ESB16-02N-01	12
1SBE111111R0111	ESB16-11N-01	12
1SBE111111R0120	ESB16-20N-01	12
1SBE111111R0602	ESB16-02N-06	12
1SBE111111R0611	ESB16-11N-06	12
1SBE111111R0620	ESB16-20N-06	12

Order code	Type	Page
1SBE121111M0102	ESB20-02N-01	13
1SBE121111M0111	ESB20-11N-01	13
1SBE121111M0120	ESB20-20N-01	13
1SBE121111M0602	ESB20-02N-06	13
1SBE121111M0611	ESB20-11N-06	13
1SBE121111M0620	ESB20-20N-06	13
1SBE121111R0102	ESB20-02N-01	13
1SBE121111R0111	ESB20-11N-01	13
1SBE121111R0120	ESB20-20N-01	13
1SBE121111R0602	ESB20-02N-06	13
1SBE121111R0611	ESB20-11N-06	13
1SBE121111R0620	ESB20-20N-06	13
1SBE122111M0120	EN20-20N-01	18
1SBE122111M0620	EN20-20N-06	18
1SBE122111R0120	EN20-20N-01	18
1SBE122111R0620	EN20-20N-06	18
GHE3201902R0001	ESB-DIS	21
GHE3201903R0001	ESB-PLK24	21
GHE3401903R0001	ESB-PLK40/63	21

Index

Type code classification

Type	Order code	Page	Type	Order code	Page	Type	Order code	Page
ESB16-02N-01	1SBE111111M0102	12	ESB40-22N-01	1SAE341111M0122	15	EN40-20N-06	1SAE342111M0620	20
	1SBE111111R0102	12		1SAE341111R0122	15		1SAE342111R0620	20
ESB16-02N-06	1SBE111111M0602	12	ESB40-22N-06	1SAE341111M0622	15	EN40-30N-06	1SAE342111M0630	20
	1SBE111111R0602	12		1SAE341111R0622	15		1SAE342111R0630	20
ESB16-11N-01	1SBE111111M0111	12	ESB40-30N-01	1SAE341111M0130	15	EN40-31N-01	1SAE342111M0131	20
	1SBE111111R0111	12		1SAE341111R0130	15		1SAE342111R0131	20
ESB16-11N-06	1SBE111111M0611	12	ESB40-30N-06	1SAE341111M0630	15	EN40-31N-06	1SAE342111M0631	20
	1SBE111111R0611	12		1SAE341111R0630	15		1SAE342111R0631	20
ESB16-20N-01	1SBE111111M0120	12	ESB40-31N-01	1SAE341111M0131	15	EN40-40N-01	1SAE342111M0140	20
	1SBE111111R0120	12		1SAE341111R0131	15		1SAE342111R0140	20
ESB16-20N-06	1SBE111111M0620	12	ESB40-31N-06	1SAE341111M0631	15	EN40-40N-06	1SAE342111M0640	20
	1SBE111111R0620	12		1SAE341111R0631	15		1SAE342111R0640	20
ESB20-02N-01	1SBE121111M0102	13	ESB40-40N-01	1SAE341111M0140	15	EH04-11N	1SAE901901M1011	21
	1SBE121111R0102	13		1SAE341111R0140	15		1SAE901901R1011	21
ESB20-02N-06	1SBE121111M0602	13	ESB40-40N-06	1SAE341111M0640	15	EH04-20N	1SAE901901M1020	21
	1SBE121111R0602	13		1SAE341111R0640	15		1SAE901901R1020	21
ESB20-11N-01	1SBE121111M0111	13	ESB63-20N-01	1SAE351111M0120	16	ESB-DIS	GHE3201902R0001	21
	1SBE121111R0111	13		1SAE351111R0120	16		ESB-PLK24	GHE3201903R0001
ESB20-11N-06	1SBE121111M0611	13	ESB63-20N-06	1SAE351111M0620	16	ESB-PLK40/63		GHE3401903R0001
	1SBE121111R0611	13		1SAE351111R0620	16			
ESB20-20N-01	1SBE121111M0120	13	ESB63-30N-06	1SAE351111M0630	16			
	1SBE121111R0120	13		1SAE351111R0630	16			
ESB20-20N-06	1SBE121111M0620	13	ESB63-31N-06	1SAE351111M0631	16			
	1SBE121111R0620	13		1SAE351111R0631	16			
ESB25-04N-01	1SAE231111M0104	14	ESB63-40N-01	1SAE351111M0140	16			
	1SAE231111R0104	14		1SAE351111R0140	16			
ESB25-04N-06	1SAE231111M0604	14	ESB63-40N-06	1SAE351111M0640	16			
	1SAE231111R0604	14		1SAE351111R0640	16			
ESB25-13N-01	1SAE231111M0113	14	ESB100-20N-01	1SAE361111M0120	17			
	1SAE231111R0113	14		1SAE361111R0120	17			
ESB25-13N-06	1SAE231111M0613	14	ESB100-20N-06	1SAE361111M0620	17			
	1SAE231111R0613	14		1SAE361111R0620	17			
ESB25-22N-01	1SAE231111M0122	14	ESB100-40N-01	1SAE661111R0140	17			
	1SAE231111R0122	14		1SAE661111R0640	17			
ESB25-22N-06	1SAE231111M0622	14	EN20-20N-01	1SBE122111M0120	18			
	1SAE231111R0622	14		1SBE122111R0120	18			
ESB25-31N-01	1SAE231111M0131	14	EN20-20N-06	1SBE122111M0620	18			
	1SAE231111R0131	14		1SBE122111R0620	18			
ESB25-31N-06	1SAE231111M0631	14	EN25-40N-01	1SAE232111R0140	19			
	1SAE231111R0631	14		1SAE232111M0630	19			
ESB25-40N-01	1SAE231111M0140	14	EN25-30N-06	1SAE232111R0630	19			
	1SAE231111R0140	14		1SAE232111M0131	19			
ESB25-40N-06	1SAE231111M0640	14	EN25-31N-01	1SAE232111R0131	19			
	1SAE231111R0640	14		1SAE232111M0631	19			
ESB40-20N-01	1SAE341111M0120	15	EN25-40N-01	1SAE232111R0631	19			
	1SAE341111R0120	15		1SAE232111M0140	19			
ESB40-20N-06	1SAE341111M0620	15	EN25-40N-06	1SAE232111M0640	19			
	1SAE341111R0620	15		1SAE232111R0640	19			

ABB STOTZ-KONTAKT GmbH
Electrification Products Division
Low Voltage Products and Systems

Eppelheimer Straße 82
69123 Heidelberg
Germany

ABB France
Electrification Products Division
Low Voltage Products and Systems

3, rue Jean Perrin
69687 Chassieu cedex
France

**You can find the address of your local sales organization
on the ABB home page**



abb.com/low-voltage

We reserve the right to make technical changes or modify the contents of this document without prior notice. ABB does not accept any responsibility whatsoever for potential errors or possible lack of information in this document.

We reserve all rights in this document and in the subject matter and illustrations contained therein. Any reproduction, disclosure to third parties or utilization of its contents – in whole or in parts – is forbidden without prior written consent of ABB.